



TrangoLINK[®] GigaPlus

6-40 GHz

Split Architecture High Capacity Point-to-Point Microwave Backhaul System



User Manual

Notice

This document contains information that is confidential and proprietary to Trango Systems, Inc. No part of the content of this publication may be reproduced, modified, used, copied, disclosed, conveyed, or distributed to any party in any manner whatsoever without prior written authorization from Trango Systems, Inc. This document is provided as is, without warranty of any kind.

Trademarks

Trango Systems[®], TrangoLINK[®], and TrangoLINK Giga[®] are registered trademarks of Trango Systems, Inc. Other names mentioned in this publication are owned by their respective holders.

Statement of Conditions

The information contained in this document is subject to change without notice. Trango Systems, Inc. shall not be liable for errors contained herein or for incidental or consequential damage in connection with the furnishing, performance, or use of this document or equipment supplied with it.

Information to User

Any changes or modifications of equipment not expressly approved by the manufacturer could void the user's authority to operate the equipment and the warranty for such equipment.

Trango Systems, Inc.

Tel.: +1 (858) 391-0010

Fax: +1 (858) 391-0020

Copyright © Trango Systems, Inc. All rights reserved.

Contents

Tables.....	10
Figures	11
Revision History	14
Preface	15
Reference conventions	16
Warranty Information	16
Contacting Trango Technical Support.....	16
Standards Compliance.....	17
1.0 Product Description	18
Overview.....	18
Ports and Indicators – Indoor Unit.....	20
Location of Serial No. and Out of Band MAC address	23
Ports and Indicators – Outdoor Unit	23
Antenna Connection	25
Remote Mounting.....	25
Combiners for Antenna Sharing.....	25
Power Supply.....	26
Key Features.....	27
Flexible Interfaces and Form Factor.....	27
Traffic Capacity.....	27
Industry Leading System Gain.....	28
Full Licensed band frequency and T/R spacing support	29
Channel Sizes from 3.5 MHz to 80 MHz.....	30
Adaptive Coding and Modulation.....	30
Link Protection through 1+1 Hot Standby.....	31
2.0 Wireless Operation Detail.....	32
Channel Bandwidth	32
Modulation	32
Mean Squared Error (MSE)	32
Adaptive Coding and Modulation (ACM).....	34

Wireless Link Capacity.....	37
Automatic Transmit Power Control (ATPC).....	38
ATPC Max Power & Step Size	38
Transmitter Maximum Power Output.....	38
Transmitter Minimum Power output.....	39
Receiver Maximum Input	40
3.0 Network Operation Detail	41
1+0 Non-Protected Link Configuration	41
1+1 Hot Standby Protected Link Configuration.....	42
Hardware triggered failover	43
Software triggered failover.....	44
User triggered (manual) failover.....	44
Rapid Port Shutdown (RPS).....	45
VLAN Tagging.....	45
Port Mapping (802.1q)	46
Q in Q/Double Tagging and <i>smart_mode</i>	46
Quality of Service (QoS) (802.1p and Diffserv).....	47
Port Priority.....	48
Port Rate Limiting (Ingress)	48
Egress Margin	48
4.0 Link Management.....	50
Overview.....	50
Graphical User Interface (Web Browser).....	51
Command Line Interface (CLI) using SSH, Telnet or Console	54
Changing Password	56
Console Port.....	57
Simple Network Management Protocol (SNMP).....	57
Common Objects for Monitoring and Control.....	58
Firmware Upgrade.....	59
Upgrade Procedure -TFTP	60
Upgrade Procedure -FTP.....	62
Capacity Upgrades.....	64
5.0 Link Planning.....	65
Frequency/Path Planning.....	65
Site Selection.....	65
Licensing	65

6.0	Installation	66
	Safety.....	66
	Installation Process	69
	Preparing for Installation	69
	Tools	69
	Grounding Overview	70
	Power Supply Installation.....	71
	Antenna Installation.....	72
	Install the IDU	72
	Connecting power	73
	Ferrite Installation.....	74
	1+1 Hot Standby IDU Installation.....	75
	HP ODU Installation on Antenna	76
	IF Cable Installation	78
	Weather Proofing Cabling.....	80
	1+1 Hot Standby ODU Installation	81
7.0	Link Configuration	82
	Web Based Configuration.....	83
	Web Based 1+0 Setup	83
	Web Based 1+1 Setup	88
	Adaptive Coding and Modulation (ACM) (Optional).....	90
	Automatic Transmit Power Control (ATPC) (Optional).....	91
	Alarms, RPS and Telnet/TFTP Daemons.....	91
	Ethernet Configuration	94
	Status Monitoring Overview	99
	Link Status	100
	Ethernet Statistics	103
	T1/E1 Statistics	104
	RF Statistics	105
	Diagnostic Options.....	107
	108
	System Log.....	111
	Config View.....	112
	Password Settings	114
	Other Settings.....	114
	Command Line Interface (CLI) Based Configuration	116
	CLI Based 1+0 Configuration	116
	CLI Based 1+1 Hot Standby Configuration	122
	Antenna Alignment	123

CLI Common Task Reference	125
Setting up the In-Band-Management (IBM)	125
Capacity License Activation	128
Automatic Transmit Power Control (ATPC) Configuration (optional).....	128
Check Ethernet and RF port Statistics.....	129
Enable Traps (Optional).....	131
8.0 Troubleshooting	133
Symptom: No Link (Lock = 0 during linktest).....	133
MSE is too high and/or bit errors are showing when running linktest.....	133
Receive Signal Level is too low	134
RF Link is good but packet loss is occurring:.....	135
No direct management using Out of band port	135
No Radio Management connection over the link.....	136
T1/E1 Ports not passing traffic.....	136
Appendix A – Command Line Interface Reference.....	137
Command Keying Overview	137
Key Functions.....	137
Different Node Levels.....	138
View Node.....	138
Config Node.....	140
Debug Node	145
Individual Command Details	146
<i>acm</i>	146
<i>alarm</i>	147
<i>atpc</i>	148
<i>ber</i>	149
<i>bootimage</i>	149
<i>cableloss</i>	150
<i>config</i>	151
<i>custom_profile</i>	153
<i>datapath</i>	153
<i>datapattern</i>	154
<i>date</i>	155
<i>debug</i>	155
<i>default_opmode</i>	156
<i>diagnostics</i>	157
<i>egress_margin</i>	157
<i>eth_info</i>	158
<i>failover</i>	159

<i>fanctrl</i>	160
<i>freq</i>	161
<i>freq_duplex</i>	161
<i>ftp</i>	162
<i>help / ?</i>	163
<i>guard_time</i>	164
<i>httpd</i>	165
<i>ibm</i>	165
<i>ipconfig</i>	166
<i>license</i>	167
<i>link_history</i>	168
<i>linktest</i>	168
<i>loglevel</i>	169
<i>loopback</i>	170
<i>model</i>	171
<i>mse</i>	171
<i>oduled</i>	172
<i>odupower</i>	172
<i>odurxagc</i>	173
<i>opmode</i>	174
<i>passwd</i>	175
<i>port</i>	175
<i>power</i>	177
<i>prompt</i>	178
<i>qos</i>	178
<i>reboot</i>	180
<i>reload</i>	181
<i>remark</i>	181
<i>reset</i>	182
<i>rps</i>	183
<i>rsst</i>	184
<i>siglevel</i>	184
<i>snmpd</i>	186
<i>speed</i>	187
<i>status</i>	191
<i>sync</i>	192
<i>sync_state</i>	192
<i>sysinfo</i>	193
<i>syslog</i>	194
<i>targetrsst</i>	195

<i>tdm</i>	195
<i>telnetd</i>	196
<i>temp</i>	196
<i>ftpd</i>	197
<i>threshold</i>	198
<i>trap</i>	199
<i>uptime</i>	200
<i>utype</i>	201
<i>utype_switch</i>	202
<i>version</i>	203
<i>voltage</i>	203
Appendix B – Product Specifications	205
Dimensions and Weight.....	205
Environmental.....	205
Emissions	205
Reliability	206
Electromagnetic Compliance.....	206
Wireless Compliance.....	206
Wireless Parameters.....	207
Transmitter Power.....	207
1+1 Hot Standby Link Protection	209
Specification	209
Power.....	209
User Interfaces.....	209
Ethernet Parameters.....	210
T1/E1 Parameters.....	210
Appendix C – Cable Wiring	211
Ethernet Cabling.....	211
T1/E1 Cabling.....	212
DB9 Port Interfaces.....	213
DB9 Console cable Pin-outs.....	213
DB9 Alarm Port Pin-outs.....	214
Appendix D – MIB OID Listing.....	215
Appendix E – Part Numbers	229
GigaPlus HP ODU Sub-bands/Tuning Ranges.....	229
Accessories.....	241

Appendix F – Link Install and Commissioning Logs.....242
Appendix G – Declaration of Conformity.....253
Glossary254

Tables

Table 1: TrangoLINK® GigaPlus part numbers	15
Table 2 Combiner Cross Reference	26
Table 3 GigaPlus Band and T/R Spacing Options	29
Table 4 MSE Expected and Maximum Values	33
Table 5 ACM Threshold Table	35
Table 6 Max Link Capacity (Mbps) for non-ACM Speed Settings	37
Table 7 Maximum Set Power Levels by Band and Modulation	39
Table 8 Minimum TX set power by band	39
Table 9 Max Receive Level Input	40
Table 10 Failover Events	43
Table 11 Default Login Passwords	51
Table 12 Recommended Torque	72
Table 13 RSSI to Voltage Conversion	124
Table 14 T1/E1 Cable Wiring	212
Table 15 Console Cable Pin-outs	213
Table 16 Alarm Port Pin Functions	214

Figures

Figure 1 IDU Functional Block Diagram.....	18
Figure 2 ODU Functional Block Diagram	19
Figure 3 Front Panel of GigaPlus IDU	20
Figure 4 Side of IDU (Shows where MAC address can be found)	23
Figure 5 Outdoor Unit Connectors/Indicators (HP Model)	23
Figure 6 Polarization Indicator	24
Figure 7 ODU Label	25
Figure 8 LDPC vs. Reed-Solomon.....	28
Figure 9 Adaptive Coding and Modulation (ACM)	30
Figure 10 1+0 Setup	41
Figure 11 1+1 Setup	42
Figure 12 Web Browser Login	51
Figure 13 System Status Version Page	52
Figure 14 Console Port Setting	57
Figure 15 Windows Start & Telnet	60
Figure 16 Capacity Upgrade in Link Setup Page	64
Figure 17 Site Based Grounding Diagram.....	70
Figure 18 IDU with Rack Ears installed.....	72
Figure 19 Power Connection on Front Panel.....	73
Figure 20 -48 VDC Power Connector Wiring.....	73
Figure 21 Ferrite.....	74
Figure 22 Ferrite Installed.....	74
Figure 23 1+1 Hot Standby (IDUs) with CBLDAT-RIU3	75

Figure 24 Antenna to HP ODU Slip Fit Waveguide connection.....	76
Figure 25 Polarization Indication	77
Figure 26 Latch.....	77
Figure 27 Right Angle N-Connector Mount.....	79
Figure 28 Weather Proofing of cable	80
Figure 29 Complete weather proofing of cable	80
Figure 30 ODUs on SMC combiner (1+1).....	81
Figure 31 Web Interface Login	83
Figure 32 Web Login with Password.....	83
Figure 33 System Information Page (View Mode)	84
Figure 34 System Information Page (Config Mode).....	85
Figure 35 IP Configuration Page	86
Figure 36 Link Setup Page.....	87
Figure 37 Failover Mode Set	88
Figure 38 ACM Setup.....	90
Figure 39 ATPC Setup/ RPS /Telnetd/ tftpd/alarms.....	92
Figure 40 Threshold Setup Page.....	93
Figure 41 Ethernet Setup Page.....	95
Figure 42 QoS Setup Page for Strict mode	96
Figure 43 Qos Setup Page for WRR Mode	98
Figure 44 SNMP Setup Page.....	99
Figure 45 Link Status Page.....	101
Figure 46 Link Test Page.....	102
Figure 47 Ethernet Statistics Page	103
Figure 48 TDM (T1/E1) Statistics Page	104

Figure 49 RF Statistics Page.....	105
Figure 50 Diagnostic Options.....	108
Figure 51 Loopback Auto Page.....	109
Figure 52 Status Display Page.....	110
Figure 53 Status Compare Result Page.....	111
Figure 54 System Log.....	112
Figure 55 Config View.....	113
Figure 56 Password Settings.....	114
Figure 57 Other Settings.....	115
Figure 58 BNC Connector for RSSI Voltage.....	123
Figure 59 EIA/TIA 568A Straight through.....	211
Figure 60 EIA/TIA 568B Cross-Over.....	211
Figure 61 Console Cable Connector.....	213
Figure 62 Alarm Port Pin Identification.....	214

Revision History

Revision	Revision Date	Description
1.0	22 Apr 2010	Initial Release
1.3	6 June 2011	Update to new format and add detail on new features in SW V 1.3
3.0	28 Feb 2012	<p>Update to reflect the following feature changes in SW V3.0 plus bug fixes (see release note for bug fixes)</p> <ul style="list-style-type: none"> - Allow IBM without a VLAN - Custom Speed Profile Support - Support for 5, 8.33, 12.5, and 25 MHz channels sizes - Diffserv (DSCP) and weighted QoS on a per port basis - T1/E1 signal level adjustments - Individual Ethernet Port utilization Statistics - SNMP OID harmonization with ApexPlus 3.0 - Remote Link status reporting - Two level access web interface (view/ config) - Web look and feel changes - Auto loopback diagnostic - Add "link down" threshold parameter - Link Status recording and comparing diagnostic - Reload/reboot in x seconds - Linktest added to web - Web page refresh rate control - BER calculation improvement - Eth port loopback diagnostic - Remove limitation of turning opmode off for a freq change <p>Add note regarding hardware compatibility by revision Add detail on 1+1 configuration (LEDs on GE2) Update Table 3 to add new 7 and 13 GHz TR s</p>
	PENDING	<p>Updated/Improved Sections</p> <ul style="list-style-type: none"> - IBM Tagging - 1+1 Failover setup
3.1	2 Feb 2017	Minor update to policy

Preface

This manual covers the basic configuration and installation of the TrangoLINK® GigaPlus licensed microwave backhaul system,

This document is intended to instruct and assist personnel in the operation, installation and maintenance of the TrangoLINK® GigaPlus microwave backhaul system and related accessories shown in Table 1.

It is recommended that all personnel engaged in such activities be properly trained. Trango Systems disclaims all liability whatsoever, implied or express, for any risk of damage, loss or reduction in system performance arising directly or indirectly out of the failure of the customer, or anyone acting on the customer's behalf, to abide by the instructions, system parameters, or recommendations made in this document.

Part Number	Description
Giga PLUS-IDU-1	TrangoLINK™ Giga PLUS Indoor Unit, 100Mbps Full Duplex, ½ rack mount (All Frequency Versions) ANSI/ETSI
HP1-XX-YYYY-ZZ	TrangoLINK™ High Power (HP1) Outdoor Unit, 6-40 GHz
HP2-XX-YYYY-ZZ	TrangoLINK™ High Power (HP2) Outdoor Unit, 6-40 GHz
PSUPPLY-DT-48	-48 Volt Universal Desktop Power Supply
CBLDAT-RIU3	1+1 Hot Standby Cable for GigaPlus
CBLDAT-RSSI	BNC-M to Banana plug cable for RSSI voltage measurement
GigaPlus-KEY-1	Software Key to Allow Throughputs up to 200Mbps
GigaPlus-KEY-2	Software Key to Allow Throughputs up to 375Mbps
SFP-GigE-C	SFP 1000BaseT Copper RJ45
SFP-GigE-S	SFP Fiber Single Mode Module
SFP-GigE-M	SFP Fiber Multi Mode

Table 1: TrangoLINK® GigaPlus part numbers

Specific part numbers for radio unit sub-bands and band specific accessories such as antennas, combiners and remote mounts can be found in Appendix E.

Reference conventions

This document utilizes several conventions.

All system command references are shown in ***bold italics***.

All references to external publications are shown in **bold**.

Warranty Information

TrangoLINK® GigaPlus units purchased from Trango Systems, Inc. are warranted for one year from date of purchase. Please see www.trangosys.com for a complete description of warranty coverage and limitations.

Extended warranty protection can be purchased through Trango Sales or Customer Service (+1 858-391-0010).

Contacting Trango Technical Support

Should assistance be required or an RMA be required, you may contact the technical support department using the following methods:

Phone: (858) 391-0010 from 8 am to 5 pm Pacific Standard Time.

Email: techsupport@trangosys.com

Web: www.trangosys.com

Standards Compliance

Federal Communications Commission (FCC)

ANSI models of the TrangoLINK® GigaPlus product line have been tested and found to comply with the following FCC standards:

CFR47 Part 15

CFR 47 Part 101

Appendix E shows the specific part numbers that have been tested.

Federal Communications Commission (FCC) Emission Designators

- 5M0D7W for 5 MHz BW rates and all modulations
- 8M3D7W for 8.33 MHz BW rates and all modulations
- 10M0D7W for 10 MHz BW rates and all modulations
- 12M5D7W for 12.5 MHz BW rates and all modulations
- 20M0D7W for 20 MHz BW rates and all modulations
- 25M0D7W for 25 MHz BW rates and all modulations
- 30M0D7W for 27.5/28/30 MHz BW rates and all modulations
- 40M0D7W for 40 MHz BW rates and all modulations
- 50M0D7W for 50 MHz BW rates and all modulations
- 56M0D7W for 55/56/80 MHz BW rates and all modulations

European Telecommunications Standards Institute (ETSI)

ETSI models of the TrangoLINK® GigaPlus product line have been tested and found to comply with the European Telecommunications Standards:

- **EN 302 217-2-1 V1.2.1 (2007-02)**
- **EN 302 217-2-2 V1.2.2 (2007-04)**
- **EN 301 489-1 V1.8.1 (2008-04)**
- **EN 301 489-4 V1.4.1 (2008-09)**
- **EN 60950-1**



These standards cover all the essential requirements of Directive 1999/5/EC. Appendix E shows the specific part numbers that have been tested.

RoHS Compliance

The TrangoLINK® GigaPlus product line complies with the European Union (EU) Directive 2002/95/EC on the Restriction of Hazardous Substances (RoHS).



1.0 Product Description

Overview

The TrangoLINK® GigaPlus is a high-performance split architecture point-to-point wireless microwave system designed for Carrier, Enterprise, and Service Provider networks using the 6-40 GHz licensed spectrum. The system provides a full duplex wireless Layer 2 Ethernet connection with ultra low packet latency and jitter, and supports up to four 10/100/1000BaseT, two Ethernet Fiber interfaces, and eight T1/E1 interfaces for timing or legacy TDM support.

GigaPlus was created to allow the highest performance possible across all standard frequency bands and TR spacings. Each end of the link consists of one compact ½ rack width, 1 RU high Indoor Unit (IDU) and one Outdoor RF unit (ODU), connected via a single coaxial cable up to 1000 feet long. Figures 1 and 2 show the functional block diagram of the system as they are divided between the IDU and ODU.

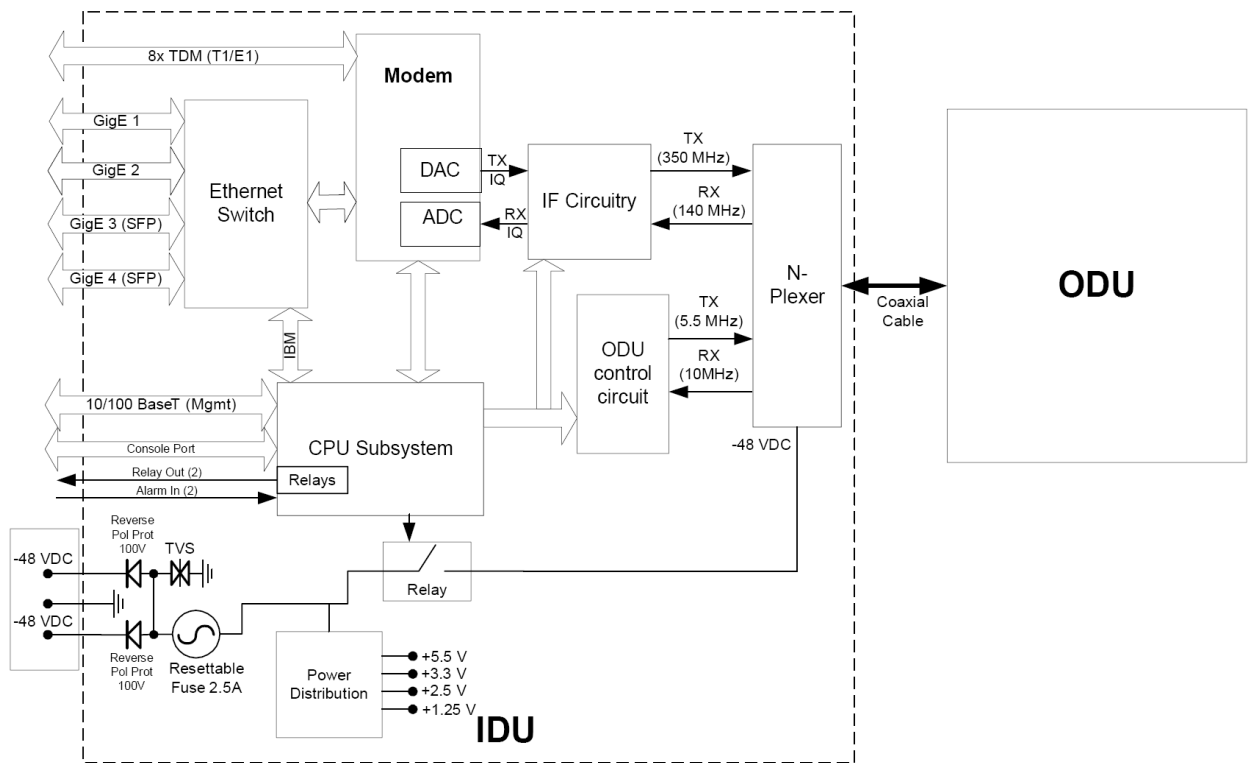

Figure 1 IDU Functional Block Diagram

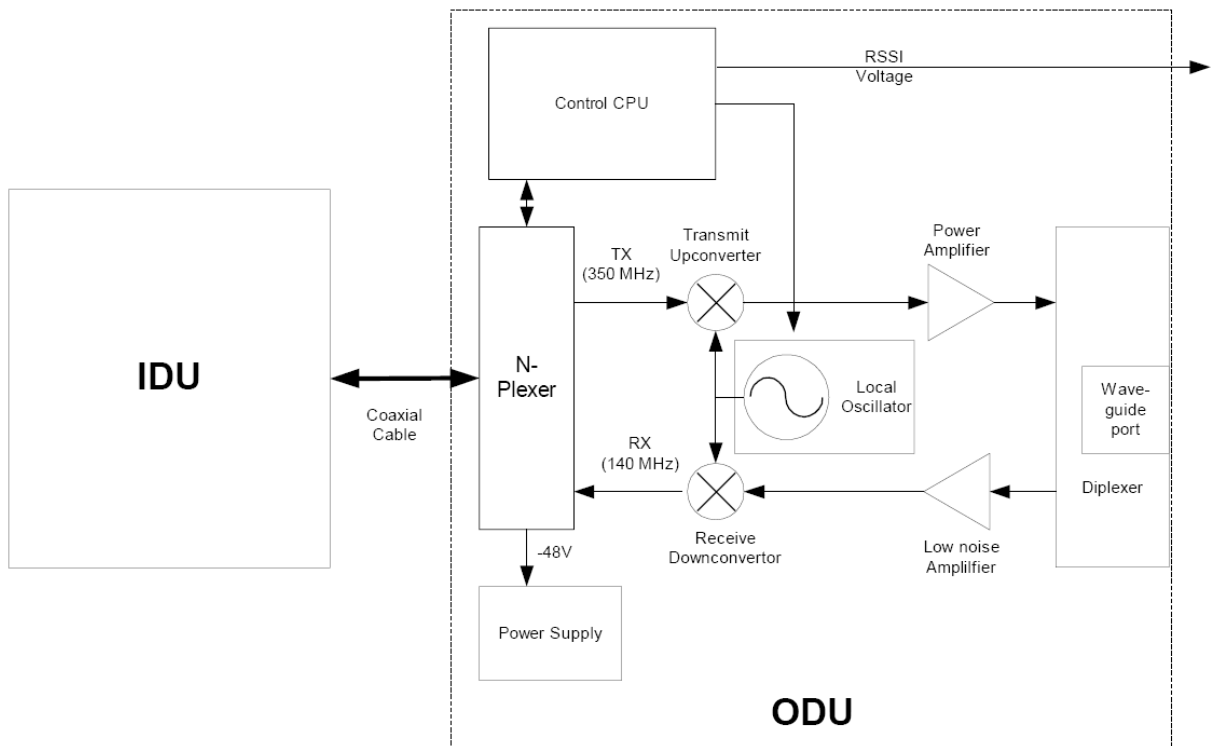

Figure 2 ODU Functional Block Diagram

The TrangoLINK® GigaPlus is a Frequency Division Duplex (FDD) radio which provides low latency of less than 150 microseconds (μ s), over 1 million packets per second, and up to 375 Mbps of full duplex capacity. Standard features include Quality-of-Service (QoS) traffic prioritization to ensure that critical traffic gets through, as well as Adaptive Coding and Modulation (ACM) to improve performance during weather related signal degradation.

GigaPlus supports direct -48 Volt DC dual power to allow for redundant power supplies. The IDU power input has reverse voltage protection to prevent damage and surge suppression circuitry to reduce susceptibility to noise.

Ports and Indicators – Indoor Unit

The Figure below shows the various ports on the GigaPlus IDU.

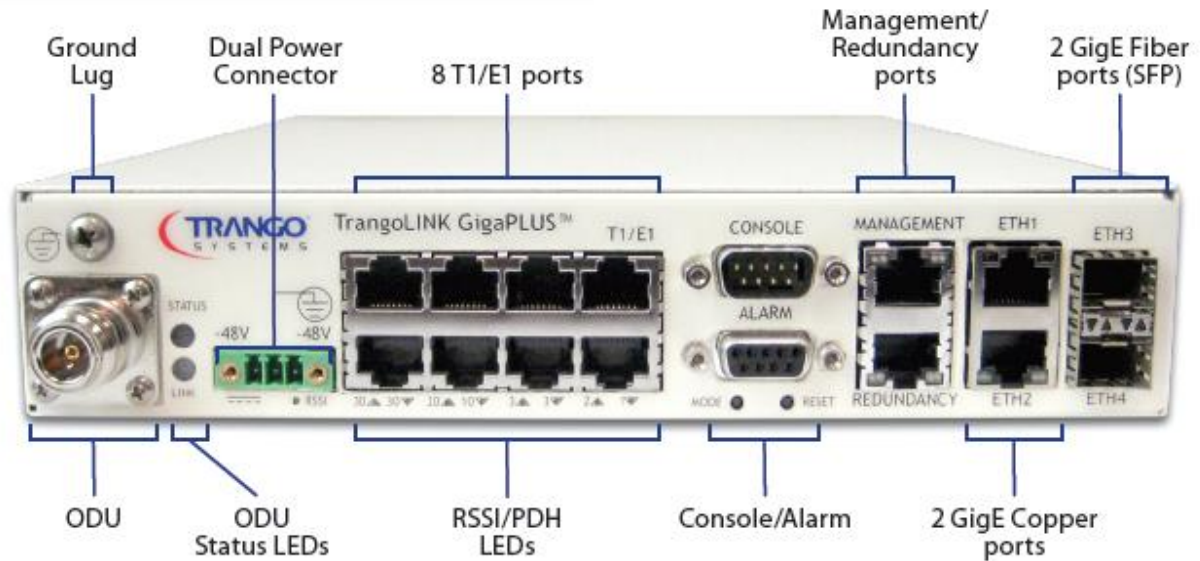

Figure 3 Front Panel of GigaPlus IDU

The TrangoLINK™ GigaPLUS front panel interface is described below:

N-Type Connector (ODU): The N-Type Connector connects the IDU to the ODU through coaxial cable. This port carries the transmit and receive IF frequencies, the ODU control signal, and the -48 VDC power to the ODU on the center conductor. N-Male to N-Male cable terminations are required and LMR400 is recommended for most installations.

Ground Lug: Allows for proper grounding of the chassis to the rack, which is earth grounded.

ODU Status LEDs(2): Top LED provides ODU power/PLL lock status while the bottom LED provides RF link status. If the top LED is amber, the ODU is not powered on, not connected, or one of the Phase Locked Loops (PLLs) in the ODU is faulty. If the bottom LED is amber, RF link is not established. If the link is established both LEDs will be green.

Dual Power Connector: This is a three pin pluggable terminal block. The IDU is powered by a -48V power supply (not included). The GigaPlus IDU does support the use of two power supplies for power redundancy.

USING TWO POWER SUPPLIES FOR REDUNDANCY



The positive (+) ground wire on both power supplies should be connected to the center pin of the three pin pluggable terminal block. One negative wire from the first power supply should be connected to the left pin while the other negative wire of the second power supply should be connected to the right pin.

FUSING



The IDU contains two resettable fuses that will automatically open the if the current draw becomes too high, as in a short-circuit condition. One fuse is for the ODU N-Connector, and the other is for the IDU main chassis circuitry. Circuit heating triggers the opening, so the fuse will reset itself after it cools down. If there is a real fault the fuse will open again and the problem must be diagnosed. The fuse is rated for 1.1 amps maximum and will open with 1.6 or greater amps current flowing.

T1/E1 ports (1 – 8): Standard RJ45 connectors break out all the T1/E1 ports into 8 RJ45 120 Ohm connectors.

RSSI/PDH LEDs:

RSSI Operation: By default, the IDU displays the actual ODU Receive Signal Strength by illuminating the LEDs that, when added together, give a the negative dBm indication of the Received Signal Strength.

Example: LEDs “40” “10” and “1” only illuminated indicates an RSSI of -51 dBm since the sum of the LED values is 51.

PDH Operation: Via software command, the LEDs can be multiplexed to display the connection status of the T1/E1 circuit. The arrows indicate the upper (Arrow pointing up) or lower (arrow pointing down) port above the indicator.

Management Ports (RJ45 – 10/100BaseT Autosensing/Auto-negotiating): For out of band Web, SNMP, Telnet, and SSH management.

Redundancy Port: Connect this port to the hot standby IDU using the redundancy cable. **Note:** This port is not a standard Ethernet Port and will not function using a standard Ethernet cable. CBLDAT-RIU3 is required (optional)

Serial Console Port (DB9 male): 1 serial RS-232 port used to manage unit.

Alarms (DB9 female): There are 2 alarm inputs which are CMOS level and are user configurable. There are 2 outputs which are dry contact rated for 50 Volt 1 Amps each.

Mode Switch: The Mode switch operates as follows:

- 1) Hold for more than 2 seconds, but less than 6 seconds, the unit will:
 - a. The IP address will be reset to default to allow access in the event of a forgotten password or IP address.
 - b. The CLI management passwords will be reset to default
 - c. The Web interface passwords will be reset to default.
 - d. The SNMP read/write/trap community strings will be set to defaults.
 - e. The CLI prompt will be reset.
- 2) Hold for more than 6 seconds: The unit will reset the system configuration to the factory default, but **NOT** reset the items it (1) above. The unit **WILL REBOOT** automatically.

RESET: Reboots IDU without disconnecting the power supply.

2x GigE ports: ETH1 and ETH2 ports are the main traffic and In-band Management (IBM) ports. Both are RJ-45 10/100/1000BaseT auto-sensing GigE ports.

2x SFP Port: ETH3 and ETH4 SFP Ports support two additional native 1000BaseT or LC fiber Ethernet connection for traffic and IBM. SFP modules are available to support each as follows:

- a. SFP-GigE-C – Copper RJ45 module to support 1000BaseT
- b. SFP-GigE-S – Single Mode Fiber for long haul
- c. SFP-GigE-M– Multimode Fiber for short haul

Location of Serial No. and Out of Band MAC address



Figure 4 Side of IDU (Shows where MAC address can be found)

Ports and Indicators – Outdoor Unit

The Figure below shows the various ports on the GigaPlus HP ODU. The HP1 and HP2 ODUs have the same ports but slightly different appearance.



Figure 5 Outdoor Unit Connectors/Indicators (HP Model)

Gore™ Air Vent – The air vent is present to provide pressure equalization at high altitudes while preventing moisture from entering the unit. No operator interaction is necessary.



DO NOT TAMPER with the Air Vent. It should not be twisted or removed. Tampering with or damaging the Protective Vent will void the factory warranty.

RSSI Voltage BNC-F Connector – This connector is provided to allow easy antenna alignment when used with a multi-meter and the CBLDAT-RSSI cable. The Voltage present on the connector is directly proportional to the Received Signal Strength in the receiver section of the GigaPlus.

Mounting Latches – Four latches are provided to allow easy attachment of the GigaPlus to the standard antennas, combiners and remote mounts. Two of the latches have keyholes to allow locking the unit to deter theft and/or secure the unit.

Polarization Indicators – The letter V and an arrow are die cast on the ODU housing perimeter to assist in mounting the ODU to the antenna in the correct polarization. If the arrow is pointed up (as shown) or down the ODU is aligned for vertical polarization. If the arrow is pointed left or right then horizontal polarization is being used.

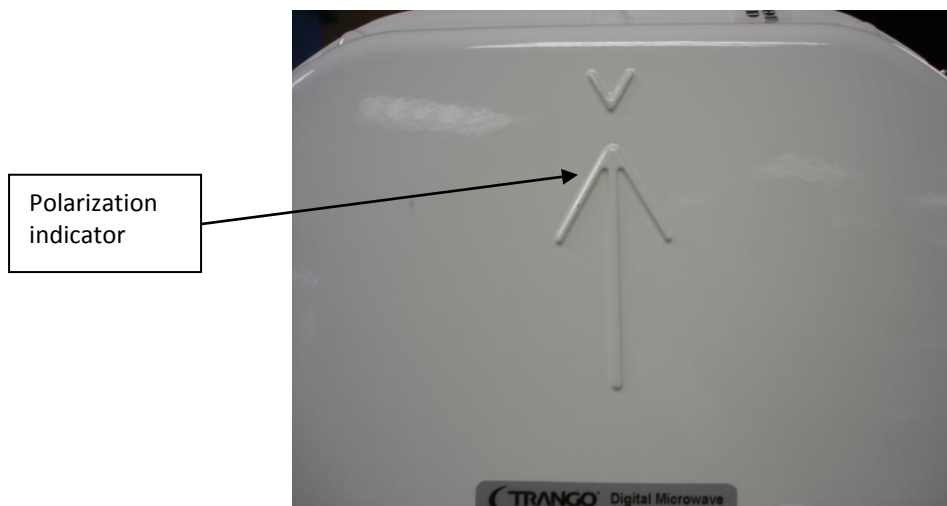

Figure 6 Polarization Indicator

Grounding Lug – ODU - The ground lug provided on the ODU should be connected to the tower/structure leg per the grounding section recommendations.

Labels – The Serial numbers, model, and regulatory compliance information are shown on the ODU labels attached to the ODU exterior.



Figure 7 ODU Label

Antenna Connection

The ODU portion of the GigaPlus utilizes a slip fit connection that makes installation simple. The ODUs are all designed to mount to a circular waveguide antenna or combiner with the exception of the 6 GHz models, which require a rectangular waveguide antenna. For 7 to 40 GHz models, simply rotating the ODU will change the antenna polarization being used. A compatibility list of antennas is provided in Appendix E.

Remote Mounting

When using the GigaPlus HP ODUs with antennas that use a rectangular waveguide interface instead of the slip fit circular waveguide, a Remote Mount plus flex waveguide will be required. The compatible remote mounts are shown in Appendix E. The waveguide flanges are available for mounting all standard waveguide sizes.

Combiners for Antenna Sharing

The GigaPlus ODU is designed with an easy slip fit interface to the antenna. If desired, two units may be connected to the same antenna for 1+1 hot standby application or to aggregate two channels together for more capacity. Trango can provide multiple combiner options based on the customer applications as the table shows below:

Model	LOSS (dB)	LOSS (dB)	ODU1=H	ODU1=H	ODU1=V
	ODU1	ODU 2	ODU2=V	ODU2=H	ODU2=V
SMC-06-xx	1.9	6.5		●	●
SMC-03-xx (6-23 GHz)	3.3	3.3		●	●
SMC-03-xx (26-38 GHz)	4.1	4.1		●	●
OMC-xx	0.5	0.5	●		

Table 2 Combiner Cross Reference

Appendix E gives detailed information on which specific frequency bands are supported for each type of combiner.

Power Supply

Trango can provide power supplies for rack mount applications. The PSUPPLY-1U-48 is a rack mount power supply with 6.5 Ampere capacity that can support multiple co-located GigaPlus units. **The power supply must be kept in a temperature controlled environment within the operating temp of 0 to 40 deg C.**

Key Features

Flexible Interfaces and Form Factor

The GigaPlus is a native Ethernet AND native T1/E1 radio. Capacity can be split to support the Ethernet and T1/E1 circuits, or dedicated to only the Ethernet. There are 2 traffic ports on the front panel that support 10/100/1000BaseT, and 2 that can support 1000BaseT or 1000BaseLX Single or Multimode fiber.

The form factor is small enough to support two units in a 1U rack space, and with support for up to 1000 feet of cable to the ODU, allows more options for tower cable location.

Traffic Capacity

With QAM256 modulation in a 56 MHz channel, the link can support capacities up to 375 Mbps full duplex or 750 Mbps aggregate, with 8 T1/E1 circuits provided for TDM applications.

The base model comes with 100 Mbps Ethernet full duplex capacity and there are two upgrade keys available that can open the entire 375 Mbps capacity:

GigaPlus-Key-1

Description: Unlocks throughput capacity from 100 up to 200 Mbps Full Duplex payload (200 Mbps each direction) – Covers one link – (2 license keys provided)

GigaPlus-Key-2:

Description: Unlocks throughput capacity from 100 Mbps up to Maximum capacity Full Duplex payload (375 Mbps each direction) – Covers one link – (2 license keys provided)

GigaPlus-Key-PDH:

Description: Unlocks the 8 T1/E1 circuits on the front panel. Ethernet capacity will be reduced by the bandwidth required for the T1 and E1 tributaries. – Covers one link – (2 license keys provided)

Industry Leading System Gain

The combination of the High Transmit power and superb receive sensitivity of the ODU provide for one of the highest system gains available on the market today.

The technology behind the high system gain relates to the Low Density Parity Check (LDPC) forward error correction (FEC) coding that was implemented in the GigaPlus design.

The Figure below shows how the Low Density Parity Check (LDPC) coding, which replaces the older Reed-Solomon lock coding, reduces the signal to noise ratio required to achieve a 1E-6 Bit Error Rate (BER). As a result, the receive sensitivity is lowered by the same amount, typically 3 to 4 dB.

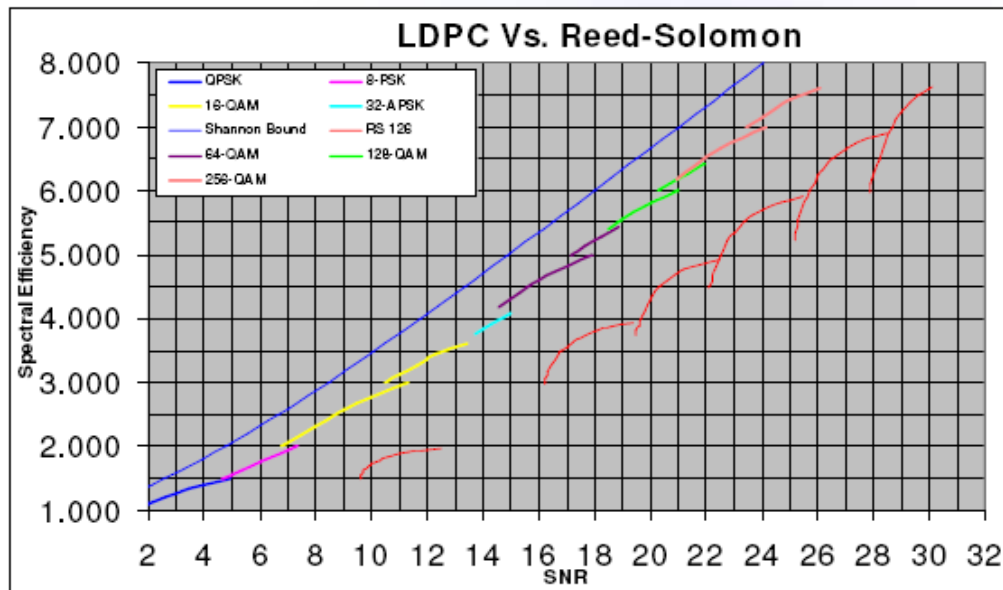

* SNR is for BER of 1e-6

Figure 8 LDPC vs. Reed-Solomon

System gain is one of the most important metrics for a microwave system because it has a direct relationship to the link reliability, antenna size, and transmission distance as shown in the figure below.

1. Smaller Antennas for the same link Distance for same reliability

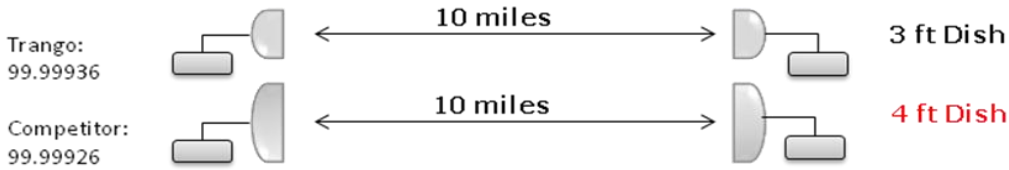

2. Longer Link Distance when using the same antennas for same reliability

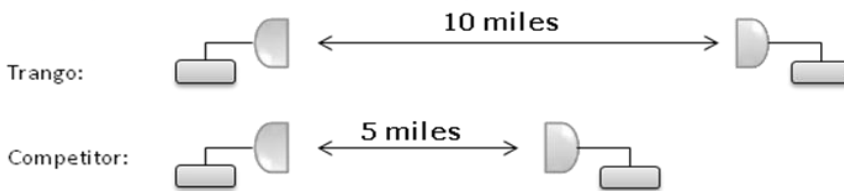

3. Higher link Reliability for same link distance and same antennas

Trango: **5 nines (99.999)**
 Competitor: **4 nines (99.99)**

Full Licensed band frequency and T/R spacing support

All standard frequency bands and T/R spacings are available for this product with no product rollout delays. The Figure below shows the currently supported band and T/R spacings for HP and HP2 ODUs which are used with the GigaPlus. The numbers represent the number of sub-bands for each frequency band.

Models	6 GHz		7 GHz				8 GHz				10 GHz	11 GHz		13 GHz		15 GHz				18 GHz	23 GHz		26 GHz	28 GHz	32 GHz	38 GHz																					
	Transmit/Receive Spacings in MHz																																														
	160	170	240	252.04	300	340	350	154	160	161	168	196	245	300	119/126	151.614	208	266	310	311.32	360	350	490/500	530	266	315	315/322	420	475	490	640	644	728	1010/1008	1092.5/1120	1560	1008	1200	1232	800	1008	1008	812	700	1260		
AP1/EO1/HP ODU	2	2	3	3	4	4	3	3	16	3	5	3	3	6	3	4	2	3	2	3	1	3	4	4	3	3	4	3	4	2	3	3	1	4	3	1	2	3	4	1	3	2	2	4	2		
AP2/EO2/HP2 ODU	4	4	4	4	10	6	3	3	16	3	5	3	3	6	3	4	2	3	2	2	3	1	3	4	4	3	4	3	4	2	3	3	1	4	3	1	2	3	4	1	3	2	2	4	2		
Common sub-banding							●	●	●	●	●	●	●	●	●	●	●	●	●	●	●	●	●	●	●	●	●	●	●	●	●	●	●	●	●	●	●	●	●	●	●	●	●	●	●	●	●

Table 3 GigaPlus Band and T/R Spacing Options

Specific information on the sub-bands is shown in Appendix E.

For HP ODU models the TR spacing can be customized via a software command as long as the new TR spacing and channel bandwidths are within the diplexer range.

See Appendix A for more information

Channel Sizes from 3.5 MHz to 80 MHz

Across all the frequency bands, the system can support channel sizes as low as 3.5 MHz. The table below shows the various channels supported and the Ethernet capacities for each in non-ACM mode. ACM capacities will be slightly less due to the ACM overhead.

Adaptive Coding and Modulation

Adaptive coding and modulation provides error-free hitless changing of the modulation level for a fixed channel width to allow the link to be maintained during heavy weather related fading conditions. Instead of the link dropping and no traffic passing, the link will be maintained with a lower capacity until the fading condition is removed, at which time the link will return to the normal modulation level.

The transitions between modulation levels are controlled by thresholds which are user-modifiable and each transition is made without dropping packets since both ends of the link coordinate the transition automatically.

The Figure below shows the Adaptive Coding and modulation in action.

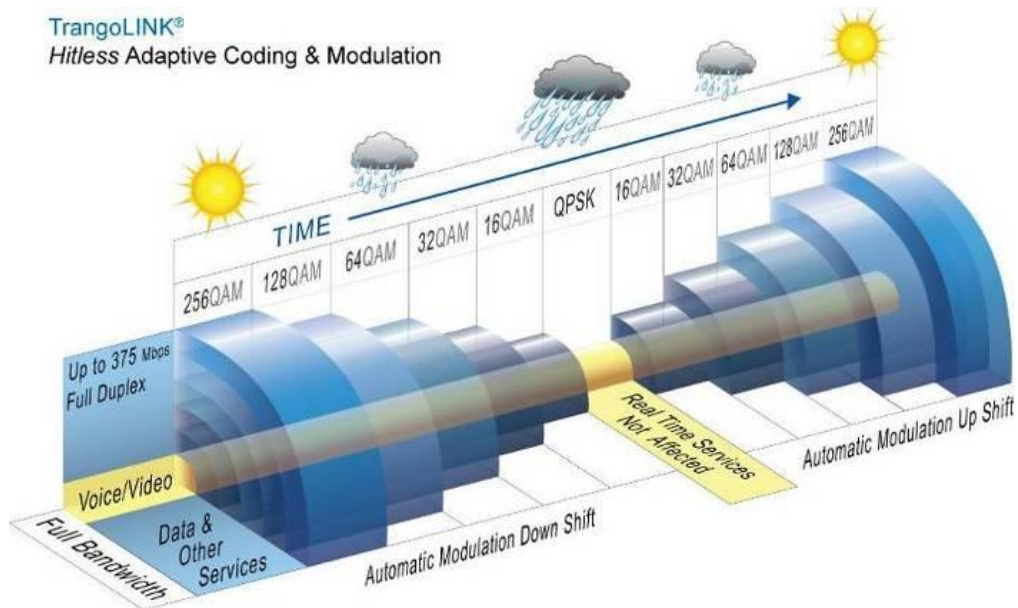

Figure 9 Adaptive Coding and Modulation (ACM)

Link Protection through 1+1 Hot Standby

Two GigaPlus ODUs can be mounted using a combiner directly on a single antenna , and with an optional short jumper cable between the two IDUs, provide 1+1 hot standby functionality to protect against a hardware failure of one GigaPlus IDU, ODU or IF cable .

The hot-standby feature is available on all frequencies and can support layer 2 and layer 3 routed networks to allow immediate routing of the signal to the standby link. The failover time is typically less than 200 milliseconds.

1+1 is available using equal and unequal power division combiners with the same polarization for both ODUs.

2.0 Wireless Operation Detail

Channel Bandwidth

The system supports the following channel bandwidths:

3.5 MHz	25 MHz
5.0 MHz	27.5/28 MHz
7 MHz	30 MHz
8.33 MHz	40 MHz
10 MHz	50 MHz
12.5 MHz	55/56 MHz
13.75/14 MHz	80 MHz
20 MHz	

The speed is changed via the management interface using the speed command or a drop down box in the web interface. Both sides of the link must be changed independently to ensure the RF link is established.

Modulation

The following modulation levels are supported within each of the channel bandwidths shown above:

QAM256
QAM128
QAM64
QAM32
QAM16
QPSK

The modulation is changed via the management interface using the speed command or a drop down box in the web interface. Both sides of the link must be changed independently to ensure the RF link is established.

Mean Squared Error (MSE)

Mean Square Error (MSE) is similar to Signal-to-Noise Ratio (SNR) except that it accounts for **distortion** and **interference** in addition to noise power.

Distortion may come from several sources such as bad Ethernet cables (poor shield, damaged, or low quality), path degradations such as multipath, or Fresnel zone encroachment.

Interference can come from other transmitters on the tower, as well as from sources inside an indoor shelter. High power transmitters inside a shelter can cause interference when near the PoE device or when located very close to the cabling.

There are maximum acceptable MSE values for each modulation which are useful in determining the quality of the link. The MSE value reported is only relevant to one tx-rx path, so the MSE of each tx-rx path must be evaluated to verify the link is operating as expected. The lower the number the better, so a -35dB is better than a -30dB. The table below shows the maximum MSE value to expect in IF Loopback, Normal Operation, and Absolute Maximum.

<i>MSE Expected and Maximum Values (dB)</i>						
	QAM256	QAM128	QAM64	QAM32	QAM16	QPSK
Maximum Expected value IF loopback	-36	-36	-36	-36	-36	-36
Maximum Expected value Normal operation at max power	-34	-33	-32	-30	-30	-29
Absolute Maximum for 1E-6 BER Sensitivity Threshold	-28	-25	-22	-19	-16	-9

Table 4 MSE Expected and Maximum Values

Adaptive Coding and Modulation (ACM)

The ACM feature works in conjunction with the Mean Square Error (MSE) values. Using the **acm** command, the operator enables the ACM function and then sets the speed using the speed command. When ACM is enabled (on) and the link MSE becomes degraded, the radio will automatically shift down in modulation and speed based on the MSE degrade threshold setting shown in Table 5. Since the original set modulation may be QAM256, QAM128, QAM64, QAM32, or QAM16, the table shows each setting and total range of modulation levels that will be used for that setting. The threshold values can be changed by the operator if desired, however the default values shown are the recommended settings.

Speed Setting QAM256		
Modulation	Improve	Degrade
QAM256	NA	-27.2
QAM64	-29.2	-24.3
QAM16	-25.3	-18.5
QPSK	-20.3	NA
Speed Setting using QAM128		
Modulation	Improve	Degrade
QAM128	NA	-27.2
QAM64	-29.2	-24.3
QAM32	-26.3	-21.3
QAM16	-25.3	-18.5
QPSK	-20.3	NA
Speed Setting using QAM64		
Modulation	Improve	Degrade
QAM64	NA	-24.3
QAM32	-26.3	-21.3
QAM16	-25.3	-18.5
QPSK	-20.3	NA
Speed Setting using QAM32		
Modulation	Improve	Degrade
QAM32	NA	-21.3
QAM16	-25.3	-18.5
QPSK	-20.3	NA
Speed Setting using QAM16		
Modulation	Improve	Degrade
QAM16	NA	-18.5
QPSK	-20.3	NA

Table 5 ACM Threshold Table



The ACM feature will automatically shift the modulation level up or down based on the MSE value and the above specified thresholds. If you do not want the radio to automatically change speed settings then disable ACM.

ACM Detailed Description

If the channel conditions degrade due to multipath or fading, the MSE may be affected. This typically occurs during heavy rain and is more pronounced with higher frequencies and longer transmission paths.

If the degrade threshold shown in the table is exceeded, the ACM engine will coordinate a shift of the modulation level down to the next level shown. **No packets will be dropped during this transition** since the two ends of the link are coordinating with each other to ensure that the switch occurs at the same time. Since lower modulation levels are more robust against channel fading and multipath, they can tolerate a higher MSE as is evident from the table.

If the link conditions continue to degrade, the shifts downward will continue until the lowest modulation level, QPSK, has been reached. If further degradation occurs above the maximum MSE (shown previously in Table 5) for QPSK, the link will be dropped and packet loss will occur. If the link MSE starts to improve, however, the ACM engine will gradually shift the modulation level up as the improve thresholds are passed.

When ACM is active the modulation level may be asymmetrical, meaning that one direction may be running at QPSK and the other may be running at the originally set higher modulation such as 256 QAM. This is because the ACM engine acts independently at each endpoint of the link. A low level Binary Phase Shift Keying (BPSK) channel is maintained out of the data path between the two ends of the link to allow very tight coordination of the switches in modulation. Only data traffic capacity in the direction towards the affected receiver will be reduced, maintaining performance on the unaffected direction.

During all ACM operation the transmitter power remains at the set level if ATPC is off. If enabled, ATPC acts normally when ACM is active and may increase or decrease the transmit power based on RSSI levels.

The *acm* command provides configuration of the ACM and must be done on both sides of the link. The *linktest* command from the CLI can be used to view the current TX and RX modulation levels.

Wireless Link Capacity

The table below shows the capacity of the system for each non-ACM speed setting. The capacities for the ACM settings will be approximately 1-2% lower due to the additional overhead of the ACM.

All capacities shown are in Mbps full duplex, meaning that the aggregate bidirectional capacity is twice the number shown.

The capacities shown are also layer 2 using 1518 byte packets for IPV4, rounded to the nearest Mbps. Layer 1 numbers will be higher, especially for small packets:

BW(MHz)	Symbol Rate (Mps)	QPSK	QAM16	QAM32	QAM64	QAM128	QAM256
4	3.75	6	9	15	18	21	23
5	4.3	8	12	19	24	27	31
7	5.6	10	20	25	31	36	40
8.33	7.2	13	26	33	40	46	52
10	8.32	15	30	37	46	53	60
12.5	10.8	20	40	49	60	70	78
14	12.2	22	45	55	67	78	88
20	17.42	31	63	78	96	111	126
25	21.8	39	80	99	120	140	160
28/30	26	47	95	118	142	167	192
40	34.82	63	128	159	192	225	256
50	43	78	157	195	238	277	318
55/56/80	49.5	90	181	225	275	320	365*

***375 Mbps when set to speed 80 qam256, with symbol rate 49.9 Msym/sec**

Table 6 Max Link Capacity (Mbps) for non-ACM Speed Settings

Automatic Transmit Power Control (ATPC)

ATPC and **targetRSSI** work together to control the remote side power output in order to achieve optimal signal strength. ATPC can be enabled or disabled. When enabled, ATPC will adjust the power of the remote side based on the local targetRSSI setting.

If the current RSSI value is lower than the targetRSSI setting of the local radio, the local radio will send commands over the air instructing the remote radio unit to increase its output power to achieve the targetRSSI setting within +/- 2 dB.

If the RSSI value is higher than the targetRSSI setting, the remote radio will be commanded to reduce the power until either the target level is reached within +/- 2 dB or the TX power has hit the minimum level (See Table 8).

ATPC has Step Size and Max Power settings to limit the output power of the unit and prevent a violation of the license.



The power setting cannot be changed once ATPC is enabled. To manually change the power setting, ATPC needs to be disabled.

ATPC Max Power & Step Size

Settings for *ATPC Max Power* and the *ATPC Step Size* control how the ATPC function will behave when attempting to achieve the TargetRSSI. ATPC Max Power is the maximum power setting ATPC can set the power output to when trying to reach the TargetRSSI. ATPC Step Size is the amount of dB per attempt that ATPC can change power output.

Transmitter Maximum Power Output

Maximum Transmitter power output is dependent on the band of operation and the modulation level. Both the HP1 and HP2 ODU models have the same maximum power levels for each band and modulation.

There is no dependency on the channel bandwidth used within a particular band. As an example, the power level for QAM256 within the 6 GHz band is the same for 3.5 MHz channels as it is for 56 MHz channels. The table illustrates this and shows the maximum set power levels for each model family, band, and modulation level.

Modulation Level	Transmitter Maximum Power Output Level (dBm)												
	6 GHz	7 GHz	8 GHz	10 GHz	11 GHz	13 GHz	15 GHz	18 GHz	23 GHz	26 GHz	28 GHz	32 GHz	38 GHz
256 QAM	+24	+24	+24	+21	+21	+20	+20	+19	+19	+19	+16	+16	+16
128 QAM	+25	+25	+25	+22	+22	+21	+21	+20	+20	+20	+17	+17	+17
64QAM	+25	+25	+25	+22	+22	+21	+21	+20	+20	+20	+17	+17	+17
32QAM	+28	+28	+28	+26	+26	+23	+23	+22	+22	+22	+21	+21	+21
16QAM	+28	+28	+28	+26	+26	+23	+23	+22	+22	+22	+21	+21	+21
QPSK	+30	+30	+30	+28	+28	+26	+26	+25	+25	+25	+23	+23	+23

Table 7 Maximum Set Power Levels by Band and Modulation

When ATPC is active, the *atpc_max power* must be set to the maximum power for the highest modulation used.

Transmitter Minimum Power output

The minimum transmit power that can set is limited by the ODU model and is not dependent on the modulation level like the maximum levels are. The table below shows the minimum power levels for each band and model family. The levels are also the minimum levels that ATPC can set the output to when enabled.

HP ODU Model	Transmitter Minimum Power Output Level (dBm)												
	6 GHz	7 GHz	8 GHz	10 GHz	11 GHz	13 GHz	15 GHz	18 GHz	23 GHz	26 GHz	28 GHz	32 GHz	38 GHz
HP1-XX-YYYY-ZZ	+9	+9	+9	NA	+6	+3	+3	+2	+2	+2	+2	+1	+1
HP2-XX-YYYY-ZZ	+0	+0	+0	+0	+0	+0	+0	+0	+0	+0	+0	+0	+0

Table 8 Minimum TX set power by band

Receiver Maximum Input

The maximum receiver RF level, measured by RSSI, is depicted in Table 9 below. If the RSSI value is higher than listed for the modulation being used, packet loss may result. When operating short range links with a high receiver input level, always make sure that the transmitter power is adjusted down from the maximum to ensure the levels shown below are not exceeded, or active ATPC with a target rssi that is at least several dB below the levels shown to provide a safety margin.

Modulation Level	Max RSSI
256 QAM	-24 dBm
128 QAM	-22 dBm
64QAM	-20 dBm
32QAM	-18 dBm
16QAM	-16 dBm
QPSK	-14 dBm

Table 9 Max Receive Level Input

3.0 Network Operation Detail

This section describes key network related elements of the system in detail.

1+0 Non-Protected Link Configuration

The diagram below shows the typical setup of the GigaPlus in a network environment. Although this configuration is call non-protected, it is commonly used in ring architectures which use layer 2 or 3 routing to reroute the traffic the other direction if the link fails.

The Figure below shows the non-protected 1+0 link setup with switches or routers.

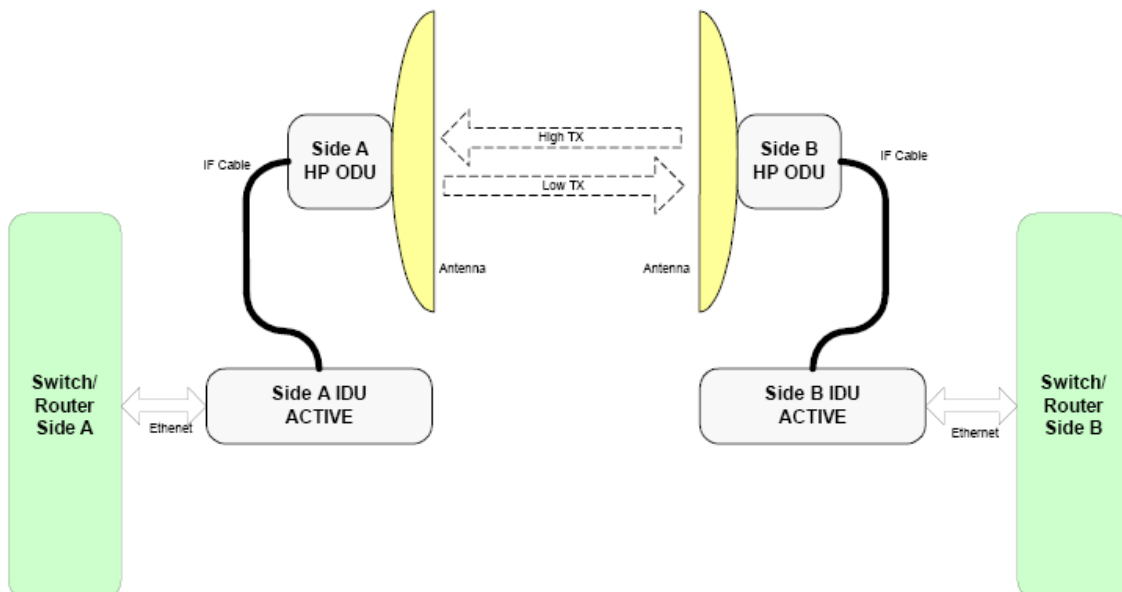

Figure 10 1+0 Setup

1+1 Hot Standby Protected Link Configuration

Figure 11 shows the protected 1+1 hot standby configuration.

This configuration consists of two GigaPlus units at each end of the link. The easiest way to think of a 1+1 setup is a single 1+0 link operating normally with another standby link ready to take over in the event of a failure condition.

The standby units monitor the active link, including receiving the same signal from the far end, but the standby does not transmit a signal unless it becomes the active unit as the result of a failure detection and subsequent failover event. The standby units monitor the health of the active unit by polling it through the redundancy cable part number CBLDAT-RIU3.

If there is an event that triggers a failover from active to standby, both ends of the link will switch to the standby link. This means that a network switch or router capable of Rapid Spanning Tree Protocol (RSTP), BGP or OSPF routing must move the traffic to the standby link on both ends. To assist in this process, Rapid Port Shutdown (RPS) can be enabled on the failed unit as an action after a failover occurs.

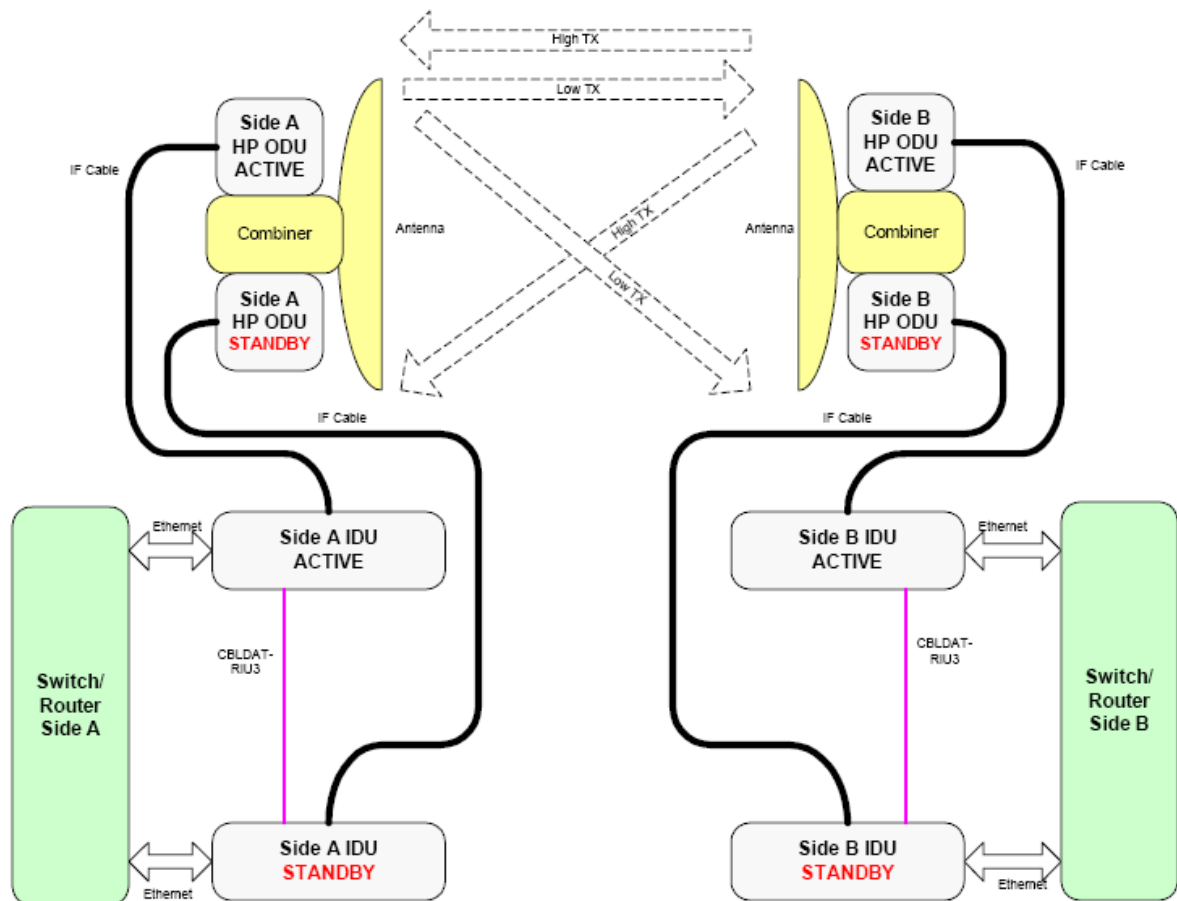

Figure 11 1+1 Setup

The Table below shows the events will cause a failover from active to standby:

Event	Failover Type (local Site)	Failover Type (remote pair)
Modem link lost on Active	Hardware	Hardware
CLI "utype_switch"	Software	Hardware
Power supply failure on Active	Software	Hardware
Reboot on Active	Software	Hardware
ODU PLL failure on Active	Software	Hardware
Violation of threshold setting	Software	Hardware
Link related command (see list)	No failover	Hardware
Power supply failure on Standby	No failover	No failover
Reboot on Standby	No failover	No failover
Odupower on/off on Standby	No failover	No failover
ODU PLL failure on Standby	No failover	No failover
Modem link lost on Standby	No failover	No failover
1+1 cable removal/failure	No failover	No failover
ACM Tx/Rx profile changes	No failover	No failover

Table 10 Failover Events

Hardware triggered failover

In the event that the modem RX link is lost (status changes from "1" to "0"), a hardware triggered failover will occur and the following sequence of actions will occur:

Actions:

- 1) The IF transmit signal will be shut off on the active unit and enabled on the backup unit
- 2) The standby GigaPlus utype will change from standby to active and the previously active unit utype will change to standby.
- 3) The Ethernet port will be shut down on the new standby unit if RPS was enabled.

- 4) The far end of the link will also failover since the transmitter switch will cause the far end to lose lock as well. Steps 1-3 above will repeat for the far end.

Hardware initiated failover to the backup pair will occur on the far end unit due to the small gap in the transmitter being switched from active to standby on the local side. The total time for the failover to occur is typically 150-200 milliseconds.

A hardware failover will only occur the following initial conditions are met, otherwise none of the events in the Table will cause a failover.

- 1) A Standby unit is detected
- 2) The active Radio has its RX locked.
- 3) The election time period is over.
- 4) The guard time has elapsed

Software triggered failover

Software triggered failover is Initiated by the software based on the following conditions. Software failovers will take 3- 5 seconds due to the fact that the events are polled by the operating software inside the unit.

- 1) ODU PLL unlocked
- 2) Violation of a threshold setting when failover is configured as one of the threshold actions.
- 3) Power Supply failure

User triggered (manual) failover

Initiated by user issue CLI/SNMP/web commands as shown below. Typically the only user triggered command that should be executed is the ***utype_switch*** command, which is used when the original active unit is restored or replaced and the operator wants to return it to active status. The other commands are listed to make the operator aware that they will cause an unintentional (and usually undesired) failover.

Commands that will force a failover

1. Using the ***utype_switch*** command to restore the active after a failover
 - a. This command can only be initiated on the Active unit.
 - b. A low level command is sent from Active to Standby unit to turn on transmitter.

2. User commands: When the operator changes the following settings on the active unit, an unintentional failover may occur. It is not recommended to run any of these commands while an active 1+1 link is running:
 - a. *acm enable*
 - b. *bootimage upgrade odu*
 - c. *datapath*
 - d. *data pattern*
 - e. *loopback*
 - f. *opmode*
 - g. *odupower*
 - h. *power*
 - i. *reboot*
 - j. *speed*

Rapid Port Shutdown (RPS)

GigaPlus supports the shutdown of the Ethernet ports to assist in rerouting traffic in the event of a link failure. When enabled at both ends of the link, All Ethernet ports at both ends of the active link will be shut down within 50 mS of the modem lock status changing from “1” to “0” at **either** end of the link.

RPS emulates a cable failure if the entire link is thought of as a cable, and will trigger a routing change when used with a switch or router setup for Rapid Spanning Tree Protocol (RSTP) or another layer 2 routing protocol at both ends, as is normal in a ring architecture. For higher layer routing protocols the ports are normally left active in the event of a link loss.

It is highly recommended that the operator enable ACM when using RPS since the fade margin will be much higher than a non-ACM speed setting, preventing link loss and subsequent rerouting during weather related events.

VLAN Tagging

GigaPlus supports tagged packets with VLAN IDs ranging from 0-4089. The last seven VLAN IDs are used internally as described in the Port Mapping Section below. If In Band Management (IBM) is used, the management traffic can be configured to have a VLAN tag to allow the switch internal to the system to identify packets in the data stream and direct them to the CPU for processing. The VLAN ID for management is user specified using the *ibm* command, with a factory default VLAN ID of 4085. It is recommended that the management traffic be tagged with the highest priority setting to ensure that in the event of network traffic saturation, the management traffic will have precedence (See Quality of Service Section). Untagged IBM is also supported in Firmware release 3.0 and

higher, but there is no guarantee of prioritization when the traffic is on the same port and the user traffic.

Q in Q Support : GigaPlus supports Q in Q, however, due to the port mapping feature being enabled by default, the operator must disable the port mapping. See the Port Mapping and discussion on **smart_mode** below for more information

Port Mapping (802.1q)

The port mapping feature is a fixed setting and provides an additional amount of data security since traffic on the individual Ethernet ports is segmented and isolated from traffic on other Ethernet ports. Port mapping is implemented by using fixed VLAN tags internal to the GigaPlus link. When Ethernet traffic arrives in a port, it may be tagged or untagged. Both tagged and untagged packets are tagged with an additional VLAN Tag depending on which port they arrived at as follows:

GE1: GigE 10/100/1000BaseT port :VLAN ID 4091

GE2: GigE 10/100/1000BaseT port :VLAN ID 4092

GE3: GigE SFP port: VLAN ID 4093

GE4: GigE SFP port: VLAN ID 4094

At the other end of the link, the internal tags are removed and the original packets are sent out unaltered. Essentially the GigaPlus is performing double tagging on packets that have already been tagged.

Port mapping is active when **smart_mode** is “on”.

Q in Q/Double Tagging and **smart_mode**

If the operator wishes to send packets that are already double tagged through the link, then smart mode must be disabled. With **smart_mode** off, all traffic coming in on GE1 will appear at BOTH GE1 and GE2 ports on the far end. **Smart_mode** must be enabled on both ends of the link and it is recommended that only one of the traffic ports GE1 or GE2 be utilized at each end. One added benefit of **smart_mode** being off is that the link can act as a media converter. Side A of the link can be copper RJ45 and side B can be GigE fiber single or multimode. The media conversion will only work for 1000BaseT, as the fiber interface does not support 10/100BaseT modes. It is recommended that both ports be set to the same speed and duplex at both ends of the link.

In Band Management (IBM) with VLAN tagging will not operate with the smart mode turned off. Out of band management and IBM with VLAN tagging off (SW V3.0) will still be available as when Smart Mode is off.

Quality of Service (QoS) (802.1p and Diffserv)

GigaPlus internal switch fabric performs QoS on all incoming packets to provide priority to allow the operator to give priority to certain traffic types. The following fields are used to direct the incoming traffic:

- Layer 2 using the COS bits in the VLAN tag on incoming Ethernet traffic (Tagged traffic only)
- Layer 3 Diffserv (DSCP) using the Differentiated services field in IP packets. The DSCP mapping can be controlled on a port by port basis from CLI or Web.
- Port Priority for untagged traffic

The incoming traffic is mapped into 8 queues (FIFOs) which are emptied into a single data pipe going into the modem and subsequently over the air. The scheduling of the queue traffic into the modem data pipe can be either strict or Weighted Round Robin (WRR)

Strict QoS Mode, which applies to the VLAN COS field only, follows the logic rule below:

COSQ7 > COSQ6 > COSQ5 > COSQ4 > COSQ3 > COSQ2 > COSQ1 > COSQ0

This rule essentially means that the system will empty COSQ7 before sending any COSQ6 packets across the link, and if both COSQ7 and COSQ6 are empty then COSQ5 packets will be sent, etc. Note that while strict priority ensures that **ALL** high priority traffic will go through (up to max burst size and link capacity limits), it may block lower priority traffic or increase the latency significantly for lower priority packets during traffic congestion.

The default priority mapping of the packet will be set as follows:

COS priority 0 → **COSQ0**, Lowest Priority Queue
COS priority 1 → **COSQ1**
COS priority 2 → **COSQ2**
COS priority 3 → **COSQ3**
COS priority 4 → **COSQ4**
COS priority 5 → **COSQ5**
COS priority 6 → **COSQ6**
COS priority 7 → **COSQ7**, Highest Priority Queue

These default mappings can be changed with the **qos** command, allowing the packets to be mapped into any one of the 8 queues based on the COS bit in the VLAN tag. Different priority tags may be mapped into the same queue if desired.

In WRR QoS Mode, both COS and DSCP bits are used. The DSCP field in the IP packet will contain a number from 0-63 in the Type of Service (TOS) field, which can be mapped to a priority level, which is subsequently mapped to a queue.

WRR mode allows weights to be applied to each queue to allow the QoS engine to spend at least some portion of time emptying the queues. This mode is useful for allowing at least some of the lower priority traffic to get through the link and ensuring that **MOST** high priority traffic will go through. Both COS and DSCP fields are monitored on the incoming traffic for assignment of packets to the queues.

The traffic can be classified into 8 priorities (0-7 based on the VLAN tag COS/DSCP bits). This is done external to the GigaPlus unit using a switch or application to set the priority tag field or by the application. Once the tagged traffic with COS/DSCP priority bits set arrives in the GigaPlus Ethernet port, the internal switch will perform prioritization on the traffic by mapping it to one of 8 queues.

Port Priority

The port priority feature allows for untagged traffic arriving into each Ethernet port to have priority level assigned to it. If the arriving traffic is already tagged then that tag priority level will be honored over the port priority. The port priority setting will determine which port traffic is forwarded in the event of more traffic coming into all the ports than the capacity of the system can handle.

Port priority can augment port rate limiting, especially in when ACM is active and the link has downshifted to a lower modulation. The **port** command is used to set the port priority for each port.

Port Rate Limiting (Ingress)

The port rate limiting feature is used to restrict the ingress traffic rate on a specific Ethernet port. This is useful for Service Level Agreements (SLAs) when both ports of the GigaPlus are being used to supply two customers and the channel capacity is limited to less than the sum of the capacity of the two Ethernet ports.

For example, if both ports are set to 1000BaseT, and the RF channel capacity is 375 Mbps, setting GE1 to rate limit of 125 Mbps and GE2 to a rate limit of 250 Mbps will always guarantee that both users have the bandwidth of the channel reserved for them.

Egress Margin

Egress margin is used to fine tune the behavior QoS when using VLAN tagged traffic marked with COS priority (802.1p), or when using port priority to assign priority to untagged traffic on multiple ports.

Traffic coming into the Ethernet ports is bursty by nature and may exceed the radio link capacity if the radio speed is less than the Ethernet line speed (10/100/1000 Mbps). To

reduce or eliminate traffic loss in this case, buffers are used inside the IDU. These are the same buffers used for QoS traffic grooming.

The traffic from all Ethernet ports share the buffers and are serially fed to the radio section at a rate equal to or slightly less than the radio capacity. The egress margin simply controls the egress rate in Mbps from the switch as a percentage added or subtracted for the nominal link capacity. The default is 0% which means that the rate from the switch into the modem section will be equal to the total link capacity. This setting will provide the best throughput for all packet sizes, but may allow some high priority packets to be dropped when the channel is overloaded (input rate > link capacity).

By setting the egress margin to between -2 and -15 percent, the QoS will be enforced and no high priority packets will be dropped. Also, the Egress margin may need to be further reduced for strict QoS modes when datapath is set to Eth+t1 or Eth+E1 since the actual channel capacity for Ethernet is reduced by roughly 12 or 16 Mbps, respectively.

4.0 Link Management

This section describes the various ways to manage and monitor the health and performance of the GigaPlus microwave backhaul link.

Overview

The GigaPlus can be managed through the following methods:

Graphical User Interface (GUI):

Web Browser: Remote access via in band and out of band methods with two level view and configuration level access using any standard web browser such as Internet Explorer, Chrome, Firefox, and Safari .

Command Line Interfaces

SSH – Encrypted remote access via in band and out of band methods with separate view and configuration level access (password protected)

Telnet – Remote access via in band and out of band methods with separate view and configuration level access (password protected)

Console – Local Access using a serial cable for bench configuration with separate view and configuration level access (password protected).

SNMP – Remote control and monitoring via in-band and out-of band methods using any third party Network Management Software (NMS). See Appendix D for details on the MIB and SNMP objects. Standard MIB II System Level and Enterprise MIB Blocks are supported with monitoring for all major link health and traffic related metrics.

Default IP Address

The factory configuration for IP address is 192.168.100.100 for all units, and the IBM default address is 172.16.1.1 for the "A" side unit and 172.16.1.2 for the "B" side unit.

Default Passwords

The default passwords are shown in the table below:

Access mode	Username	Password
CLI View Mode	admin	trango
CLI Config Mode	N/A	trango
CLI Debug Mode	N/A	N/A
Web View Mode	admin	trango
Web Config Mode	config	trango
SNMP Read Community	N/A	public
SNMP Write Community	N/A	private
SNMP Trap	N/A	trapstr

Table 11 Default Login Passwords

Graphical User Interface (Web Browser)

To access the browser interface simply open your Web browser and enter the IP address of the radio. A login window will pop up, requiring a user name and password (Figure 10). Enter the default or modified user name and password then press OK. Either HTTP or HTTPS may be used.

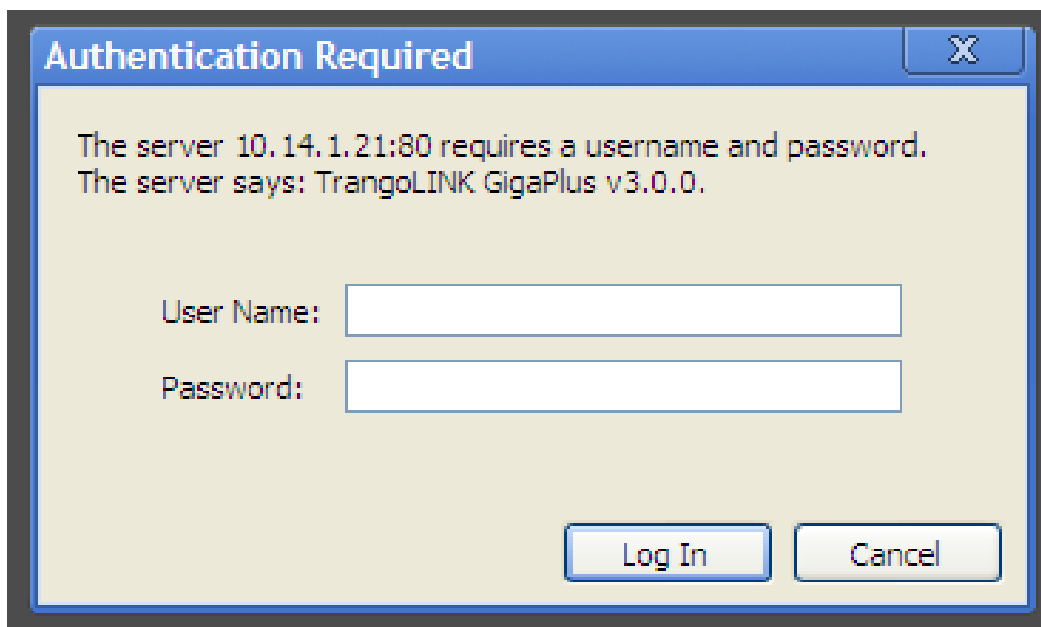

Figure 12 Web Browser Login

The first page to display will be the System Info Page as shown in the Image below:

TRANGO
SYSTEMS

TrangoLINK GigaPlus (10.14.1.21)

Local Active Link: ● RSSI: -57.50 MSE: -33.00 Rx: QAM256
Remote Link: ● RSSI: -56.50 MSE: -34.70 Rx: QAM256

GigaPlus

- Radio Setting
 - Link Setup
 - ACM
 - System
 - Threshold
- Network Settings
 - IP Configuration
 - Ethernet
 - QOS
 - SNMP
- System Status
 - Version**
 - Link Status
 - Link Test
- System Statistics
 - Ethernet Stats
 - TDM Stats
 - RF Stats
- Diagnostics
 - Diagnostic Options
 - Status Display
 - System Log
- User Setting
 - Other

[Config Login](#)

Configuration last saved
November 30 1999 07:06:30.

System Info

TrangoLINK GigaPlus

System Description: GigaPlus-3.0.0
System Uptime: (380056) 1:03:20.56
OBM MAC: 00:01:DE:81:6A:60
IBM MAC: 00:01:DE:81:6A:61

Firmware Version

	Current	Previous
IDU FPGA:	0027040B	0027040B
IDU FW:	3p0r0D022412	3p0r0D022412
IDU OS:	2p6r22b0D022412	2p6r22b0D022412
IDU PIC:	62	62
IDU Modem:	1	1
ODU FW:	150410	150410

IDU / ODU Models

	Serial ID	Model
IDU:	8481376	IDU-GigaPlus-1
ODU:	R15100414	HP-23-1232-A

Figure 13 System Status Version Page

The main format of the GigaPlus Web Interface is shown in Figure 11 above. The layout is designed to allow the operator to view the current link status on all pages. The left side of the display shows various pages organized by function. Each page can be opened and explored by simply clicking on the italicized page name :

Navigation Bar: The navigation bar the left shaded area containing the functional categories. The navigation bar contains the following categories:

- **Radio Setting:** The essential Radio Link setup parameters, TX/RX frequency, transmitter power, ATPC, speed and modulation, as well as the capacity license are found here. Settings for 1+1 failover are found here as well.

- **Network Settings:** The essential Network setup parameters, such as IP address, In Band Management (IBM), Ethernet port settings, Quality of Service(QoS) and SNMP setup are located here.
- **System Status:** Shows most of the basic configuration parameters of the radio, including firmware versions, IDU/ODU models and serial numbers, and Management port MAC addresses. All port and radio link status are shown here as well. The link test command can be run here to view the current RF link state
- **System Statistics:** Counter/status information on all interfaces RF, Ethernet, and T1/E1 ports is displayed. These statistics are refreshed automatically and can be cleared from the web page.
- **Diagnostics:** This section contains pages that show current system settings, the system log which records all the events and user settings, and a special diagnostic export function that produces a text file for Trango Tech Support to use when troubleshooting is required. This folder also has a page to control the loopback functions, view the syslog, and run other special diagnostic functions.
- **User Setting:** User can change the web view and config passwords, change the system remark field and change the web refresh rate.

Command Line Interface (CLI) using SSH, Telnet or Console

All typical radio functions can be managed via the browser interface, but the Command Line Interface (CLI) has additional functionality that facilitates installation and troubleshooting.

The Command Line Interface has 3 nodes: View, Config, and Debug. Logging into the radio via Command Line Interface is covered here briefly, and a complete listing of all CLI commands is provided in Appendix A

Logging into the radio via Command Line Interface is covered here briefly. A complete listing of all CLI commands is provided in Appendix A - Command Line Interface.

Launch Telnet

Open a command prompt (DOS) session on your PC (Windows® Start icon and select “Run”). Open a Telnet session by typing:

```
telnet [ip address of radio]
```

Example:

```
C:>telnet 192.168.100.100
```

Once at the CLI login prompt, type in the login and press enter, then the password and press enter.

```
CLI login: admin
Password: (No characters will be display during input)

Trango System: TrangoLINK GigaPlus Command Line Interface
v1.0.0

(CLI-view) #
```

If the incorrect password is entered during login, the system will allow two more tries before terminating a telnet session. A new session will need to be open to try again.

To terminate a CLI session (Telnet or Console) simply close the console window. A CLI SESSION CAN ALSO BE TERMINATED FROM THE **DEBUG NODE** WITH “EXIT” COMMAND.

View Node : *(CLI-view) #* prompt allows view level only, and no parameters of the radio link can be changed.

Config Node: (CLI-config) #, This node is accessed by typing in the command **config** from the view node. The system will prompt for a password and after successful authentication, the config node is enabled. All configuration settings are changed within the config node.

Any command entered without any parameters returns the current configured values similar to “view” node.

Most configuration changes are applied immediately and do not require a reboot. All config changes must be saved to FLASH memory by issuing the **config save** command. This can be done after all the changes desired are made within a single session

If the configuration is not saved, the system will restore the last saved settings after reboot.



ALL CONFIGURATION CHANGES HAVE TO BE SAVED TO FLASH IN ORDER TO BE PERSISTENT ACROSS A REBOOT. A SINGLE “CONFIG SAVE” COMMAND WILL SAVE ALL CONFIGURATION CHANGES

The operator can go back to the “view” node by using the **exit** command from the config node.

Example:

```
CLI login: admin
```

```
Password:
```

```
Trango System: TrangoLINK GigaPLUS Command Line Interface  
v1.3.0
```

```
(CLI-view)# config
```

```
Password:
```

```
(CLI-config)#
```

```
(CLI-config)#exit
```

```
SUCCESS
```

```
(CLI-view)#
```

The Command Line Interfaces keeps a history of commands used, pressing the up arrow will display previous commands used. The CLI can supports auto-complete of a command being typed by pressing <tab> key. If a command is partially typed followed immediately by a “?” it will display all related commands.

Example:

```
(CLI-config)# ? (The ? will not be display)
targetrssi Set target RSSI level for ATPC
tdm        Display TDM configuration
telnetd    Enable/Disable telnetd
temp       Display IDU and ODU temperature
tftpd      Enable/Disable tftpd
threshold  Set the threshold for the radio parameters
trap       Display snmp trap management information
(CLI-config)#
```



TYPE “?” FOR A LISTING OF ALL CLI COMMANDS.

Changing Password

The debug and view node share the same password. The config node has a separate password. The view and debug mode password is changed in the debug mode. The config node password is changed in the config node. Use the CLI command **passwd** to change the password. The example below demonstrates changing the password for the config node to “control”

Syntax: *passwd <newpassword> <newpassword>*

Example:

```
(CLI-config)# passwd control control (The password must be entered twice)
```

If the command is properly executed, the system will return a “SUCCESS” and return to the **CLI-config** prompt.

If the password is lost and the unit is locked, the pushbutton on the access panel can be used to reset the password and default IP back to the factory settings

Console Port

GigaPlus features a console port which is multiplexed with the port for the 1+1 hot standby operation. If 1+1 hot standby is active the console cable cannot be used. The console port is useful in the event that the unit cannot be accessed via TCP/IP (HTTP or Telnet). A Terminal Emulation program such as **HyperTerminal** or **Putty** can be used to access the radio's CLI via the console port as shown in Figure 12.

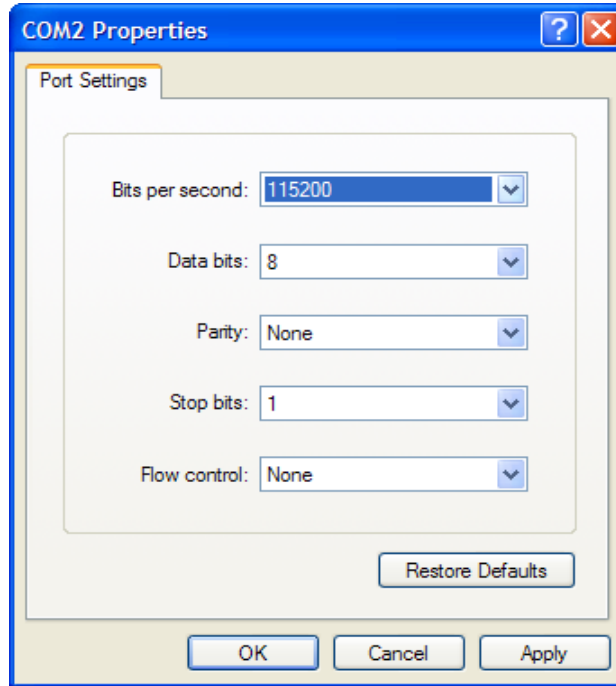

Figure 14 Console Port Setting

Simple Network Management Protocol (SNMP)

TrangoLINK® GigaPlus supports Simple Network Management Protocol (SNMP) for network management. Network management consists of 4 categories:

1. Configuration
2. Accounting
3. Alarm
4. Monitoring/Control

These capabilities allow the network operator to provide superior services through higher network accessibility and integrated accounting system. Use of SNMP requires the customer to have already implemented a NMS or SNMP software package.

The Trango SNMP solution supports MIB-II (system only) and the Trango proprietary Management Information Base (MIB).

Users interested in using the SNMP functionality should review the entire TrangoLINK[®] GigaPlus MIB, found in Appendix D, for a complete understanding of its features.

The following is an overview of some of the more commonly used SNMP objects in the TrangoLINK[®] GigaPlus system. A complete listing can be found in Appendix D.

A copy of the MIB files for the current firmware version can be obtained by contacting Trango Technical Support.

Common Objects for Monitoring and Control

GigE Bandwidth Monitoring

- **gigeEth1InOctets**: Number of octets of payload received on GigE port 1 (copper).
- **gigeEth2InOctets**: Number of octets of payload received on GigE port 2 (copper).
- **gigeEth3InOctets**: Number of octets of payload received on GigE port 3 (SFP).
- **gigeEth4InOctets**: Number of octets of payload received on GigE port 4 (SFP).
- **gigeEth1OutOctets**: Number of octets of payload transmitted on GigE port 1 (copper).
- **gigeEth2OutOctets**: Number of octets of payload transmitted on GigE port 2 (copper).
- **gigeEth3OutOctets**: Number of octets of payload transmitted on GigE port 3 (SFP).
- **gigeEth4OutOctets**: Number of octets of payload transmitted on GigE port 4 (SFP).

RF Monitoring

- **rfInOctet**: Number of octets of payload received from the RF port.
- **rfOutOctet**: Number of octets of payload transmitted to the RF port.
- **rfEthernetInPackets**: Number of octets of payload received from the RF port.
- **rfEthernetOutPackets**: Number of Ethernet payload packets transmitted to the RF port.
- **rfRSSI**: The Receive Signal Strength Indication in dBm the unit receives from the ODU . Commonly referred to as Receive Signal Level (RSL)

Link Status Traps

Various traps are defined as follows:

- **trapReboot:** trap is triggered when the unit is rebooted.
- **trapStartUp:** trap is triggered when the unit boots up.
- **trapBackupLink:** trap triggered when the backup status changes.
- **trapBackupTakeover:** The trap is triggered when the Backup unit has taken over.
- **trapModemLock** - This trap will inform you when there is a change to the link lock.
- **trapDownShift** - This trap will inform you when the modulation of the radio has shifted downed.

Trango recommends monitoring RSSI, MSE, Ethernet Traffic (gigeEthOctets), Temp, and modem lock as a minimum for thorough monitoring of the link. Additional objects and traps can be added to the monitoring software as required. Please review Appendix D MIB for a complete listing of MIB Objects and Traps.

Understanding and familiarization of Simple Network Management Protocol (SNMP) concepts and software platforms are required to utilize SNMP management of the TrangoLINK[®] GigaPlus system.

Due to the large number of programs available for SNMP, Trango does not provide support of SNMP software packages or NMS systems. Some common items to try while having issues monitoring specific OIDs are:

- Properly load the MIBs into your software
- Add a “.0 “ at the end of the OID string

Firmware Upgrade

The firmware on the TrangoLINK GigaPlus can be updated to a newer version through IBM or OBM Ethernet Ports. A firmware release consists of up to two files which contains the appropriate software files that are loaded onto the IDU and ODU:

IDU OS Image Firmware File < idu_GigaPlus_<version>.tar.gz>

ODU Image Firmware File <odu_fw.bin>

If only the IDU firmware was changed then the ODU firmware does not need to be updated.

Before beginning the update procedure, be certain that all required files have been downloaded to an easily accessible directory on your local hard drive.

Upgrade Procedure -TFTP



ALWAYS CONSULT THE UPGRADE INSTRUCTIONS THAT ARE INCLUDED WITH A NEW FIRMWARE RELEASE AS CERTAIN FILES MAY NOT BE REQUIRED FOR AN UPGRADE.

- 1) Place the firmware files in an easily accessible directory path on your computer.
- 2) Telnet into the radio by Clicking on Start menu then RUN. The figures use the default IP address; you must use the correct IP address for the TrangoLINK GigaPlus.

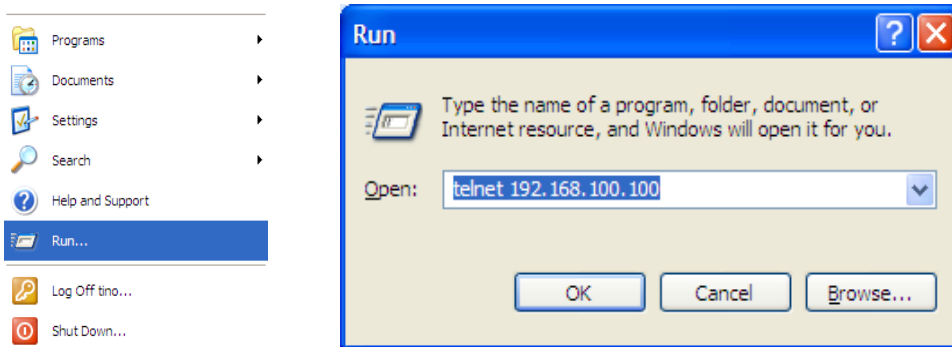

Figure 15 Windows Start & Telnet

- 3) At the login enter your username and password. The username is “*admin*” and default password is “*trango*”
- 4) Enter **config** node by typing “**config**” and entering you write access password. The default config node password is “*trango*”
- 5) Enable the tftp daemon using the **tftpd** command as shown below.

Login as: admin

Password:

Trango System: TrangoLink GigaPLUS Command Line Interface v1.3

(CLI-view)# config

Password:

```
(CLI-config)#  
  
(CLI-config)# tftpd on  
tftpd: on  
SUCCESS  
(CLI-config)#
```

- 6) Open a command prompt (or other CLI interface) window on the PC where the new firmware is being stored and access the directory that you extracted the firmware files.

```
C:\CD Firmware  
C:\Firmware
```

- 7) Using the TFTP command line tool, upload the firmware file. The tftp syntax and an example are below.

```
TFTP [-i] host [GET | PUT] source [destination]
```

```
C:\firmware>tftp -i 192.168.100.100 put idu_gigaplug_v13.tar.gz  
Transfer successful: 1951744 bytes in 15 seconds, 130116 bytes/s
```

- 8) Once the file has been transferred successfully, log back into the unit and apply the updates into the FLASH memory using the ***bootimage upgrade*** command from the config mode. Each firmware needs to be upgraded on the unit using the ***bootimage upgrade*** command.

```
(CLI-config)#  
(CLI-config)# bootimage upgrade idu
```

NOTE: THE BOOTIMAGE UPGRADE COMMAND MUST BE ALLOWED TO COMPLETE BEFORE THE SYSTEM IS REBOOTED. IF THE SYSTEM IS REBOOTED DURING THE WRITING OF THE IMAGE TO FLASH, THE FLASH MAY BECOME CORRUPT – WAIT FOR THE SUCCESS INDICATION BEFORE PROCEEDING.

If the ODU firmware was also being upgraded, the ODU file would be transferred to the GigaPlus ODU using the same method as the IDU file. After loading the file, the ***bootimage upgrade odu*** command would be used to write it to FLASH.

```
(CLI-config)# bootimage upgrade odu
```

- 9) A reboot of the radio is required to load the new image after upgrade

```
(CLI-config)# reboot
```

The upgrade time varies depending upon the images and the size of the image.

The firmware can be verified by logging into the radio via the CLI through the **version** command or Web browser version page under the Firmware Version section.

The Current firmware is the currently running firmware. The firmware which was replaced will be located in the previous images.

Upgrade Procedure -FTP

To perform the firmware upgrade using FTP, use the **ftp** command to load the images into memory, then the **bootimage upgrade** commands just as with the TFTP method. The FTP method is much faster and has built in error checking.

All that is needed is the IP address of the ftp server, a username/password, and the filename to be uploaded. The new file to be uploaded should be placed on the server. The ftp server will prompt for the password before allowing access.

- 1) Put the new software files on the ftp server using the ftp put command from a local computer (these commands are not done from the Trango equipment).

```
ftp> put <source file> <destination>:
```

The <source> will be the filename only. The <destination> will include both path and file name.

- 2) After putting the file onto the server, log into the GigaPlus and run the **ftp** command from the command line as follows to open access to the server:

```
ftp <server_ip> <user_name>
```

```
password: xxxxxxx
```

If prompted for the password multiple times, check the connectivity to the server by pinging the FTP server IP address from the debug prompt.

- 3) Next , get the file from the FTP server by typing the get command from the ftp prompt.

```
ftp> get <file_name>
```

4) Logout of the ftp session

ftp> logout: logout of ftp session.

5) Run the **bootimage** omu and/or **bootimage** odu command as required.

Capacity Upgrades

The GigaPlus speed capacity is standard at 100 Mbps. To upgrade the capacity, an alphanumeric key will be required. This key can be purchased from your Trango sales representative.

To update the capacity key from the Web, copy and paste the key into the Speed License field on the Link Setup Page. Click the submit button. If the license is accepted, the word “Enable” will be displayed as shown below and replace the blank field.

The screenshot displays the GigaPlus web interface for Link Setup. On the left is a navigation menu with categories: Radio Settings (Link Setup, ACM, System, Threshold), Network Settings (IP / IBM, Ethernet, QOS, SNMP), System Status (Version, Link Status, Link Test), System Statistics (Ethernet Stats, TDM Stats, RF Stats), Diagnostics (Diagnostic Options, Loopback Auto, Status Display, System Log), and User Setting (Password, Other). At the bottom of the menu are 'Save Config' and 'Reboot' buttons, and a timestamp: 'Configuration last saved November 30 1999 07:06:30.'

The main content area is divided into four sections:

- System Configuration and Licenses:** Contains 'Datapath: Eth Only' (circled in red), 'Speed License: License 2 enabled', 'TDM License: Enabled', and 'Failover Mode' with radio buttons for 'ON (port on)', 'ON (port off)', and 'OFF'. A 'Submit' button is at the bottom.
- ODU Power:** Shows 'ODU Power: ON' with 'Odupower On' and 'Odupower Off' buttons.
- Link Setup:** Includes 'Default Opmode: ON OFF', 'Tx Freq Min: 21472.00', 'Tx Freq Max: 21786.00', 'Tx Freq: 21472.00', 'Rx Freq: 22704.00', 'Freq Duplex: 1232.00', 'Bandwidth: BW 80', 'Set Modulation: QAM256', and 'Power: 10.00'. A 'Link Setup' button is at the bottom. A note below reads: 'Note: (*) denotes custom profile is in use'.
- Operation Mode:** Shows 'Opmode: ON' with 'Opmode On' and 'Opmode Off' buttons.

Figure 16 Capacity Upgrade in Link Setup Page

The capacity key can also be entered using the *license* command from the command line interface.

5.0 Link Planning

This section describes the process that occurs before installing and setting up an GigaPlus microwave backhaul link

Frequency/Path Planning

Most microwave links use licensed spectrum that requires third party coordination to ensure minimal interference will occur to nearby licensed spectrum users. To ensure success, a path analysis must be done for each link that is being considered. Antenna heights, system gain, rain region and terrain data are evaluated to determine the reliability of the link over time and changing weather.

Trango will run path analysis for its customers using industry standard software, evaluate different equipment options to achieve the customer goals, and assist the coordination process.

Site Selection

After the Planning phase is complete, it is essential that the proposed site be physically evaluated by the operator to ensure that no buildings or vegetation has crossed into the Fresnel zone that would affect operational reliability.

It is not uncommon for tall buildings to be located in what would otherwise be a perfect non blocked line of sight path based on terrain data, but too often this is discovered when the installation is being performed.

The site must also be evaluated for power and shelter provisions.

Licensing

Licensing of spectrum is typically done on an individual path basis. In the US, the FCC will grant licenses for 11 years for paths that do not interfere with other users after the coordination and fees have been paid.

Contact Trango for more information on the above topics.

6.0 Installation

This section describes the installation to ensure that the GigaPlus units are correctly installed. Failure to follow these procedures may result in damage to the equipment and void the factory warranty.

Safety

Installing microwave equipment can be dangerous. Please take the following precautions when installing or performing maintenance on the equipment.

Equipment Protrusions: The equipment has been designed to be free of unnecessary protrusions or sharp surfaces that may catch or otherwise cause injury during handling. However, always take care when working on or around the equipment.

Laser and Fiber Optic Cable Hazards: Trango fiber optic SFP Module transmitters are IEC60825-1 / 21CFR1040-1 Class I compliant and present no danger to personnel in normal use. However: Do not look into active unterminated optical ports or fibers. If visual inspection is required ensure the equipment is turned off or, if a fiber cable, disconnect the far end. Follow the manufacturer's instructions when using an optical test set. Incorrect calibration or control settings could result in hazardous levels of radiation. Protect/cover unconnected optical fiber connectors with dust caps. Place all optical fiber cuttings in a suitable container for safe disposal. Bare fibers and fiber scraps can easily penetrate the skin and eyes.

Lifting Equipment: Be careful when hoisting or lifting the ODU or its antenna during installation or maintenance. The GigaPlus HP ODU is nominally 12 lbs. However, antennas with their mounting hardware can weigh in excess of 100 kg (220 lb) and require specialized lifting equipment and an operator trained and certified in its use.

Protection from RF Burns – Trango ODUs: Trango GigaPlus ODUs do not generate RF fields intense enough to cause RF burns, however, installers/operators should comply with the following cautions:

- 1) It is hazardous to look into or stand in front of an active antenna aperture. Do not stand in front of or look into an antenna without first ensuring the associated transmitter or transmitters are switched off.
- 2) Do not look into the waveguide port of an ODU when the radio is active.

Protection from RF Burns - Tower Site: When the GigaPlus ODU is to be installed where existing antennas are located, avoid exposure to potentially harmful levels of RF radiation from these antennas by:

- 1) Determining the RF exposure risk. If necessary ask the structure/tower owner or operator. When necessary, wear a protective suit or have the transmitter(s) switched off for the duration of the installation.

2) Do not stand in front of or look into any antennas.

Safety Warnings: When a practice or procedure poses implied or potential harm to the user or to the radio equipment, a warning is included in this manual.

Airflow Requirements: Installations must be made so the airflow required for safe and correct operation of Trango equipment is not compromised. For the GigaPlus ODU, unobstructed air passage must be maintained to all sides of the unit. For the GigaPlus IDU, the back of the unit must be kept clear to allow the fan to operate properly.

Circuit Overloading: When connecting the GigaPlus, determine the effect this will have on the power supply, circuit protection devices, and supply wiring. Check GigaPlus power consumption specifications and the supply capability of the power supply system. This check of capacity must extend to the dc power supply and not just to an intermediate connection point.

Power Supply Earthing: -48 V power supply earth must be connected directly to a bonding jumper from an earthing terminal bar or bus.

Electrostatic Discharge (ESD): ESD can damage electronic components. Even if components remain functional, ESD can cause latent damage and/or premature failure. Always wear proper ESD grounding straps when handling or touching any PCB assemblies. Connect your ESD grounding strap to the ground connector on the ODU or IDU units as applicable

Fiber Optic Cables: Handle optical fibers with care. Keep them in a safe and secure location during installation. Do not attempt to bend them beyond their minimum bend radius. Protect/cover unconnected optical fiber connectors with dust caps.

Ground Connections: Reliable grounding of the system must be maintained. Refer to instructions in this manual for grounding of the ODU, ODU cable, lightning surge suppressor, and IDU.

Lightning Surge Suppressor: The GigaPlus IDU to ODU IF cable must be fitted with surge suppressors to prevent damage to equipment. See the installation section for further details.

Mains Power Supply Routing: GigaPlus DC power, T1/E1, Ethernet data and management cables are not to be routed with any AC mains power lines. They are also to be kept away from any power lines which cross them.

Ambient Temperature: The ambient temperature range for the GigaPlus ODU is -40° to +65° Celsius, and -5° to +55° Celsius for the IDU. To ensure operation and to maximize

long term component reliability, ambient temperatures must not be exceeded. Operational specification compliance is not guaranteed for temperatures outside this range.

Mechanical Loading: When installing the GigaPlus ODU and antenna/remote mount on a tower mount or building, ensure the mount is securely anchored first and can support the full load of the radio unit and antenna. Ensure that the additional loading of an GigaPlus ODU will not cause any reduction in the mechanical stability of the mount.

Power Supply Connection: The GigaPlus IDU has the positive pin on its dc power supply connector connected directly to the chassis, which is in turn connected directly to the earth ground through the tower leg. The GigaPlus system must be used with a -48 Vdc power supply which has a positive earth; the power supply earth conductor is the positive supply to the IDU.

- 1) There must be no switching or disconnecting devices in this earth conductor between the dc power supply and the point of connection to a GigaPlus system.
- 2) The power supply must be located in the same premises as the GigaPlus system.
- 3) All wiring which is carrying power to the GigaPlus IDU from the power supply must be larger than 18 AWG and should be twisted to reduce noise into the IDU.

Power Supply Disconnect: An appropriate power supply disconnect device should be provided as part of the building installation.

Rack Mount Temperature Considerations: If the GigaPlus IDU is installed in a closed or multi-unit rack assembly, the operating ambient temperature of the rack environment may be greater than room ambient. The maximum ambient temperature of +55°Celsius applies to the immediate operating environment surrounding the IDU, which if installed in a rack, is the ambient within the rack.

Restricted Access: The GigaPlus system must be installed in restricted access sites. The PoE unit and associated power supply must be installed in restricted areas, such as dedicated equipment rooms, closets, cabinets, or the like. Access to the tower and ODU/antenna location must be restricted.

Note: For USA: In restricted access areas install the GigaPlus system in accordance with articles 110-26 and 110-27 of the **2002 National Electrical Code ANSI/NFPA 70**.

Installation Process

The standard procedure for installing the equipment is as follows:

- 1) Install antenna per antenna installation manual
- 2) Install GigaPlus Power Supply and IDU in rack
- 3) Install ODU on antenna at both ends
- 4) Install IF cabling and surge suppressors
- 5) Align antennas
- 6) Proceed to commissioning.

CAUTION: GigaPlus has no user serviceable parts. Only factory certified personnel should make any changes or repairs to the units.

Preparing for Installation

Tools

The following tools are required for installation:

Adjustable Open Ended Wrench
LMR400 cable
N-Male connector for LMR400
LMR400 stripping tool or razor blade
LMR400 cable crimp tool
#2 Flat screwdriver
#2 Philips Head screwdriver
Stranded 18 AWG wire for power connection
Stranded 12 AWG wire for ODU and IDU ground connections
Wire Insulation strippers for ground and power wire
Terminal crimpers for ground and power wire

Grounding Overview

Grounding of the IF cable should be done at the base of the tower and near the ODU using grounding kits supplied by Trango. In addition, lightning surge suppressors should be used to prevent damage due to nearby lightning strikes. Antenna and ODU should be installed at least 10 feet below the top of the tower to prevent direct lightning strikes.

A Ground wire of AWG 12 or larger should be used and grounded to an Earth grounded tower leg or Bus Bar before entry into the shelter. Figure 16 shows the overall ground design.

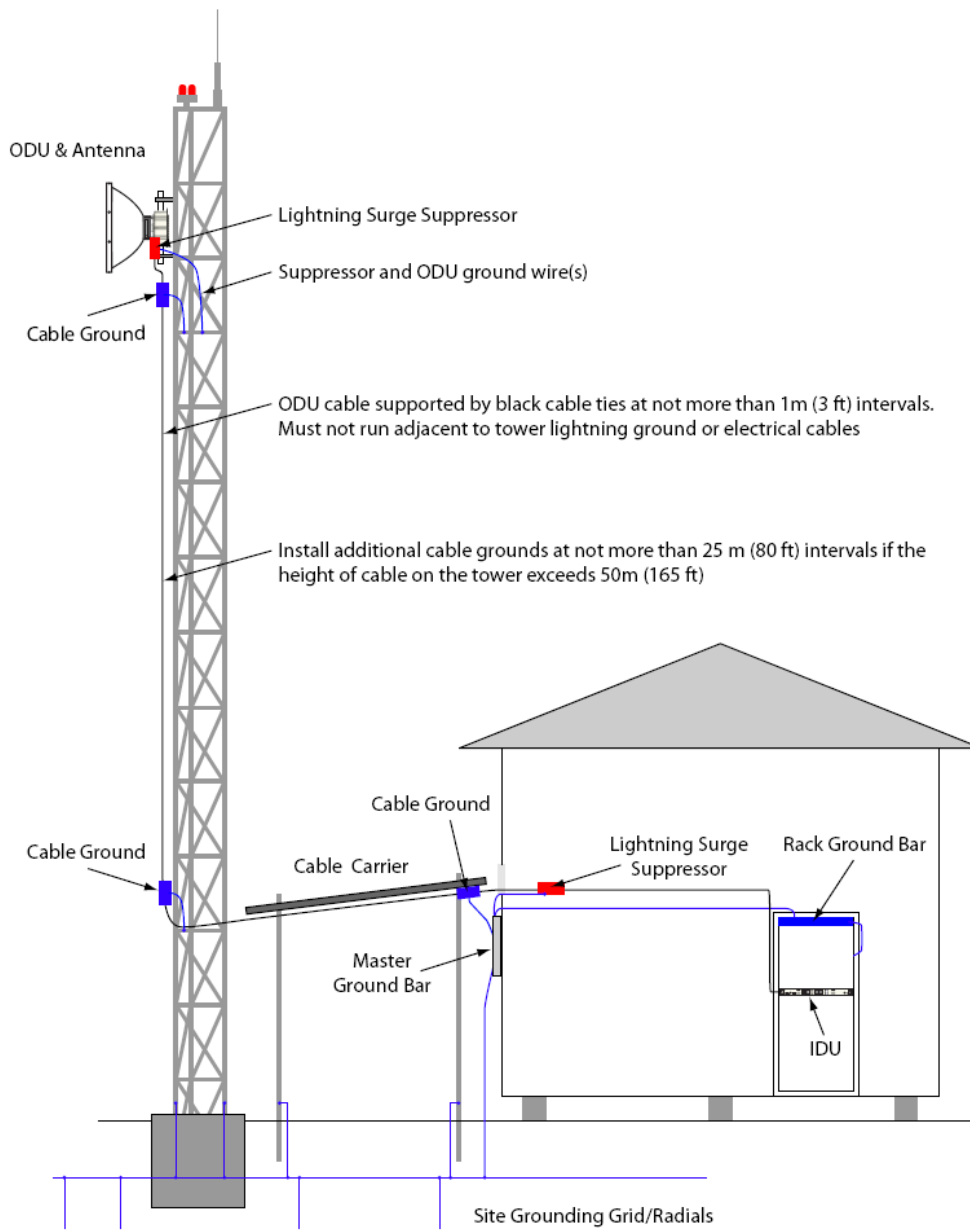

Figure 17 Site Based Grounding Diagram

Power Supply Installation

The GigaPlus requires a -48 Volt power supply to power both the IDU and the ODU. Trango recommends the -48 VDC, 1U rack mount power supply (part# P-SUPPLY-1U-48). This power supply can support up to two GigaPlus IDUs and ODUs and is shown below:



Install the power supply in a temperature controlled shelter or standard 19 inch rack using the holes provided.

NOTE: Ensure that only a -48 Volt Supply is used and that the wiring is correct. If a +48 VDC supply is used and the Earth ground is wired to the negative terminal shown in the figure, permanent damage to the unit may occur.

Antenna Installation

Antennas are typically installed and are coarse aligned using either visually or with third party equipment. Alternatively, some operators prefer to install the radio equipment onto the antenna prior to installing the antenna on the rooftop or tower.

Consult the specific antenna manual for the antenna being used for detailed installation instructions.

The Link Configuration section covers the alignment of the antennas.

Install the IDU

The IDU is supplied with mounting brackets and screws for installation into a standard 19 inch rack. The IDU is provided with a ground lug that should be connected to the rack ground with a short length of stranded copper wire to ensure a low impedance path to ground. When tightening screws follow the recommended torque in the Table below

Screw or Nut Size	Torque (in-lbs)
4-40	6
6-32	12
8-32	22
10-32	37
1/4-20	65

Table 12 Recommended Torque

A single IDU with the Rack Ears installed is shown in the Figure below. It is recommended to always install the IDU on the left side to reduce the length of the grounding wire to the rack.



Figure 18 IDU with Rack Ears installed

Connecting power

The GigaPlus is supplied with a three position locking terminal block for connecting the -48 VDC power supply. The middle position is Earth Ground and the outer two positions are -48 VDC. See the Figure below.



Figure 19 Power Connection on Front Panel

Although only one of the -48 VDC connections is required, dual power supplies can be used to provide redundancy by connection the left position to one supply and the right position to the other supply.

Internal diodes prevent current from flowing the wrong direction in the case that one of the power supplies should fail. Under normal operation the current will be divided between the two supplies.

As mentioned previously, the power supply wires should be twisted to improve the noise rejection of the system.

The wiring used should be two stranded copper wires of a size no smaller than 18 AWG. The wires should be twisted together to reduce susceptibility to noise. At least one turn per inch is recommended. Tighten the two #2 screws to the chassis after installation of the connector to prevent it from pulling out.

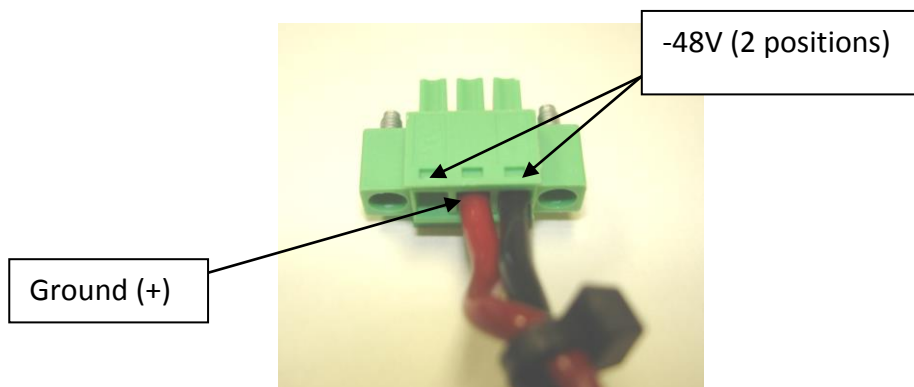

Figure 20 -48 VDC Power Connector Wiring

Ferrite Installation

The IDU ships with a ferrite (Figure 21) to reduce noise entering the unit through the power cable. To install the ferrite, loop the power cable through at least once and close the ferrite. Be sure to install the ferrite as close as possible to the IDU power plug as shown in Figure 22 to improve the noise rejection.

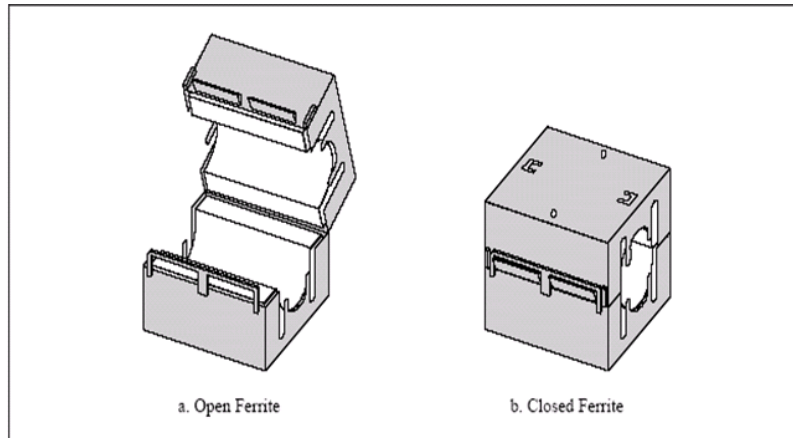

Figure 21 Ferrite



Figure 22 Ferrite Installed

1+1 Hot Standby IDU Installation

The installation of the 1+1 Hot Standby is similar to the 1+0 installation, except the installation is repeated for the second standby unit which is mounted in the rack next to the main unit. The dummy panel is removed in this case.

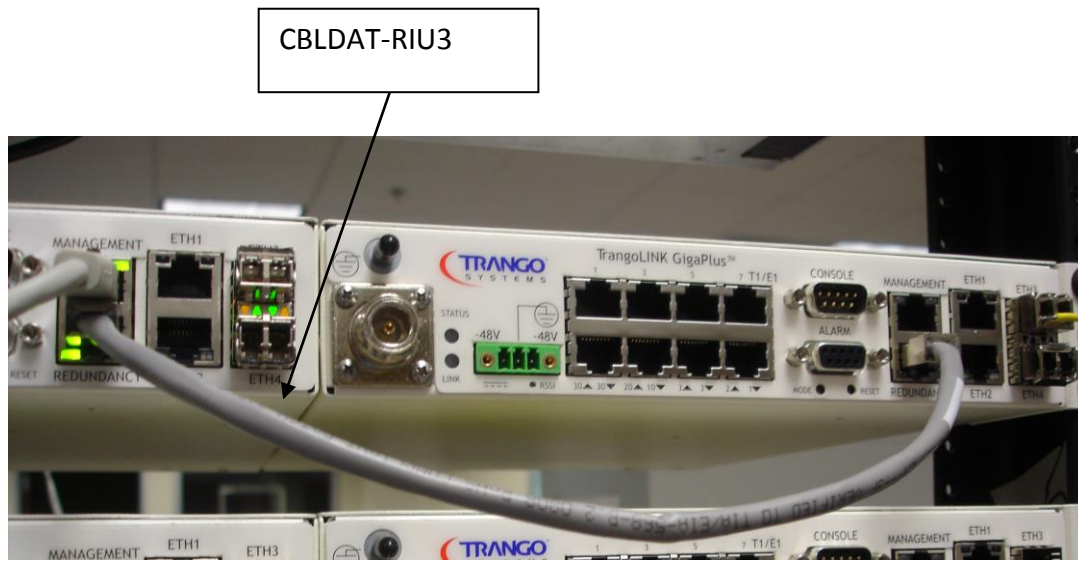

Figure 23 1+1 Hot Standby (IDUs) with CBLDAT-RIU3

HP ODU Installation on Antenna

The ODU portion of the GigaPlus utilizes a slip fit connection that makes installation simple. The ODUs are all designed to mount to a circular waveguide antenna or combiner with the exception of the 6 GHz models.

For 7 to 40 GHz models, simply rotating the ODU will change the antenna polarization being used.

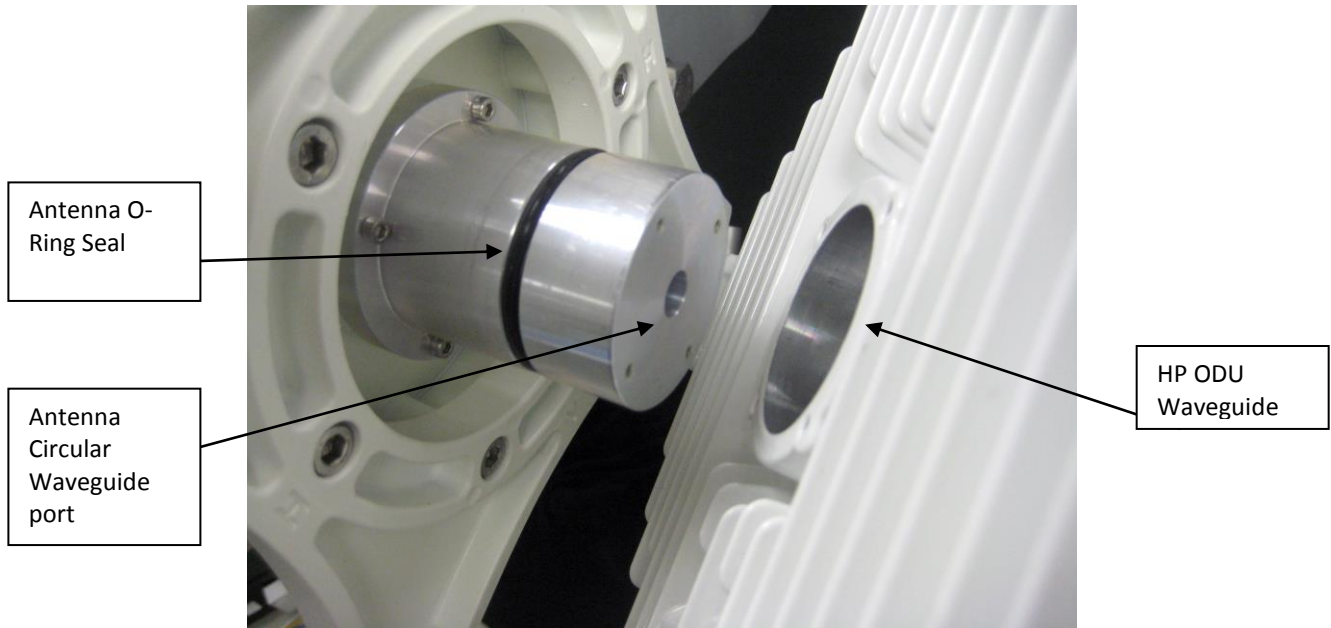

Figure 24 Antenna to HP ODU Slip Fit Waveguide connection

After installing and securing the antenna the HP ODU can be installed directly on the back of the unit. First, determine which Antenna polarization will be used and ensure that the polarization indicator is at the top of the unit.

Polarization Indicators – The letter “V” is die cast on the ODU housing perimeter to assist in mounting the ODU to the antenna in the correct polarization.

For vertical polarization the “V” should be at the top of the unit as shown in the Figure below, and for horizontal polarization the “V” should be at the side of the unit. The IF connector should be positioned towards the lower right for vertical and lower left for horizontal polarization.

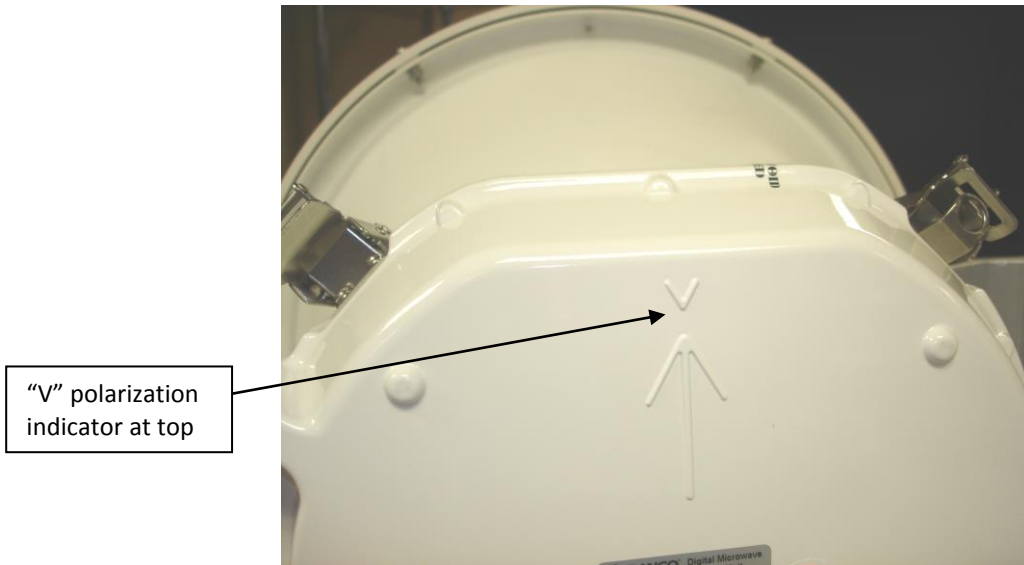

Figure 25 Polarization Indication

Cover the antenna O-ring with silicone grease per the Antenna manual. Failure to do this may result in a damaged O-ring and subsequent damage to or water intrusion into the antenna or ODU.

Gently slide the ODU onto the antenna and clip the four spring loaded latches to the antenna clips as shown below. The latches should be very snug and "click" into place. If there is difficulty closing the latches, then check the waveguide for debris or foreign matter around the perimeter.

Secure the latches that have eyelets with locks if desired.

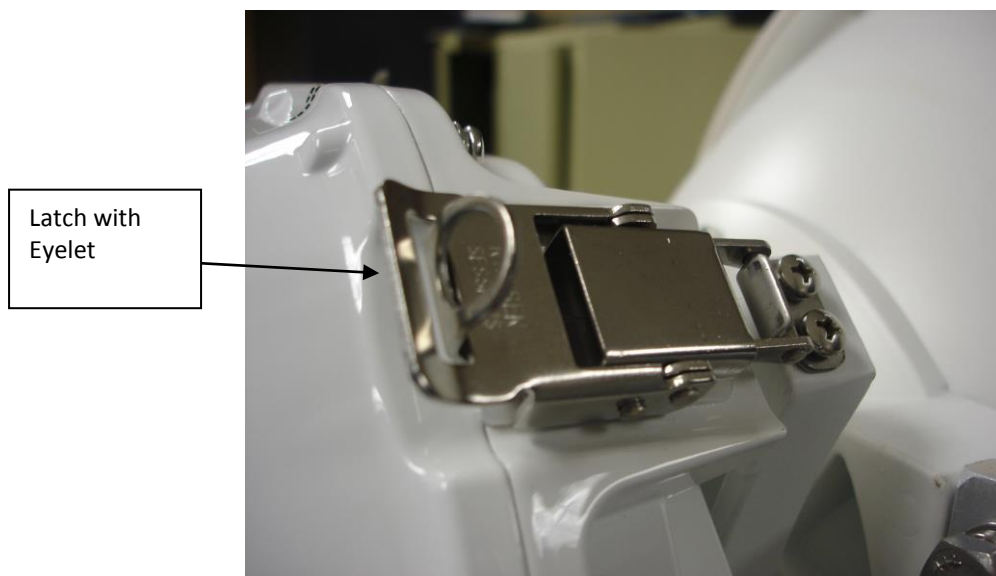

Figure 26 Latch

For HP-06-yyyy-zz and HP-06-yyyy-zz models, both the antennas and radios use a rectangular waveguide opening on the same slip-fit design. The standard polarization is supplied as Vertical. To change the polarization, the antenna must be changed from vertical to horizontal by rotating either the antenna or the antenna waveguide port. Consult the antenna installation manual for more information.

IF Cable Installation

GigaPlus can support up to 1000 foot cable runs between the IDU and ODU.

Lightning Mitigation Recommendations – As shown in the grounding diagram, Trango strongly recommends installing Lightning arrestors at a minimum two points in the IF Cable routing:

- 1) At the closest point of the radio possible
- 2) At the entry point to the building or equipment shelter
- 3) For optimum protection, Trango recommends installing at every 50-75ft

These connections should be secured to the tower or pole at a point where there all paint/plating has been removed to ensure a low impedance path to ground. NOTE: there is no guarantee that use of these arrestors will prevent Lightning damage to the radio or other electronics, but it is prudent system design to aggressively mitigate the effects.

Cable Length Recommendations – Trango recommends that the IF Cable be installed with a 2 ft service loop next to each connector (i.e. below the ODU/ Lightning Arrestor, next to the IDU, etc.) to allow for replacement terminations in the future.

Cable Connectivity – The IF Cable can be connected to the ODU and IDU with right angle N adapters (female towards the cable and male to the IDU/ODU) which prevent the bend radius (minimum 1 inch) from obstructing cabinet doors.

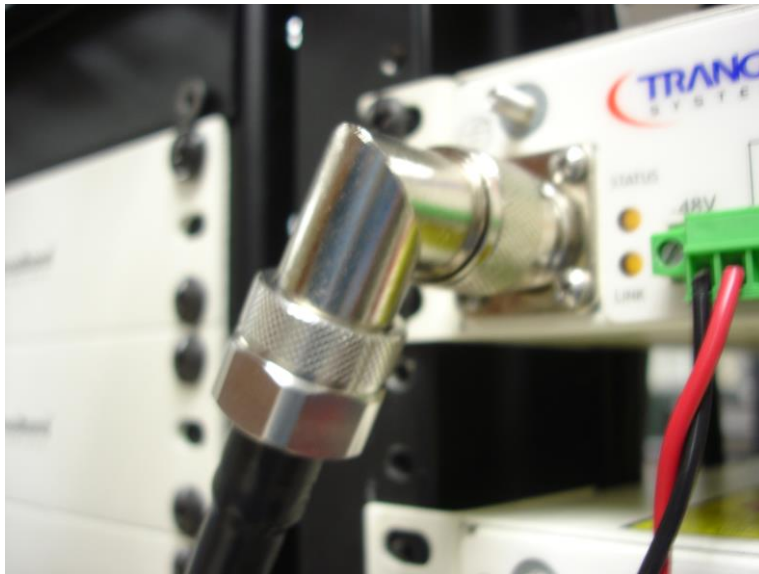

Figure 27 Right Angle N-Connector Mount

Cable Dress Recommendations – Properly securing the IF Cable to the tower or pole structure is important since poorly dressed cables can be abraded by the friction of wind action and cable connection can be degraded over time by the same stresses. When securing the IF Cable to the tower or pole, Trango recommends using tie wraps that are UV resistant (black) to minimize deterioration. Tie wraps should be at least $\frac{1}{4}$ in wide and pulled only as tight as needed to snug the cable to the structure. Narrow tie wraps or over-tightening a tie wrap can compromise the internal structure of the coax and degrade performance. The IF Cable should be secured to the tower or mounting pole at least every 3 to 6 ft with tie wraps or other approved methods. Hanger Assemblies and Cable Clamps are offered by tower companies that can provide an even more rigid attachment for high wind environments.

Cable Terminations - Robust cable and cable connections are CRITICAL to the long-term performance of the link. Any compromise in material, connection precision, or weatherproofing may result in problems that are difficult to fault isolate and only emerge after the link has been exposed to the normal stresses of temperature, rain, and winds.

Cable Type -Trango strongly recommends the use of quality LMR-400 cable and top of the line connectors complimented by well-trained installation personnel following manufacturer’s instructions. Other types of cable may not have adequate shielding and may cause or receive outside interference.

Weather Proofing Cabling

It is important to properly seal each antenna connection to protect against moisture and corrosion. Trango Systems recommends using Coax-Seal which should be applied over the ODU N-Type connector. Coax-Seal is a gum-like tape which is applied by wrapping around the connector and then compressed/molded to form a single cohesive protective covering over the connector.

To properly apply the Coax-Seal product first wrap the connector/case as shown in Figure 28:



Figure 28 Weather Proofing of cable

Secondly, compress the Coax-Seal product to mold into a single protective covering (Figure 29):



Figure 29 Complete weather proofing of cable

1+1 Hot Standby ODU Installation

The installation of the 1+1 Hot Standby ODU is done using a combiner which has two latch mount positions for main and standby ODUs, and the latch and bolt mount for connecting to the antenna. The ODUs may be attached to the combiner first and the combiner bolted and latched to the antenna next as shown below. Two IF cables must be run to each of the two ODUs.

The ODUs must be mounted using the same polarization for 1+1 hot standby operation. For more detail see the manual for the SMC-XX-XX combiner family.



Figure 30 ODUs on SMC combiner (1+1)

7.0 Link Configuration

This section describes the step by step process of configuring a link and making sure it is working properly before installing and putting live traffic on the system.

This section covers basic link establishment for a single link. This setup may be done on the bench or in the field. It is highly recommended that the basic link setup be done on the bench to avoid problems when installing the equipment.

Special bench test setups that provide mounting and fixed or variable attenuation between the RF ports of the units can be obtained from Trango for this purpose. All steps given should be performed on both ends of the link.

IMPORTANT NOTE: If the link was factory preconfigured at Trango before shipment, this section can be skipped since the proper settings are already in place inside the radio units.

Only the IP addresses need to be changed and the Opmode needs to be enabled at both ends.

It is still recommended to set the date and run the *status save* command to record the known good state of the link after installation, alignment and link testing

Web Based Configuration

Web Based 1+0 Setup

The Web interface is the most commonly used way to setup a link. A step by step guide is shown below. To access the Browser interface from the Out-of Band management port, simply connect to the unit using Ethernet cabling, open a web browser and enter the IP address of the radio into the address line. The default IP address is 192.168.100.100

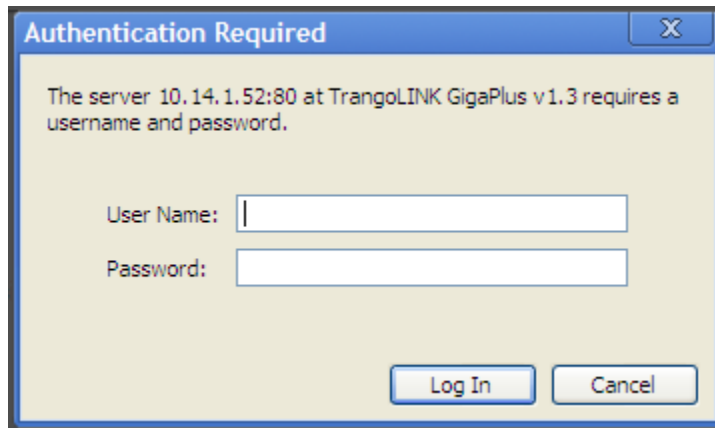

Figure 31 Web Interface Login

Step 1: Enter the username and password

A login window will pop up, requiring the user to enter username and password (See Figure 33). Enter the default user name and password (user: admin, password: trango) and click OK.

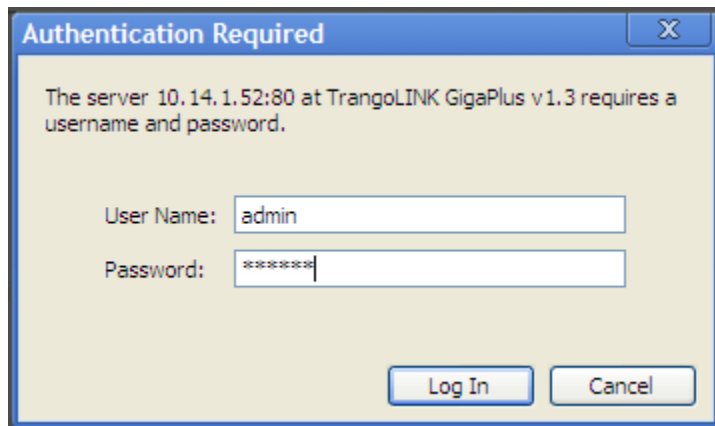

Figure 32 Web Login with Password

Once the user name and password are authenticated, the System Info page (in View mode) will be displayed as shown below:

TRANGO
SYSTEMS

TrangoLINK GigaPlus (10.14.1.21)

Local Active Link: ● RSSI: -57.50 MSE: -33.00 Rx: QAM256
Remote Link: ● RSSI: -56.50 MSE: -34.70 Rx: QAM256

GigaPlus

- Radio Setting
 - Link Setup
 - ACM
 - System
 - Threshold
- Network Settings
 - IP Configuration
 - Ethernet
 - QOS
 - SNMP
- System Status
 - Version**
 - Link Status
 - Link Test
- System Statistics
 - Ethernet Stats
 - TDM Stats
 - RF Stats
- Diagnostics
 - Diagnostic Options
 - Status Display
 - System Log
- User Setting
 - Other

System Info

TrangoLINK GigaPlus

System Description: GigaPlus-3.0.0
System Uptime: (380056) 1:03:20.56
OBM MAC: 00:01:DE:81:6A:60
IBM MAC: 00:01:DE:81:6A:61

Firmware Version

	Current	Previous
IDU FPGA:	0027040B	0027040B
IDU FW:	3p0r0D022412	3p0r0D022412
IDU OS:	2p6r22b0D022412	2p6r22b0D022412
IDU PIC:	62	62
IDU Modem:	1	1
ODU FW:	150410	150410

IDU / ODU Models

	Serial ID	Model
IDU:	8481376	IDU-GigaPlus-1
ODU:	R15100414	HP-23-1232-A

Config Login

Configuration last saved
November 30 1999 07:06:30.

Figure 33 System Information Page (View Mode)

This is the view mode of the web. No changes can be made in this mode. To make changes, the user must log into the config mode using the button highlighted in the figure above. To login, enter user: config, password: trango. This display format will change to that shown below.

TrangoLINK GigaPlus (10.14.1.21)

Local Active Link: ● RSSI: -57.50 MSE: -32.90 Rx: QAM256
 Remote Link: ● RSSI: -57.00 MSE: -34.70 Rx: QAM256

System Info

TrangoLINK GigaPlus

System Description: GigaPlus-3.0.0
 System Uptime: (506319) 1:24:23.19
 OBM MAC: 00:01:DE:81:6A:60
 IBM MAC: 00:01:DE:81:6A:61

Firmware Version

	Current	Previous
IDU FPGA:	0027040B	0027040B
IDU FW:	3p0r0D022412	3p0r0D022412
IDU OS:	2p6r22b0D022412	2p6r22b0D022412
IDU PIC:	62	62
IDU Modem:	1	1
ODU FW:	150410	150410

IDU / ODU Models

	Serial ID	Model
IDU:	8481376	IDU-GigaPlus-1
ODU:	R15100414	HP-23-1232-A

Configuration last saved
November 30 1999 07:06:30.

Figure 34 System Information Page (Config Mode)

Step 2: Set the IP addresses

- a. Click on the Network Settings: IP/IBM configuration page. Set the IP address, Subnet, and Gateway to the address that is desired for the Out-of-band Management Port. Click Submit. At this point the Web session will terminate and the operator must login again using the new IP address.

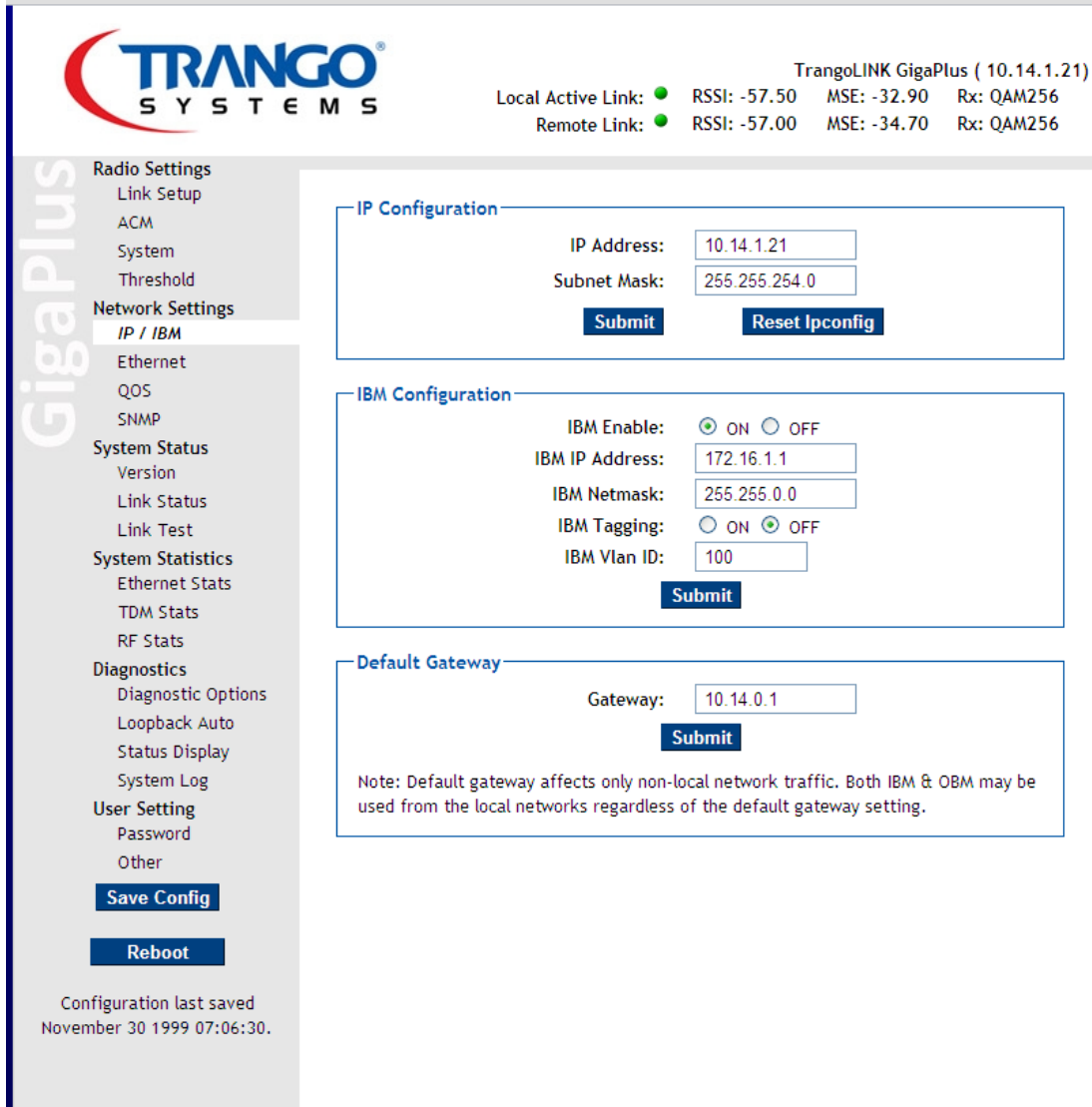

Figure 35 IP Configuration Page

- b. Set the IP address, Subnet, netmask, Tagging (if desired) values, then click the enable. The IBM will now be active and the radio can be managed from the same port as the data input.

Step 3: Set the Radio link parameters

All the parameters should match those submitted and approved by the licensing agency.

- c. Set the Odupower to “On” if it is not already on.
- d. Turn the Opmode to “Off” if it is not already off.

- e. Set the TX frequency, bandwidth, modulation and transmitter power, then click Link Setup. In general, the **Freq Duplex** does not need to be changed unless a non-standard spacing is being used.
- f. After both ends of the link are setup, turn the opmode button “on” to establish the link.

Do not adjust the Failover settings unless 1+1 is desired – See the Section on setting up 1+1 for detail on this.

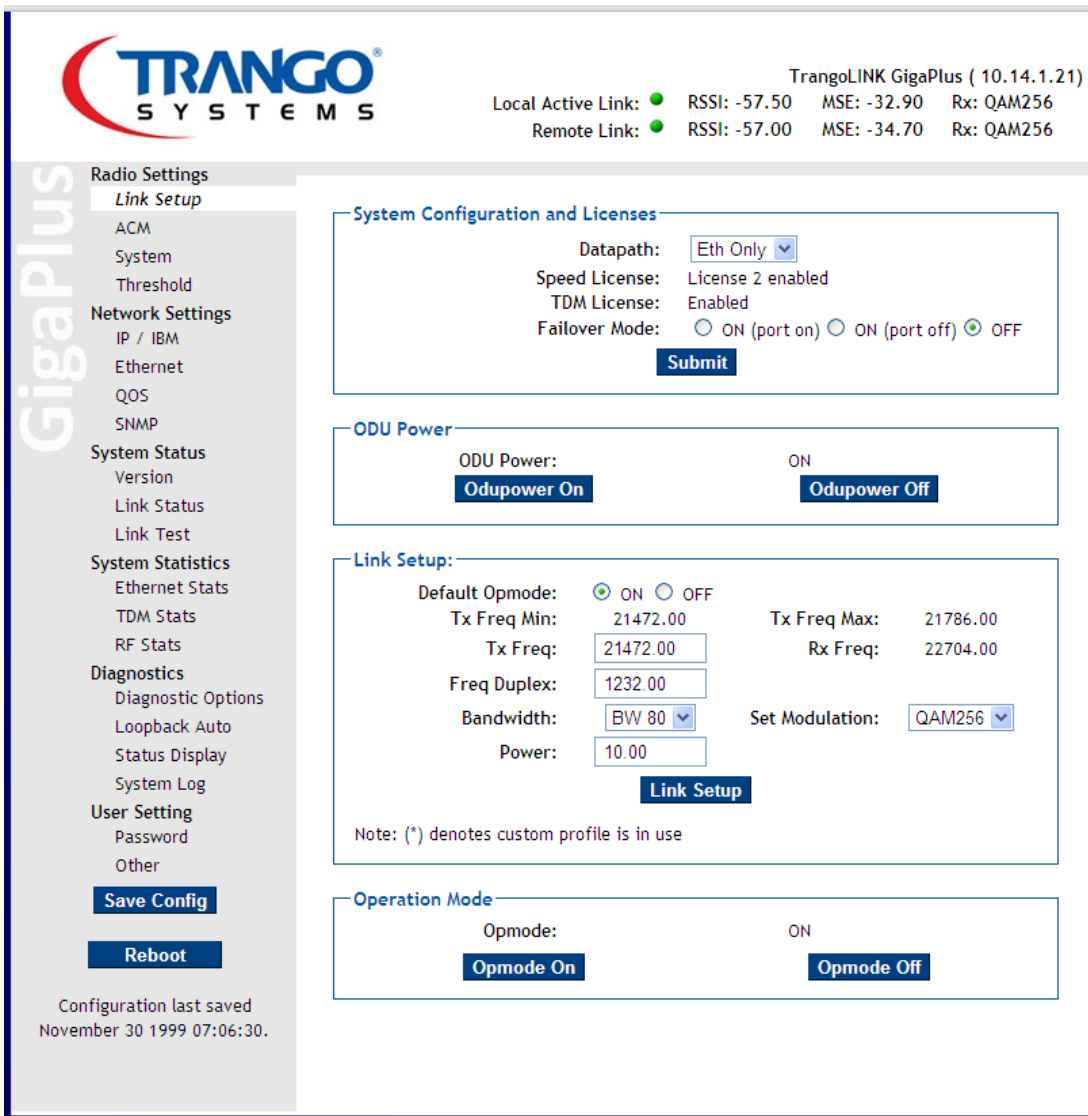

Figure 36 Link Setup Page

The link should now be established between the two sides. The Active Link indicators will turn green and the RSSI and MSE levels will change according to the link distance or attenuation used (bench)

Click the **Config Save** button at the lower left of any webpage – This must be done on both sides of the link.

Web Based 1+1 Setup

The 1+1 Setup is an extension of the basic 1+0 setup. 1+1 hot standby utilizes two GigaPlus units connected to a combiner to allow sharing of an antenna at each end of the link. One of the units at each end is the main (active) unit and the other unit is in standby, which means that it is ready to take over should the active unit fail.

This section assumes that the physical installation has been done already. Return to the Installation section and connect the units in a 1+1 configuration if required.

- 1) Follow the steps for 1+0 on the main link as described above with the backup units turned off.
- 2) Turn the standby radio units on, but ensure the opmode is off on both to avoid disturbing the active link.
- 3) On the Active Link Config Page click the Failover Mode On (port off) button:

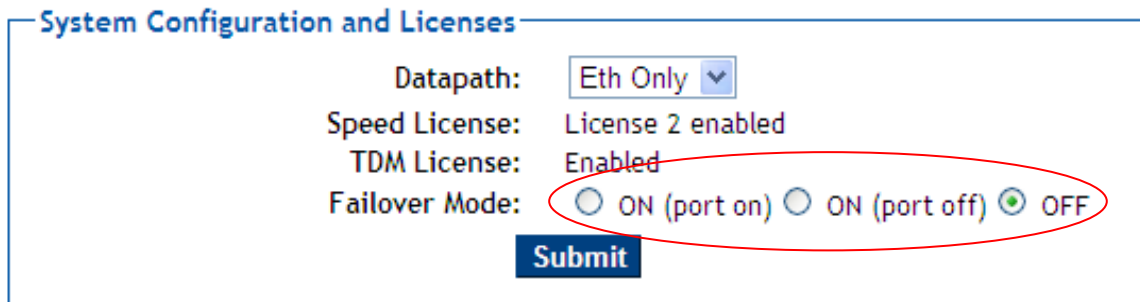

The screenshot shows a configuration page titled "System Configuration and Licenses". It contains several settings: "Datapath:" with a dropdown menu set to "Eth Only"; "Speed License:" with the text "License 2 enabled"; "TDM License:" with the text "Enabled"; and "Failover Mode:" with three radio button options: "ON (port on)", "ON (port off)", and "OFF". The "OFF" option is selected, indicated by a green dot. A red oval highlights the "Failover Mode" section. Below the radio buttons is a blue "Submit" button.

Figure 37 Failover Mode Set

(On with ports on may be used as well, but both the active and standby will have ports on and the standby will receive and forward all traffic out the enabled Ethernet ports. If this method is used, it is imperative to have a network that is capable of detecting and supporting this configuration.)

- 4) Repeat for the Active link other end unit.
- 5) Click the **Config Save** button at the lower left of any webpage – This must be done on both sides of the link. Only the saved configuration will be synced between the active and standby units.
- 6) Wait at least one minute for the election process to complete. The Active unit will not find a standby, so it will continue to be the active.
- 7) Set the same failover mode on the spare radios to become standby units. They will detect the Active units and the Active will sync the config to the standby

units. If failover is enabled on the standby units while the actives are still in the election period, the active role will be taken by the radio with the higher MAC address.

- 8) The display for the Link status at the top of the page should change to show both Active and Standby units “Green” for all 4 units.
- 9) The system is now setup in 1+1 mode. If the main link fails, the ports will be shut down on the main link and the traffic will flow through the standby link, allowing connected switches to re-route the traffic.
- 10) Click the **Config Save** button at the lower left of any webpage – This must be done on both sides of the link.

Adaptive Coding and Modulation (ACM) (Optional)

Enabling ACM permits configuration of the MSE Improve and Degrade thresholds. It is recommended to use the default values for best performance. Select the “On” button and then click on the submit button to make the change if ACM is desired.

The screenshot displays the TrangoLINK GigaPlus web interface. At the top left is the Trango Systems logo. The top right shows the system name 'TrangoLINK GigaPlus (10.14.1.21)' and link status: 'Local Active Link: RSSI: -57.50 MSE: -32.60 Rx: QAM256' and 'Remote Link: RSSI: -57.00 MSE: -34.59 Rx: QAM256'. A sidebar on the left lists navigation options: Radio Settings (Link Setup, ACM, System, Threshold), Network Settings (IP / IBM, Ethernet, QOS, SNMP), System Status (Version, Link Status, Link Test), System Statistics (Ethernet Stats, TDM Stats, RF Stats), Diagnostics (Diagnostic Options, Loopback Auto, Status Display, System Log), and User Setting (Password, Other). Below the sidebar are 'Save Config' and 'Reboot' buttons, and a message: 'Configuration last saved November 30 1999 07:06:30.' The main content area is titled 'Adaptive Modulation (ACM):' and contains a table for configuring MSE Improve and MSE Degrade thresholds for various modulation schemes. The 'ACM enable' option is set to 'ON'. A 'Submit' button is located at the bottom of the configuration table.

Modulation	ACM enable:	MSE Improve	MSE Degrade
QPSK	<input checked="" type="radio"/> ON <input type="radio"/> OFF	N/A	-17.10
QAM16		-25.30	-18.50
QAM32		-26.30	-21.30
QAM64		-29.20	-24.30
QAM128		-32.10	-27.20
QAM256		-32.10	N/A

Figure 38 ACM Setup

Automatic Transmit Power Control (ATPC) (Optional)

Enable ATPC to maintain the receive signal level at a constant level (target RSSI) during rain fading. ATPC is typically used for very short range links that require the input level into the radio unit to be reduced to avoid saturating the receiver. Enabling ATPC results in a transmit power level on both sides of the link that is lower than the maximum level for the set modulation. If set power would normally be the maximum level and the receiver will not be over driven, it is recommended to leave ATPC off since it will never be exercised.

Alarms, RPS and Telnet/TFTP Daemons

The System page also allows the individual alarms on the front panel to be enabled and disabled from the web – these can be used to turn various other devices on and off as long as the current and voltage limits of the relays are not exceeded . The telnet and tftp daemons can also be turned on and off from the web to control access to the system. The Rapid Port Shutdown can be enabled or disabled here as well to allow for routing protocols to reroute traffic if the link should go down.

TRANGO SYSTEMS

TrangoLINK GigaPlus (10.14.1.21)

Local Active Link: ● RSSI: -57.50 MSE: -32.70 Rx: QAM256
 Remote Link: ● RSSI: -57.00 MSE: -34.59 Rx: QAM256

GigaPlus

- Radio Settings
 - Link Setup
 - ACM
- System**
 - Threshold
- Network Settings
 - IP / IBM
 - Ethernet
 - QOS
 - SNMP
- System Status
 - Version
 - Link Status
 - Link Test
- System Statistics
 - Ethernet Stats
 - TDM Stats
 - RF Stats
- Diagnostics
 - Diagnostic Options
 - Loopback Auto
 - Status Display
 - System Log
- User Setting
 - Password
 - Other

ATPC Setting

ATPC: ON OFF

ATPC Step Size:

ATPC Max Power:

Target RSSI:

Submit

Custom Profile

Custom Profile: No custom profile in use

Custom Add/Remove: Add Remove

Submit

System Setting

Alarm 1: ON OFF Alarm 2: ON OFF

Telnetd: ON OFF Tftpd: ON OFF

RPS: ON OFF Smart Mode: ON OFF

Submit

Status Snapshot

Status Save

Status last saved at: November 30 1999 07:08:25.

Save Config

Reboot

Configuration last saved
November 30 1999 07:06:30.

Figure 39 ATPC Setup/ RPS /Telnetd/ tftpd/alarms



TrangoLINK GigaPlus (10.14.1.21)

Local Active Link: ● RSSI: -57.50 MSE: -32.70 Rx: QAM256
 Remote Link: ● RSSI: -57.00 MSE: -34.70 Rx: QAM256

GigaPlus

- Radio Settings
 - Link Setup
 - ACM
 - System
 - Threshold
- Network Settings
 - IP / IBM
 - Ethernet
 - QOS
 - SNMP
- System Status
 - Version
 - Link Status
 - Link Test
- System Statistics
 - Ethernet Stats
 - TDM Stats
 - RF Stats
- Diagnostics
 - Diagnostic Options
 - Loopback Auto
 - Status Display
 - System Log
- User Setting
 - Password
 - Other

Save Config

Reboot

Configuration last saved
November 30 1999 07:06:30.

Threshold Info:

Parameter	Min	Max	0	1	2	3	5
RSSI:	<input type="text" value="-85.00"/>	<input type="text" value="-20.00"/>	<input type="checkbox"/>	<input checked="" type="checkbox"/>	<input type="checkbox"/>	<input type="checkbox"/>	<input type="checkbox"/>
MSE:	<input type="text" value="-45.00"/>	<input type="text" value="-15.00"/>	<input checked="" type="checkbox"/>	<input type="checkbox"/>	<input type="checkbox"/>	<input type="checkbox"/>	<input type="checkbox"/>
BER:	<input type="text" value="0.00"/>	<input type="text" value="0.00"/>	<input checked="" type="checkbox"/>	<input type="checkbox"/>	<input type="checkbox"/>	<input type="checkbox"/>	<input type="checkbox"/>
FER:	<input type="text" value="0.00"/>	<input type="text" value="0.00"/>	<input checked="" type="checkbox"/>	<input type="checkbox"/>	<input type="checkbox"/>	<input type="checkbox"/>	<input type="checkbox"/>
IDU Temp:	<input type="text" value="-10"/>	<input type="text" value="55"/>	<input checked="" type="checkbox"/>	<input type="checkbox"/>	<input type="checkbox"/>	<input type="checkbox"/>	<input type="checkbox"/>
ODU Temp:	<input type="text" value="-40"/>	<input type="text" value="58"/>	<input checked="" type="checkbox"/>	<input type="checkbox"/>	<input type="checkbox"/>	<input type="checkbox"/>	<input type="checkbox"/>
In Port Util:	<input type="text" value="0"/>	<input type="text" value="100"/>	<input checked="" type="checkbox"/>	<input type="checkbox"/>	<input type="checkbox"/>	<input type="checkbox"/>	<input type="checkbox"/>
Out Port Util:	<input type="text" value="0"/>	<input type="text" value="100"/>	<input checked="" type="checkbox"/>	<input type="checkbox"/>	<input type="checkbox"/>	<input type="checkbox"/>	<input type="checkbox"/>
Link Down:	N/A	N/A	<input checked="" type="checkbox"/>	<input type="checkbox"/>	<input type="checkbox"/>	<input type="checkbox"/>	<input type="checkbox"/>

Submit

Threshold Actions: 0=None, 1=alarm 1, 2=alarm 2, 3=snmptrap, 4=switchover, 5=rps

Switchover and rps are mutually exclusive where Switchover applies only 1+1 configuration and RPS only applies to 1+0 configuration

Figure 40 Threshold Setup Page

Ethernet Configuration

The Ethernet page allows the individual Ethernet traffic ports on the front panel to be enabled, disabled, and configured from the web – The two main traffic ports GE1 and GE2 can be configured for 10/100/100BaseT operation. If the AutoNego is set to “disable”, the Autosensing function is also disabled and the matching settings must be made on the router or switch. Otherwise the link between the device and the IDU via the Ethernet cable for the specific Ethernet port will be lost.

The Priority setting allows assigning priority for all untagged traffic on that port from 0 to 7 (7 being highest, 0 the lowest). If a previously tagged packet arrives, the priority field in the VLAN tag COS field will take precedence over the port priority. All untagged traffic will be given the port priority.

Ingress rate limiting allows the operator to restrict the traffic on any one port to a maximum rate, which allows some bandwidth shaping for each port.

The SFP ports, GE3 and GE4 are fixed at 1000Base T but can accommodate single and multimode fiber modules as well as copper.

The screenshot displays the TrangoLINK GigaPlus configuration interface. At the top left is the Trango Systems logo. The top right shows the device name 'TrangoLINK GigaPlus (10.14.1.21)' and link status: 'Local Active Link: ● RSSI: -57.50 MSE: -32.80 Rx: QAM256' and 'Remote Link: ● RSSI: -57.00 MSE: -34.70 Rx: QAM256'. A vertical sidebar on the left lists navigation options: Radio Settings (Link Setup, ACM, System, Threshold), Network Settings (IP / IBM), Ethernet (QOS, SNMP), System Status (Version, Link Status, Link Test), System Statistics (Ethernet Stats, TDM Stats, RF Stats), Diagnostics (Diagnostic Options, Loopback Auto, Status Display, System Log), and User Setting (Password, Other). Below the sidebar are 'Save Config' and 'Reboot' buttons, and a note: 'Configuration last saved November 30 1999 07:06:30.' The main content area is titled 'GigaPlus' and contains three sections: 'Egress Margin' with a value of 10 and a 'Submit' button; 'Ethernet Port Settings' for GE1 and GE2, with GE1 settings (Status: ON, Enable: Enable, Auto Nego: Enable, Duplex: Full, Speed: 1000, Priority: 0, Max rate: 1000) and GE2 settings (Status: OFF, Enable: Enable, Auto Nego: Enable, Duplex: Full, Speed: 1000, Priority: 0, Max rate: 1000); and 'SFP Port Settings' for GE3 and GE4, with GE3 settings (Status: OFF, Enable: Enable, Auto Nego: ON, Duplex: Full, Speed: 1000, Priority: 0, Ingress rate: 1000) and GE4 settings (Status: OFF, Enable: Enable, Auto Nego: ON, Duplex: Full, Speed: 1000, Priority: 0, Ingress rate: 1000). Each section has a 'Submit' button.

Figure 41 Ethernet Setup Page

Quality of Service Setup

The QoS page allows the QoS setup for all incoming traffic. Two modes are selectable- Either Strict or Weighted Round Robin (WRR). Strict will ensure that all higher priority queues are emptied before sending any packets from lower priority queues.

The incoming priority levels can be mapped to the queues in the Ethernet QoS Settings box. For WRR Mode, the Diffserv tag in the incoming IP packets can be used to map the packet to a priority, and then to a queue .

TRANGO SYSTEMS

TrangoLINK GigaPlus (10.14.1.21)

Local Active Link: ● RSSI: -57.50 MSE: -32.80 Rx: QAM256
 Remote Link: ● RSSI: -57.00 MSE: -34.70 Rx: QAM256

QOS Mode

QOS Mode:

Ethernet QOS Settings

	Pri 0	Pri 1	Pri 2	Pri 3	Pri 4	Pri 5	Pri 6	Pri 7
Queue#:	<input type="text" value="0"/>	<input type="text" value="1"/>	<input type="text" value="2"/>	<input type="text" value="3"/>	<input type="text" value="4"/>	<input type="text" value="5"/>	<input type="text" value="6"/>	<input type="text" value="7"/>

Save Config

Reboot

Configuration last saved
November 30 1999 07:06:30.

Figure 42 QoS Setup Page for Strict mode

DCSP Value Mapping

The QoS page with WRR mode selected will reveal all the DSCP values and drop down boxes to select which priority they should be mapped to. This is done for each Ethernet port individually by selecting the ETH1 to ETH4 tab in the box. For convenience, common class identifiers are shown along with the corresponding DSCP value below:

AF11 maps to dscp **10** (001010)
AF12 maps to dscp **12** (001100)
AF13 maps to dscp **14** (001110)
AF21 maps to dscp **18** (010010)
AF22 maps to dscp **20** (010100)
AF23 maps to dscp **22** (010110)
AF31 maps to dscp **26** (011010)
AF32 maps to dscp **28** (011100)
AF33 maps to dscp **30** (011110)
AF41 maps to dscp **34**(100010)
AF42 maps to dscp **36** (100100)
AF43 maps to dscp **38** (100110)
CS1(precedence 1) maps to dscp **8** (001000)
CS2(precedence 2) maps to dscp **16** (010000)
CS3(precedence 3) maps to dscp **24** (011000)
CS4(precedence 4) maps to dscp **32** (100000)
CS5(precedence 5) maps to dscp **40** (101000)
CS6(precedence 6) maps to dscp **48** (110000)
CS7(precedence 7) maps to dscp **56** (111000)
EF maps to dscp **46** (101110)

Default settings for priority of DSCP are all 0, so the user must change the priority for each Code Point according to the desired Priority.



TrangoLINK GigaPlus (10.14.1.21)

Local Active Link: ● RSSI: -57.50 MSE: -32.80 Rx: QAM256

Remote Link: ● RSSI: -57.00 MSE: -34.59 Rx: QAM256

GigaPlus

- Radio Settings
 - Link Setup
 - ACM
 - System
 - Threshold
- Network Settings
 - IP / IBM
 - Ethernet
 - QOS**
 - SNMP
- System Status
 - Version
 - Link Status
 - Link Test
- System Statistics
 - Ethernet Stats
 - TDM Stats
 - RF Stats
- Diagnostics
 - Diagnostic Options
 - Loopback Auto
 - Status Display
 - System Log
- User Setting
 - Password
 - Other

Save Config

Reboot

Configuration last saved
November 30 1999 07:06:30.

QOS Mode

QOS Mode: WRR

Submit

Ethernet QOS Settings

	Pri 0	Pri 1	Pri 2	Pri 3	Pri 4	Pri 5	Pri 6	Pri 7
Queue#:	<input style="width: 30px;" type="text" value="0"/>	<input style="width: 30px;" type="text" value="1"/>	<input style="width: 30px;" type="text" value="2"/>	<input style="width: 30px;" type="text" value="3"/>	<input style="width: 30px;" type="text" value="4"/>	<input style="width: 30px;" type="text" value="5"/>	<input style="width: 30px;" type="text" value="6"/>	<input style="width: 30px;" type="text" value="7"/>
Weight:	<input style="width: 30px;" type="text" value="1"/>	<input style="width: 30px;" type="text" value="2"/>	<input style="width: 30px;" type="text" value="3"/>	<input style="width: 30px;" type="text" value="4"/>	<input style="width: 30px;" type="text" value="5"/>	<input style="width: 30px;" type="text" value="6"/>	<input style="width: 30px;" type="text" value="7"/>	<input style="width: 30px;" type="text" value="8"/>

Submit

DSCP/Priority Settings

Eth1 | Eth2 | Eth3 | Eth4

DSCP	Pri	DSCP	Pri	DSCP	Pri	DSCP	Pri	DSCP	Pri	DSCP	Pri
1	<input style="width: 20px;" type="text" value="0"/>	2	<input style="width: 20px;" type="text" value="0"/>	3	<input style="width: 20px;" type="text" value="0"/>	4	<input style="width: 20px;" type="text" value="0"/>	5	<input style="width: 20px;" type="text" value="0"/>	6	<input style="width: 20px;" type="text" value="0"/>
7	<input style="width: 20px;" type="text" value="0"/>	8	<input style="width: 20px;" type="text" value="0"/>	9	<input style="width: 20px;" type="text" value="0"/>	10	<input style="width: 20px;" type="text" value="0"/>	11	<input style="width: 20px;" type="text" value="0"/>	12	<input style="width: 20px;" type="text" value="0"/>
13	<input style="width: 20px;" type="text" value="0"/>	14	<input style="width: 20px;" type="text" value="0"/>	15	<input style="width: 20px;" type="text" value="0"/>	16	<input style="width: 20px;" type="text" value="0"/>	17	<input style="width: 20px;" type="text" value="0"/>	18	<input style="width: 20px;" type="text" value="0"/>
19	<input style="width: 20px;" type="text" value="0"/>	20	<input style="width: 20px;" type="text" value="0"/>	21	<input style="width: 20px;" type="text" value="0"/>	22	<input style="width: 20px;" type="text" value="0"/>	23	<input style="width: 20px;" type="text" value="0"/>	24	<input style="width: 20px;" type="text" value="0"/>
25	<input style="width: 20px;" type="text" value="0"/>	26	<input style="width: 20px;" type="text" value="0"/>	27	<input style="width: 20px;" type="text" value="0"/>	28	<input style="width: 20px;" type="text" value="0"/>	29	<input style="width: 20px;" type="text" value="0"/>	30	<input style="width: 20px;" type="text" value="0"/>
31	<input style="width: 20px;" type="text" value="0"/>	32	<input style="width: 20px;" type="text" value="0"/>	33	<input style="width: 20px;" type="text" value="0"/>	34	<input style="width: 20px;" type="text" value="0"/>	35	<input style="width: 20px;" type="text" value="0"/>	36	<input style="width: 20px;" type="text" value="0"/>
37	<input style="width: 20px;" type="text" value="0"/>	38	<input style="width: 20px;" type="text" value="0"/>	39	<input style="width: 20px;" type="text" value="0"/>	40	<input style="width: 20px;" type="text" value="0"/>	41	<input style="width: 20px;" type="text" value="0"/>	42	<input style="width: 20px;" type="text" value="0"/>
43	<input style="width: 20px;" type="text" value="0"/>	44	<input style="width: 20px;" type="text" value="0"/>	45	<input style="width: 20px;" type="text" value="0"/>	46	<input style="width: 20px;" type="text" value="0"/>	47	<input style="width: 20px;" type="text" value="0"/>	48	<input style="width: 20px;" type="text" value="0"/>
49	<input style="width: 20px;" type="text" value="0"/>	50	<input style="width: 20px;" type="text" value="0"/>	51	<input style="width: 20px;" type="text" value="0"/>	52	<input style="width: 20px;" type="text" value="0"/>	53	<input style="width: 20px;" type="text" value="0"/>	54	<input style="width: 20px;" type="text" value="0"/>
55	<input style="width: 20px;" type="text" value="0"/>	56	<input style="width: 20px;" type="text" value="0"/>	57	<input style="width: 20px;" type="text" value="0"/>	58	<input style="width: 20px;" type="text" value="0"/>	59	<input style="width: 20px;" type="text" value="0"/>	60	<input style="width: 20px;" type="text" value="0"/>
61	<input style="width: 20px;" type="text" value="0"/>	62	<input style="width: 20px;" type="text" value="0"/>	63	<input style="width: 20px;" type="text" value="0"/>						

Submit

Figure 43 Qos Setup Page for WRR Mode

The screenshot displays the TrangoLINK GigaPlus web interface. At the top left is the Trango Systems logo. The top right shows the device name 'TrangoLINK GigaPlus (10.14.1.21)' and link status: 'Local Active Link: RSSI: -57.50 MSE: -32.90 Rx: QAM256' and 'Remote Link: RSSI: -57.00 MSE: -34.70 Rx: QAM256'. A left sidebar contains a menu with categories: Radio Settings (Link Setup, ACM, System, Threshold), Network Settings (IP / IBM, Ethernet, QOS), SNMP, System Status (Version, Link Status, Link Test), System Statistics (Ethernet Stats, TDM Stats, RF Stats), Diagnostics (Diagnostic Options, Loopback Auto, Status Display, System Log), and User Setting (Password, Other). Below the menu are 'Save Config' and 'Reboot' buttons, and a note: 'Configuration last saved November 30 1999 07:06:30.' The main content area has two sections: 'SNMP Management' with fields for 'SNMP read-string: public', 'SNMP write-string: private', and 'SNMP trap-string: trapstr', and a 'Submit' button; and 'SNMP Trap Configuration' with a table for enabling traps for five managers, each with an 'IP Address' field set to '0.0.0.0' and a 'Submit' button.

Radio Settings
 Link Setup
 ACM
 System
 Threshold

Network Settings
 IP / IBM
 Ethernet
 QOS

SNMP

System Status
 Version
 Link Status
 Link Test

System Statistics
 Ethernet Stats
 TDM Stats
 RF Stats

Diagnostics
 Diagnostic Options
 Loopback Auto
 Status Display
 System Log

User Setting
 Password
 Other

Save Config

Reboot

Configuration last saved
 November 30 1999 07:06:30.

SNMP Management

SNMP Daemon: ON OFF
 SNMP read-string:
 SNMP write-string:
 SNMP trap-string:
Submit

SNMP Trap Configuration

	Enable	IP Address
SNMP Manager 1 IP:	<input type="radio"/> ON <input checked="" type="radio"/> OFF	<input type="text" value="0.0.0.0"/>
SNMP Manager 2 IP:	<input type="radio"/> ON <input checked="" type="radio"/> OFF	<input type="text" value="0.0.0.0"/>
SNMP Manager 3 IP:	<input type="radio"/> ON <input checked="" type="radio"/> OFF	<input type="text" value="0.0.0.0"/>
SNMP Manager 4 IP:	<input type="radio"/> ON <input checked="" type="radio"/> OFF	<input type="text" value="0.0.0.0"/>
SNMP Manager 5 IP:	<input type="radio"/> ON <input checked="" type="radio"/> OFF	<input type="text" value="0.0.0.0"/>

Submit

Figure 44 SNMP Setup Page

Status Monitoring Overview

The Web interface provides many ways to look at the status of the traffic flowing across the link and the health of the link. The following Figures show the various counters that can be monitored.

Link Status

This page displays the Radio and System Status. The System contains information on the Alarms, IDU temperature, and fan status. The Radio status displays RSSI, Mean Square Error (MSE), Bit Error Rate (BER), Frame Error Rate (FER) and ODU temperatures. The temperatures are the temperature in Celcius inside the ODU and IDU units and will always be higher than the outside air temp by 15-20 degrees.

This page also displays the connection status on the modem, T1/E1, and Ethernet ports.

The Ethernet and T1/E1 Port Status indicators will only turn green when the T1/E1 port is connected with a valid signal format.

All the link status indicators should be green when working properly. Red usually indicates that an ODU is off or not connected. A grey status indicator represents an indicator that does not apply for the model of ODU being used.

TRANGO SYSTEMS

TrangoLINK GigaPlus (10.14.1.21)

Local Active Link: ● RSSI: -57.50 MSE: -32.90 Rx: QAM256
 Remote Link: ● RSSI: -57.00 MSE: -34.59 Rx: QAM256

GigaPlus

- Radio Settings
 - Link Setup
 - ACM
 - System
 - Threshold
- Network Settings
 - IP / IBM
 - Ethernet
 - QOS
 - SNMP
- System Status
 - Version
 - Link Status**
 - Link Test
- System Statistics
 - Ethernet Stats
 - TDM Stats
 - RF Stats
- Diagnostics
 - Diagnostic Options
 - Loopback Auto
 - Status Display
 - System Log
- User Setting
 - Password
 - Other

Save Config

Reboot

Configuration last saved
November 30 1999 07:06:30.

System Status

RSSI:	-57.50	MSE:	-32.90
BER:	3.74E-09	FER:	1.87E-05
Alarm1:	ON	Alarm2:	OFF
IDU Temp:	34	ODU Temp:	42
Fan Control:	Fan On	1+1 Sync:	Not synchronized

Modem and ODU Link Status

Link:	●	ODU IF PII:	●
Timing:	●	ODU Tx PII:	●
Preamble:	●	ODU Rx PII:	●
LDPC:	●	IDU PII:	●

Ethernet Port Status

GE1:	●	GE2:	●	GE3:	●	GE4:	●
------	---	------	---	------	---	------	---

T1/E1 Port Status

Port 1:	●	Port 3:	●	Port 5:	●	Port 7:	●
Port 2:	●	Port 4:	●	Port 6:	●	Port 8:	●

Figure 45 Link Status Page

- Radio Settings
 - Link Setup
 - ACM
 - System
 - Threshold
- Network Settings
 - IP / IBM
 - Ethernet
 - QOS
 - SNMP
- System Status
 - Version
 - Link Status
 - Link Test**
- System Statistics
 - Ethernet Stats
 - TDM Stats
 - RF Stats
- Diagnostics
 - Diagnostic Options
 - Loopback Auto
 - Status Display
 - System Log
- User Setting
 - Password
 - Other
- Save Config**
- Reboot**

Configuration last saved
November 30 1999 07:06:30.

Linktest Display

Linktest: number of cycles (1-99) **Submit**

	LINK	RSSI	MSE	Tx	Rx
1>	1	-57.50	-32.90	QAM256	QAM256
2>	1	-57.50	-32.80	QAM256	QAM256
3>	1	-57.50	-32.90	QAM256	QAM256
4>	1	-57.50	-32.80	QAM256	QAM256
5>	1	-57.50	-32.90	QAM256	QAM256

Show Result
Clear Screen

Figure 46 Link Test Page

Ethernet Statistics

Contains statistical information on individual front panel Ethernet ports. These statistics are used to determine the error rate of traffic and the traffic flow. It should be noted that port utilization stats are given as a percentage of the Ethernet line rate (not the radio link capacity).

IN: Means traffic been received from the device (Switch / Router) attached to the particular GigE port.

OUT: Means traffic sent from the IDU to the device attached to the particular GigE port

TrangoLINK GigaPlus (10.14.1.21)

Local Active Link: ● RSSI: -57.50 MSE: -32.80 Rx: QAM256
 Remote Link: ● RSSI: -57.00 MSE: -34.59 Rx: QAM256

Ethernet Counters

	GE1	GE2	GE3	GE4
Enable:	ON	ON	ON	ON
Status:	ON	OFF	OFF	OFF
Pause Frame:	OFF	OFF	OFF	OFF
Auto Negotiate:	ON	ON	ON	ON
Duplex:	Full	Full	Full	Full
Priority:	0	0	0	0
Speed:	1000	1000	1000	1000
Max Rate:	1000	1000	1000	1000
In Octets:	3337440644	0	0	0
In Ucast Pkts:	72932557	0	0	0
In Nucast Pkts:	0	0	0	0
In Port Rate:	387	0	0	0
In Port Util:	38	0	0	0
Out Octets:	2449272172	0	0	0
Out Ucast Pkts:	75176826	0	0	0
Out Nucast Pkts:	0	0	0	0
Out Port Rate:	345	0	0	0
Out Port Util:	34	0	0	0
Collision:	0	0	0	0
CRC Errors:	0	0	0	0

[Clear Counters](#)

Figure 47 Ethernet Statistics Page

T1/E1 Statistics

Contains industry standard statistical information on each T1/E1 interface, updated every 20 seconds. The information on this page only applies when the datapath is set to Eth+T1 or Eth +E1.

TRANGO SYSTEMS

TrangoLINK GigaPlus (10.14.1.21)

Local Active Link: ● RSSI: -57.50 MSE: -32.80 Rx: QAM256
 Remote Link: ● RSSI: -57.00 MSE: -34.59 Rx: QAM256

GigaPlus

- Radio Settings
 - Link Setup
 - ACM
 - System
 - Threshold
- Network Settings
 - IP / IBM
 - Ethernet
 - QOS
 - SNMP
- System Status
 - Version
 - Link Status
 - Link Test
- System Statistics
 - Ethernet Stats
 - TDM Stats**
 - RF Stats
- Diagnostics
 - Diagnostic Options
 - Loopback Auto
 - Status Display
 - System Log
- User Setting
 - Password
 - Other

Save Config

Reboot

Configuration last saved
November 30 1999 07:06:30.

T1/E1 Events and Error Counters

	Status	LOF	(blue) AIS	(yellow) RAI
TDM1:	●	●	●	●
TDM2:	●	●	●	●
TDM3:	●	●	●	●
TDM4:	●	●	●	●
TDM5:	●	●	●	●
TDM6:	●	●	●	●
TDM7:	●	●	●	●
TDM8:	●	●	●	●

	CRC	ex-CRC	FEBE	LCV
TDM1:	0	0	0	0
TDM2:	0	0	0	0
TDM3:	0	0	0	0
TDM4:	0	0	0	0
TDM5:	0	0	0	0
TDM6:	0	0	0	0
TDM7:	0	0	0	0
TDM8:	0	0	0	0

Clear Counters

Figure 48 TDM (T1/E1) Statistics Page

RF Statistics

Contains summary statistical information on the RF in and RF out interfaces. RF out shows statistics for the total packets (including T1/E1 and ACM frames) transmitted to the far end of the link. RF in shows the same information for packets received from the far end. *Total Drop packets* represents the cumulative dropped Ethernet frames

The *Port rate* is updated every 20 seconds. The *Port Util* is a percentage of the total available radio capacity being used and is also updated at 20 second intervals.

TRANGO SYSTEMS

TrangoLINK GigaPlus (10.14.1.21)
Local Active Link: ● RSSI: -57.50 MSE: -32.80 Rx: QAM256
Remote Link: ● RSSI: -57.00 MSE: -34.70 Rx: QAM256

GigaPlus

- Radio Settings
 - Link Setup
 - ACM
 - System
 - Threshold
- Network Settings
 - IP / IBM
 - Ethernet
 - QOS
 - SNMP
- System Status
 - Version
 - Link Status
 - Link Test
- System Statistics
 - Ethernet Stats
 - TDM Stats
- RF Stats**
- Diagnostics
 - Diagnostic Options
 - Loopback Auto
 - Status Display
 - System Log
- User Setting
 - Password
 - Other

Save Config

Reboot

Configuration last saved
November 30 1999 07:06:30.

RF Counters

	RF IN	RF OUT
Total Octets:	1868153521	312208844
Total Pkts:	76663315	72716523
Total Drop Pkts:	3	N/A
Port Rate(Mbps):	358	365
Port Util(%):	98	100

Clear Counters

Figure 49 RF Statistics Page

Diagnostic Options

IDU LED allows setting the LEDs under the TDM ports to indicate the TDM port status or represent the RSSI level read from the ODU.

Loopback Mode is used for troubleshooting and will enable the traffic to be looped back either at the IDU IF section just before the ODU connector, or at the digital level inside the modem. This feature is very useful for fault isolation during setup.

Syslog level is used to set the detail of the entries made to the system log. The log level can be adjusted via the CLI or web. Syslog levels are as follows:

- **Set** is used to identify any changes made by the user, such as changing the frequency, turning opmode off, etc.
- **Event** is used to log any events that are triggered by the system, such as an ACM shift down or up or a trap generated upon high traffic utilization.
- **Stat** is used to identify link statistics on a periodic basis. It is recommended that this level only be used for debugging since the entire syslog memory (about 1500 entries) will be used up quickly and older events may be overwritten.

System Reboot in: is used to reboot the IDU and ODU after a set amount of time for troubleshooting purposes. This is useful for troubleshooting where changes to the remote end may cause the link to drop. If this command is executed, the system will automatically reboot itself and load the stored settings, restoring the system to a known configuration. One common use of this feature is to turn the far end transmitter off to listen on the local end for interference. By using this command the far end will automatically reload and start transmitting again after the specified time.

Diagnostic Export generates a diagnostic.bin file. To download this file, the TFTP function of the IDU must be enabled. Then from the PC's command prompt, execute the following command: `tftp -i [IP address of the IDU] get diagnostic_Gigaplus.bin` The file will have to be submitted to Trango Product Support for processing.

Config Reset will reset all saved system configuration settings **EXCEPT IP addresses and license keys** to the factory defaults. Frequency, power, speed, etc. will all be reset and need to be re-entered. Reboot is required after executing the config reset command.

Config Export will export the current configuration to the file export_config.txt. This is useful for saving a known working configuration and quickly bringing another IDU/ODU up with the same configuration using the **Config Import** command.

Config Import allows the previously exported config file to be saved into the IDU non-volatile memory. The file must first be uploaded to the IDU. Reboot is required.

Config Execute executes the config file just imported. The config should be saved after the verification of proper operation.

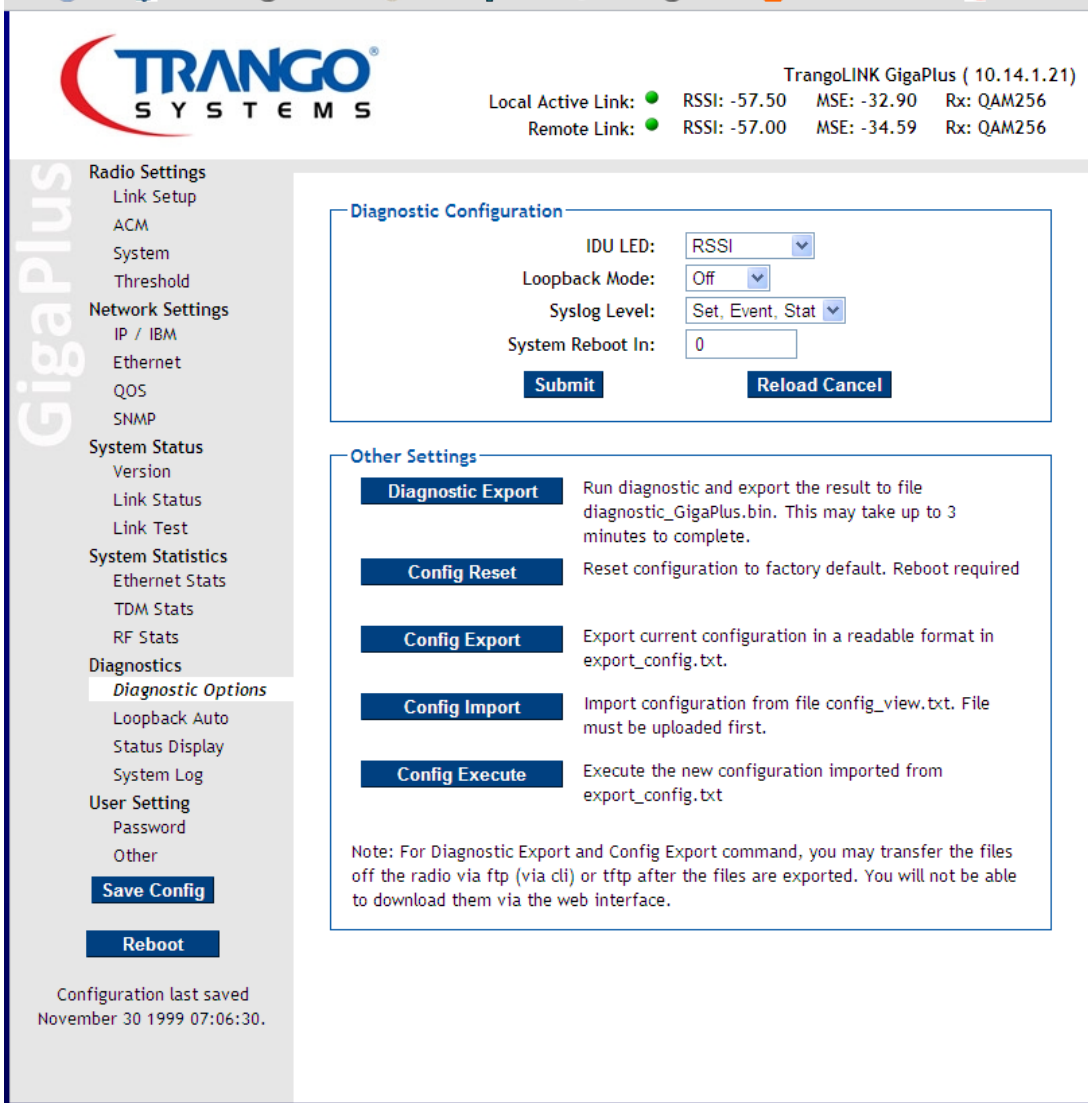

Figure 50 Diagnostic Options

Loopback Auto runs a Linktest in the digital and IF loopback modes automatically so that the link restores upon completion. This is very useful for running diagnostics on the far end of a link where communication will be lost during the test. The Link **will be broken** during the test so ensure that a maintenance window is planned. For a single iteration the link will be down for up to 10 seconds.



Figure 51 Loopback Auto Page

Status Display shows several useful items to help diagnose link problems:

- Config View – Displays the current configuration settings stored in memory
- Status Compare - Upon initial establishment of the link, the Status Save button in the System section should be depressed, saving the current link status into memory. At any time in the future, the Status Compare drop down menu can be selected and executed to see a direct comparison between the current link status and the originally saved status.
- Siglevel – This command will display details about the actual TX and RX signal levels, signal quality, and ODU communication stats.

TRANGO SYSTEMS

TrangoLINK GigaPlus (10.14.1.21)

Local Active Link: ● RSSI: -57.50 MSE: -32.90 Rx: QAM256
 Remote Link: ● RSSI: -57.00 MSE: -34.59 Rx: QAM256

GigaPlus

- Radio Settings
 - Link Setup
 - ACM
 - System
 - Threshold
- Network Settings
 - IP / IBM
 - Ethernet
 - QOS
 - SNMP
- System Status
 - Version
 - Link Status
 - Link Test
- System Statistics
 - Ethernet Stats
 - TDM Stats
 - RF Stats
- Diagnostics
 - Diagnostic Options
 - Loopback Auto
 - Status Display**
 - System Log
- User Setting
 - Password
 - Other

Save Config

Reboot

Configuration last saved
November 30 1999 07:06:30.

Status Display

Display Options: Choose a Option... **Submit** **Screen Clear**

- Choose a Option...
- Config View
- Status Compare
- Siglevel

Figure 52 Status Display Page

TrangoLINK GigaPlus (10.14.1.21)

Local Active Link: ● RSSI: -57.50 MSE: -32.80 Rx: QAM256

Remote Link: ● RSSI: -57.00 MSE: -34.59 Rx: QAM256

GigaPlus

Radio Settings

- Link Setup
- ACM
- System
- Threshold

Network Settings

- IP / IBM
- Ethernet
- QOS
- SNMP

System Status

- Version
- Link Status
- Link Test

System Statistics

- Ethernet Stats
- TDM Stats
- RF Stats

Diagnostics

- Diagnostic Options
- Loopback Auto
- Status Display**
- System Log

User Setting

- Password
- Other

[Save Config](#)

[Reboot](#)

Configuration last saved
November 30 1999 07:06:30.

Status Display

Display Options: Choose a Option... [Submit](#) [Screen Clear](#)

FIC Version:	62	62
Modem Version:	1	1
ODU FW Version:	150410	150410
Tx Freq:	21472.00	21472.00
Rx Freq:	22704.00	22704.00
Freq Duplex:	1232.00	1232.00
Tx Power:	10.00	10.00
Modulation:	256QAM	256QAM
Bandwidth:	80.00	80.00
Datapath:	Eth Only	Eth Only
ACM Enable:	enabled	enabled
Alignment Mode:	Off	Off
ATPC:	Off	Off
ATPC Step Size:	1	1
ATPC Max Power:	17.0	17.0
ODU Power:	On	On
Speed Modulation:	256QAM	256QAM
Speed Bandwidth:	80.00	80.00
Default Opmode:	On	On
Loopback Mode:	off	off
Data Pattern:	fpga	fpga
ODU LED:	On	On
Target RSSI:	-40.00	-40.00
IDU Led:	RSSI	RSSI
Fan Control:	On	On
Failover:	Off	Off
Httpd:	On	On
RFS:	Off	Off
Tftpd:	Off	Off
Telnetd:	On	On

Figure 53 Status Compare Result Page

System Log

The system log records events, errors, and statistics with time stamps attached.

The Syslog Export process is similar to the Diagnostic Export process (See **Diagnostic Export** above). The name of the file to download is syslog.txt

TRANGO SYSTEMS

TrangoLINK GigaPlus (10.14.1.21)

Local Active Link: ● RSSI: -57.50 MSE: -32.90 Rx: QAM256
 Remote Link: ● RSSI: -57.00 MSE: -34.59 Rx: QAM256

GigaPlus

- Radio Settings
 - Link Setup
 - ACM
 - System
 - Threshold
- Network Settings
 - IP / IBM
 - Ethernet
 - QOS
 - SNMP
- System Status
 - Version
 - Link Status
 - Link Test
- System Statistics
 - Ethernet Stats
 - TDM Stats
 - RF Stats
- Diagnostics
 - Diagnostic Options
 - Loopback Auto
 - Status Display
- System Log
- User Setting
 - Password
 - Other

Save Config

Reboot

Configuration last saved
November 30 1999 07:06:30.

Syslog Display

```

80> 0:01:39:26.790 [2] [STAT] RF IN (358 Mbps, util=98), RF
OUT (365 Mbps, util=100)
81> 0:01:39:56.930 [2] [STAT] RSSI=-57, MSE=-32, BER=3.23E-
09, ODU_TEMP=42, IDU_TEMP=35
82> 0:01:39:56.930 [2] [STAT] RF IN (5 Mbps, util=1), RF
OUT (6 Mbps, util=1)
83> 0:01:40:09.280 [1] [EVENT] System status save
84> 0:01:40:20.990 [2] [STAT] RSSI=-57, MSE=-32, BER=3.21E-
09, ODU_TEMP=42, IDU_TEMP=35
85> 0:01:40:20.990 [2] [STAT] RF IN (358 Mbps, util=98), RF
OUT (365 Mbps, util=100)
86> 0:01:40:45.520 [2] [STAT] RSSI=-57, MSE=-32, BER=3.18E-
09, ODU_TEMP=42, IDU_TEMP=35
87> 0:01:40:45.520 [2] [STAT] RF IN (358 Mbps, util=98), RF
OUT (365 Mbps, util=100)
88> 0:01:41:02.860 [1] [EVENT] System status save
89> 0:01:41:09.780 [2] [STAT] RSSI=-57, MSE=-32, BER=3.15E-
09, ODU_TEMP=42, IDU_TEMP=35
90> 0:01:41:09.780 [2] [STAT] RF IN (0 Mbps, util=0), RF
OUT (0 Mbps, util=0)
91> 0:01:41:33.950 [2] [STAT] RSSI=-57, MSE=-32, BER=3.13E-
09, ODU_TEMP=42, IDU_TEMP=35
92> 0:01:41:33.950 [2] [STAT] RF IN (365 Mbps, util=100),
RF OUT (365 Mbps, util=100)
93> 0:01:41:57.970 [2] [STAT] RSSI=-57, MSE=-32, BER=3.11E-
09, ODU_TEMP=42, IDU_TEMP=35
94> 0:01:41:57.970 [2] [STAT] RF IN (358 Mbps, util=98), RF
OUT (365 Mbps, util=100)
Success.
  
```

Syslog Export **Syslog Clear**

Figure 54 System Log

Config View

Config View allows complete display of the current system configuration. By selecting the “config View” option from the pull down menu, then “submit, the display will be shown. The window is scrollable and expandable on most browsers.

TRANGO SYSTEMS

TrangoLINK GigaPlus (10.14.1.21)

Local Active Link: ● RSSI: -57.50 MSE: -32.90 Rx: QAM256
 Remote Link: ● RSSI: -57.00 MSE: -34.59 Rx: QAM256

GigaPlus

- Radio Settings
 - Link Setup
 - ACM
 - System
 - Threshold
- Network Settings
 - IP / IBM
 - Ethernet
 - QOS
 - SNMP
- System Status
 - Version
 - Link Status
 - Link Test
- System Statistics
 - Ethernet Stats
 - TDM Stats
 - RF Stats
- Diagnostics
 - Diagnostic Options
 - Loopback Auto
 - Status Display**
 - System Log
- User Setting
 - Password
 - Other

Save Config

Reboot

Configuration last saved
November 30 1999 07:06:30.

Status Display

Display Options:

Data Path: ETH Only

```

***** Radio Setting *****
Tx Frequency:      21472.00
Rx Frequency:     22704.00
Tx Power:         10.00
Speed Modulation: QAM256
Speed Bandwidth:  50
ODUPower:         On
Default Opmode:   On
ODU LED:          On
ACM:              On
ATPC Enable:      Off
ATPC Step Size:   1
ATPC Max Power:   17.00
Target RSSI:      -40.00
Alignment Mode:   Off
Loopback Mode:    Off
Data Pattern:     External
RPS:              Off

***** ACM Setting *****
QPSK Improve:     -20.30
QAM16 Improve:    -25.30
QAM32 Improve:    -26.30
QAM64 Improve:    -29.20
QAM128 Improve:   -32.10
QAM256 Improve:   -32.10
QPSK Degrade:     -17.10
QAM16 Degrade:    -18.50

```

Figure 55 Config View

Password Settings

Allows individually setting the view and config level access passwords for the web (HTTP) interface.

TRANGO
SYSTEMS

TrangoLINK GigaPlus (10.14.1.21)
Local Active Link: ● RSSI: -57.50 MSE: -32.90 Rx: QAM256
Remote Link: ● RSSI: -57.00 MSE: -34.59 Rx: QAM256

GigaPlus

- Radio Settings
 - Link Setup
 - ACM
 - System
 - Threshold
- Network Settings
 - IP / IBM
 - Ethernet
 - QOS
 - SNMP
- System Status
 - Version
 - Link Status
 - Link Test
- System Statistics
 - Ethernet Stats
 - TDM Stats
 - RF Stats
- Diagnostics
 - Diagnostic Options
 - Loopback Auto
 - Status Display
 - System Log
- User Setting
 - Password**
 - Other

Save Config

Reboot

Configuration last saved
November 30 1999 07:06:30.

Change Web Login Password

Old Password:
New Password:
Confirm Password:
Change

Change Config Login Password

Old Config Password:
New Config Password:
Confirm Password:
Change

Figure 56 Password Settings

Other Settings

Allows setting the system remark for the IDU which is displayed at the top of every web page, as well as changing the web refresh rate. Setting the web refresh rate to 0 will stop the automatic web refreshing, and the reload button on the browser must be used to update the fields on the web page.

The screenshot displays the TrangoLINK GigaPlus web interface. At the top left is the Trango Systems logo. The top right shows the device name 'TrangoLINK GigaPlus (10.14.1.21)' and two link status indicators: 'Local Active Link' and 'Remote Link', both with green status lights and associated RSSI, MSE, and Rx values.

A vertical sidebar on the left contains a menu with the following items: Radio Settings (Link Setup, ACM, System, Threshold), Network Settings (IP / IBM, Ethernet, QOS, SNMP), System Status (Version, Link Status, Link Test), System Statistics (Ethernet Stats, TDM Stats, RF Stats), Diagnostics (Diagnostic Options, Loopback Auto, Status Display, System Log), and User Setting (Password). Below the menu are buttons for 'Other', 'Save Config', and 'Reboot'. At the bottom of the sidebar, it states 'Configuration last saved November 30 1999 07:06:30.'

The main content area has two sections:

- Web Refresh Rate:** A form with a label 'Rate in seconds:' and an input field containing '30'. A 'Submit' button is below the input. A note below the form reads: 'Note: Setting refresh rate to '0' will disable the refreshing of the webpage'.
- System Remark:** A form with a label 'System Remark:' and an input field containing 'TrangoLINK GigaPlus'. A 'Submit' button is below the input.

Figure 57 Other Settings

Command Line Interface (CLI) Based Configuration

CLI Based 1+0 Configuration

This section covers all the basics that are normally required for setting up the link using either the telnet, SSH, or serial COM port to access the units. Step by step instructions with session examples are given. The CLI interface has more functions available than the Web Interface. Simply type the “?” to see a list of available commands.

Step 1: Connect to Each Unit via one of the CLI interfaces

In all the examples given, telnet was used, but the login procedure is similar for each. To log into each units using the default IP address of 192.168.100.100.

Use the windows telnet program or any other telnet client program. When prompted for the Login enter **admin** and for password, enter **trango**. The Trango Systems command line interface application should respond as follows:

```
Microsoft windows XP [Version 5.1.2600]
(C) Copyright 1985-2001 Microsoft Corp.

C:\Documents and Settings\user>telnet 192.168.100.100

CLI login: admin
Password:

Trango System: TrangoLINK GigaPlus Command Line Interface v1.3.0
```

When logging into the radio unit, the operator always enters the (CLI-view)# node, from which only status of the system can be seen. To make changes to system settings, the operator must enter the (CLI-config)# node of to allow changes to the system to be made. Type the command **config** and the password **trango**. The password can be changed later.

```
(CLI-view)# config
Password:
```

Step 2: Change the Out of Band (OBM) Management IP Address

It is recommended to change the IP address on both ends of the radio first, before installing the link to ensure that no problems will be encountered accessing the units in the field from the destination network subnet

To change the IP address of the system, first check the ip settings using the **ip** command.

```
(CLI-config)# ipconfig
IP Address:          192.168.100.100
Subnet Mask:        255.255.255.0
Gateway IP:         192.168.100.1
ETH1 MAC:           00:01:de:81:65:44
ETH2 MAC:           00:01:de:81:65:45
```

Next, change the IP address and subnet mask. The system will not be responsive after the change. Reconnect to the GigaPlus using the new IP address.

```
(CLI-config)# ipconfig ip 10.14.1.41 255.255.254.0
IP Address:          10.14.1.41
Netmask:            255.255.254.0

SUCCESS
```

After re-connecting, change the gateway address as necessary.

```
(CLI-config)# ipconfig gateway 10.14.0.1
Gateway IP:         10.14.0.1

SUCCESS
```

Confirm that the changes are made:

```
(CLI-config)# ip
(CLI-config)# ipconfig
IP Address:          10.14.1.41
```

Subnet Mask:	255.255.254.0
Gateway IP:	10.14.0.1
ETH1 MAC:	00:01:de:81:65:44
ETH2 MAC:	00:01:de:81:65:45

Step 3: Turn the ODU Section of the radio on

Type **odupower on** to apply power to the Radio section of the unit. After the CLI returns the status of “**on**”, enter **model** to show the models, serial numbers, TR spacing and transmit frequency range of the unit.

```
(CLI-config)# odupower on
ODU Power enable:      on
```

SUCCESS

```
(CLI-config)# model
IDU Model:             IDU-GigaPlus-1
IDU Serial ID:         8480068
ODU Model:             HP2-23-1200-3A
ODU Serial ID:         C110301327
TX Freq Min:           22000.00
TX Freq Max:           22400.00
Freq Duplex:           1200.00 (MHz)
```

Step 4: Set the Transmitter and Receiver Center frequency

The center frequency must be within the min and max shown in the model command and must be at least ½ of the occupied transmitter bandwidth away from the limits for proper operation.

Enter the transmit frequency in MHz (the resolution of the frequency is .250 MHz). The receive frequency will automatically be programmed as follows:

For A models, RX Freq = TX freq + Freq Duplex.

For B models, RX Freq= TX Freq – Freq Duplex.

In some cases the Freq duplex can be changed, but typically this will not be necessary. Changing the Freq duplex will automatically change the RX frequency. The opmode must be off to set the frequency.

First set the local end transmit frequency:

```
(CLI-config)# freq 22300
Tx Freq:                22300.00 (MHz)
Rx Freq:                23500.00 (MHz)
Freq Duplex:            1200.00 (MHz)
```

Next, Set the far end transmitter frequency (separate session with the other radio)

```
(CLI-config)# freq 23500
Tx Freq:                23500.00 (MHz)
Rx Freq:                22300.00 (MHz)
Freq Duplex:            1200.00 (MHz)
```

If the system has been installed and the far end transmitter is also on the link can be checked using the *linktest* command

```
(CLI-config)# linktest
          LOCK      RSSI      MSE      BER
1>        1       -45.00  -36.70  0.00E+00
```

Step 5: Enable Adaptive Coding and Modulation (ACM) (Optional)

If ACM is desired, the *acm enable* command should be used on both ends of the link.

IMPORTANT: After the ACM is enabled after initial link establishment, the speed command must be reissued.

```
(CLI-config)# acm enable on
ACM enable:          on
```

```
SUCCESS
```

The two steps above must be done on both ends of the link, starting with the unit that does not have output band management or which relies on the GigaPlus IBM connection for management

Step 6: Set the Speed and Modulation

The speed setting may require a license key if the resulting payload speed is above 100 Mbps. The command **speed** shows the current modulation, Bandwidth in MHz, Symbol Rate in Msym/sec, and the payload speed (capacity) in Mbps.

```
(CLI-config)# speed
Modulation:          128QAM
Bandwidth:           20.00
Symrate:             17.42
Speed:               111.00
```

Step 7: Enable the Transmitters

Turn **opmode on** on both ends of the link. This enables the transmitter on the unit. After the opmode is turned on, the TX frequency cannot be changed unless opmode is turned off again.

```
(CLI-config)# opmode on
Opmode:              on
```

SUCCESS

Step 8: Verify the link is working

Run the **linktest** command to confirm that the link is running properly after enabling ACM. Notice that the Tx and Rx modulation levels are now shown. Now, if the link conditions degrade due to rain fading, either the Tx or Rx may downshift during the fade event. Running the **linktest** command again will show the lower modulation such as 64QAM, 32QAM, etc. for Tx or Rx. The RSSI will also likely change for rain fading, but may remain unchanged if the link degradation is due to multipath. The modulation/RSSI will automatically return to the set value once the fading condition has passed.

```
(CLI-config)# linktest
```

	LOCK	RSSI	MSE	BER	TX	RX
1>	1	-38.00	-35.00	0.00E+00	128QAM	128QAM

Step 9: Save the configuration

Run the ***config save*** command to save all the settings that were changed into non-volatile FLASH memory. If a power interruptions should occur, the link will re-establish itself after the interruption is over. (assumes ***default_opmode on*** was enabled and the configuration saved prior to the power interruption).

CLI Based 1+1 Hot Standby Configuration

This section assumes that the physical installation has been done already. Return to the Installation section and connect the units in a 1+1 configuration if required.

Steps to configure 1+1 Hot Standby:

- 1) Follow the 1+0 configuration section to establish a link between the two main ends of the link, with the second pair of radios turned off. The antennas should be aligned at this point.
- 2) Connect the redundancy cable CBLDAT-RIU3 between the two IDUs if not already connected.
- 3) For both ends of the main link:
 - a. Set the failover function to ON using the **failover** command.
failover 1 will enable failover with data ports off on the standby
failover 2 will enable failover with data ports on for all units.
 - b. Set **opmode on**.
 - c. Set **default_opmode on**.
 - d. Save the configuration using **config save**
- 4) Wait approximately one minute and use the **utype** command to confirm that the active radios have taken the active role and the election period is over. In **utype** the current utype should show as active and election period should show as no before continuing or the radios will complete an election process to determine the active and standby roles.
- 5) Bring the second link (Standby) up. If the primary link is in production, ensure the standby units have been programmed with default_opmode off.
 - a. Set the failover function to ON using the **failover** command on both ends of the standby link.
 - b. The new units should detect the active radios and have the saved configuration sync'd from the active to the standby.
- 6) Verify by using the **utype** command on all radios to ensure protection is enabled and all radios are synchronized after a few minutes.
- 7) Use **config save** on all units to ensure the sync'd configuration is saved.
- 8) If desired, test a hardware switchover with **utype_switch**.

Antenna Alignment

After Basic Setup of the link, the antennas can be aligned.

Aligning narrow beam width (< 2 deg) over long distances can be a difficult process without the proper equipment, patience, and a careful process.

Using a GPS compass and the Path Analysis to establish a crude azimuth and elevation, the installation crew can mount the Antenna Assembly on the supporting structures at each end of the link. Once the antennas are installed and a rough antenna alignment has been established, then the fine alignment process can begin at one end of the link (typically the site with the smaller antenna).

Once one side is aligned to achieve best RSSI, MSE, and BER then the operator can adjust the other side to improve the link. Alignment can be done using the `linktest` command from the command line interface, or the voltage indication from the BNC connector on the ODU.



Figure 58 BNC Connector for RSSI Voltage

Run the `linktest` command while aligning the antenna and look for the MSE to improve (a higher negative number) while adjusting. When the lock status changes to 1, you may fine tune the alignment with the LED display

Antenna Alignment Procedure

1. Ensure that both sides of the link are configured correctly.
2. Connect to the management port of the GigaPlus.

3. Login to the end of the link that is being aligned.
4. Run **linktest 99** command while adjusting the antenna(s), and monitor the BNC output voltage until the expected voltage/RSSI level is reached.

The voltage at the BNC will range from 0.1 Volts at -90 dBm input level to 4.5 Volts at -20 dBm input level. Use a voltmeter and CBLDAT-RSSI to monitor the voltage while adjusting the antenna. The following equation can be used to determine the RSL within 3 dB accuracy

$$\text{RSL (dBm)} = 15.77 \times V_{\text{BNC}} - 91.58$$

Below is a table showing the voltage to RSL for convenience.

Voltage (Volts)	RSSI (dBm)
0.1	-90
0.25	-87.6
0.5	-83.7
0.75	-79.8
1	-75.8
1.25	-71.9
1.5	-67.9
1.75	-64
2	-60
2.25	-56.1
2.5	-52.2
2.75	-48.2
3	-44.3
3.25	-40.3
3.5	-36.4
3.75	-32.4
4	-28.5
4.25	-24.6
4.5	-20.6

Table 13 RSSI to Voltage Conversion

5. Once satisfied with the RSSI reading, tighten down the antenna in the optimum position.
6. Replace the sealing cap on the BNC connector and tighten until it clicks into place.

CLI Common Task Reference

Setting up the In-Band-Management (IBM)

Trango pre-configures the links with IBM already set up and enabled, with tagging off, however it will typically be necessary to change the IBM IP addresses used to fit the application management network . This section covers the setup of the IBM.

Display the IBM settings. In the example below the IBM is off.

```
(CLI-config)# ibm
IBM Enable:          off
IBM Tagging:         off
IBM Vlan ID:         100
IBM IP address:      172.16.1.1
IBM Netmask:         255.255.0.0

SUCCESS
```

Enable IBM using the settings preloaded.

```
(CLI-config)# ibm enable on
IBM enable:  on

SUCCESS
```

Change the IBM IP address and subnet mask. Each end of the link should have a different IP address, and in the case of multiple daisy chained links, the IPs should all be different.

```
(CLI-config)# ibm ip 172.16.1.2 255.255.255.0
IBM IP Address:  172.16.1.2
IBM netmask:     255.255.255.0
```

SUCCESS

Verify the settings are correct.

```
(CLI-config)# ibm
IBM Enable:          off
IBM Tagging:         off
IBM Vlan ID:         100
IBM IP address:      172.16.1.2
IBM Netmask:         255.255.255.0
```

Verify the connection to the other end of the link by entering the debug node and using the ping command inside the GigaPlus. In the example, the other end of the link has an IP address of 172.16.1.1.

```
(CLI-config)# debug
```

Ping the other side of the link using the **ping** command from within the debug node of the radio.

```
debug> ping 172.16.1.1
PING 172.16.1.1 (172.16.1.1): 56 data bytes
64 bytes from 172.16.1.1: seq=0 ttl=64 time=6.672 ms
64 bytes from 172.16.1.1: seq=1 ttl=64 time=1.001 ms
64 bytes from 172.16.1.1: seq=2 ttl=64 time=0.979 ms

--- 172.16.1.1 ping statistics ---
3 packets transmitted, 3 packets received, 0% packet loss
round-trip min/avg/max = 0.979/2.884/6.672 ms
```

Note: Besides **ping**, It should be noted that from the debug prompt a telnet session can be run to configure the far end if desired. It should be kept in mind that any

change that would break the link will result in loss of control to the far side. Changes to parameters like frequency, speed, or opmode should be done with care.

Return to the command line interface using the *cli* command. Upon returning from the debug prompt, the system will be in the view node, so the user must log into the config node if any further changes are required.

```
debug> cli
Trango System: TrangoLINK GigaPlus Command Line Interface v3.0.0
```

Return to the config node using the *config* command

```
(CLI-view)# config
Password:
```

IBM may function with VLAN tagging enabled or disabled. With IBM tagging on, a VLAN must be used to access the radio via IBM. With IBM tagging off, traffic that is not tagged with a VLAN will reach the radio via the data ports. While IBM can be used in either method, Trango's recommendation is that IBM be used with a dedicated management VLAN with the highest CoS setting on this VLAN to ensure critical management traffic is never dropped due to traffic flooding conditions.

After changing the IBM tagging state, the config must be saved and the radio must be rebooted for the setting to take effect.

```
(CLI-config)# ibm tagging on
IBM Tagging: on
(CLI-config)# config save
New configuration saved

SUCCESS
(CLI-config)# reboot
```

Capacity License Activation

Activate the traffic capacity license if needed. License keys are typically installed at the factory prior to shipment. Should the operator wish to re-enter the license keys, use the **license** command as shown below

```
(CLI-config)# license 2 <alphanumeric key>
License:                License 2
SUCCESS
```

Automatic Transmit Power Control (ATPC) Configuration (optional)

Configure the Automatic Transmit Power Control (ATPC) if required. ATPC is typically only required if the link is so short that the max transmit power cannot be used due to receiver overload, or for regulatory reasons.

First check the ATPC status. If the ATPC is off then the ATPC can be enabled using the **atpc enable on** command. In the example below the max power is currently 19 dBm

```
(CLI-config)# atpc
ATPC Enable:            on
ATPC Step Size:        1
ATPC Max Power:        19.00
```

Next, set the ATPC max power based on the highest modulation that will be used. In the example below, the highest transmit power that will be used is +17 dBm, so the **atpc max_power** is set accordingly.

```
(CLI-config)# atpc max_power 17
ATPC max power:        17.00
```

SUCCESS

```
(CLI-config)# atpc
ATPC Enable:            on
ATPC Step Size:        1
ATPC Max Power:        17.00
```

Next, set the target receiver level that will be used to control the far end transmitter power. If the RSSI is too high, then the ATPC software will send an ATPC power down command to the other end of the link.

The **targetrssi** must be set on both ends of the link, just as the ATPC max power. The ATPC software will stop sending commands to the other end of the link when the RSSI is within + / - 2 dB of the set target rssi level.

```
(CLI-config)# targetrssi
Target RSSI:          -45.00
```

```
(CLI-config)# targetrssi -40
Target RSSI:          -40.00
```

```
SUCCESS
```

Check Ethernet and RF port Statistics

Run the **status port** command

This command shows the current Ethernet port statistics and to provide confirmation that the connection to the network equipment is set up properly. The system default is auto-negotiate. The ge1 and ge2 ports are mapped to the copper ports, and ge3 and ge4 are mapped to the SFP data ports, and the ge0 port is the interface from the internal switch inside the ODU to the modem.

The ge0 statistics are typically not monitored and are made available for troubleshooting purposes only. The RF counters indicate the statistics for the receive port and the transmit port.

The Octet/Packet counts on the RF counters may be slightly higher due to internal messaging between the two ends of the link for internal link management, and again they are primarily for troubleshooting purposes and do not need to be monitored continuously.

Monitoring the RF drop counts is useful for determining if errors are occurring over the wireless portion of the link.

The port rate and port utilization (percent) are also useful for monitoring since they can indicate a link running at capacity. These two metrics account for the sum of all the Ethernet ports being used.

```
(CLI-config)# status port
```

```
<===== Ethernet Counters =====>
Port:          ge1      ge2      ge3      ge4      nternal
Enable:        on       on       on       on       on
Status:        off      off      off      off      on
Duplex:        full     full     full     full     full
Speed:         1000    1000    1000    1000    1000
In Octets:     362607   4535496 0        0        2698731294
In Ucast Pkt:  4444    2617317006 0        0        2323868109
In NUcast Pkt: 136      0        0        0        1
Out Octets:    922671622 1719593480 0        0        3076730927
Out Ucast Pkt: 14415821 2308569723 0        0        652052464
Out NUcast Pkt: 1        135     0        0        136
CRC Errors:    0        0        0        0        20
CollisionError: 0        0        0        0        0

<===== RF Counters =====>
                IN                OUT
Total Octets:   4280834626   3284730808
Total Pkt:     2328890117   653833881
Total Drop Pkt: 20           N/A
Port Rate(Mbps): 0            0
Port Util(%):  0            0
```

Run the ***status clear*** command

After the link has been established and the Ethernet interfaces are running properly, the counters may all be cleared. This is typically done just prior to the link validation phase in which a fixed amount of traffic or packets are passed over the link over a period of time to ensure no drops occur. The status clear command will clear all port counters and the BER counters.

```
(CLI-config)# status clear
```

Run the ***syslog clear*** command

Before deployment it is a good idea to clear the syslog so that only events after the link was commissioned are recorded. Run the syslog clear command.

```
(CLI-config)# syslog clear
```

```
(CLI-config)# syslog
```

```
Current 0:19:24:25.990
```

View the model information using the **model** command

```
(CLI-view)# model
```

```
IDU Model:          IDU-GigaPlus-1
```

```
IDU Serial ID:     8480068
```

```
ODU Model:         HP2-23-1200-3A
```

```
ODU Serial ID:    C110301327
```

```
Tx Freq Min:      22000.00
```

```
Tx Freq Max:      22400.00
```

```
Freq Duplex:      1200.00 (MHz)
```

Enable Traps (Optional)

Traps can be used to notify external network monitoring devices that a threshold parameter has been crossed. Thresholds are available for the following:

- RSSI
- MSE
- BER
- FER
- OMU_TEMP
- ODU_TEMP
- OUT PORT UTILIZATION (percentage of max available)
- IN PORT UTILIZATION (percentage of max available)
- Link Down

If thresholds have been set and SNMP Trap assigned as an action, the crossing of the threshold will generate a trap.

The current trap information using the **trap** command. The current trap manager IP addresses are shown along with their individual status:

```
(CLI-config)# trap
```

	IP	Enable
Trap 1:	0.0.0.0	off
Trap 2:	0.0.0.0	off
Trap 3:	0.0.0.0	off
Trap 4:	0.0.0.0	off
Trap 5:	0.0.0.0	off

Set the trap 1 manager IP address using the **trap ip** command – repeat for additional trap manager ip addresses:

```
(CLI-config)# trap ip 1 10.14.1.5
```

	IP	Enable
Trap 1:	10.14.1.5	off

SUCCESS

Enable the trap number 1 using the **trap enable 1 on** on command – The trap will be enabled and the status shown:

```
CLI-config)# trap enable 1 on
```

	IP	Enable
Trap 1:	10.14.1.5	on

8.0 Troubleshooting

This section provides troubleshooting advice for problems that may be encountered during setup and normal operation of the system.

Symptom: No Link (Lock = 0 during linktest)

- 1) TX Frequency must EXACTLY match the RX frequency on the remote side. Type **freq** command from the CLI to view. Verify that the frequencies used match the regulatory body (FCC or equivalent) approved frequencies.
- 2) Opmode is off. Run **opmode** command to view, and run **opmode on** to enable. If the unit was rebooted and the default opmode is not on, the unit will come back on but the opmode will be off. To prevent, run **default_opmode** on command and **config save**.
- 3) Are the frequencies configured correctly on each radio (TX and RX)? High frequency on the “B” side and low frequency on the “A” side..
- 4) Is the ODU unit installed properly on the remote mount (remote mount applications only)? The system unit will only operate in a single orientation on the remote mount. Follow the directions on the remote mount to ensure correct installation. The arrows on the Remote mount must be aligned with the “V” on the ODU.
- 5) Are both ODUs at the ends of the link mounted on the same polarization? ODUs must be mounted with matching polarizations at each end of the link. If one side is mounted on the antenna differently than the other side, the link will not lock or the signal level will be 20-30 or more dB lower than expected.
- 6) IF ACM is being used, ACM may not be enabled on both ends of the link. Enable the ACM and reset the speed on each end. The speed must be set the same on both ends.

MSE is too high and/or bit errors are showing when running linktest

NOTE: MSE= -32 dB or lower is typical for 256 QAM, -29 is a worse number and is not typical

- 1) Is the transmitter power set too high for the current modulation being used. Consult the license information to verify that the power level is no higher than the maximum allowed for the highest modulation that will be used.
- 2) Target RSSI setup may be incorrect. It is best to set the target RSSI as high as possible without overdriving the receiver for the most robust operation. Setting the target RSSI too close to the RX sensitivity threshold will compromise the link integrity.
- 3) Are both GigaPlus ODU's mounted on the same polarization? ODU's must be mounted with matching polarizations at each end of the link. If one side is mounted on the antenna differently than the other side, the link will not lock or the signal level will be 30 or more dB lower than expected.
- 4) Is the ODU installed properly on the remote mount (remote mount applications only)? The ODU will only operate in a single orientation on the remote mount. Follow the directions on the remote mount to ensure correct installation. The Arrow on the remote mount must line up with the "V" on the ODU.
- 5) Presence of microwave transmitters on same frequency (uncommon): To check for possible interference from other licensees, turn off the opposite end transmitter and run the *rsi* command. The signal level should be -90 or lower. The level should be steady within a dB or so.

Receive Signal Level is too low

- 1) Target RSSI setup may be set incorrectly (when using ATPC only). It is best to set the target RSSI as high as possible without overdriving the receiver for the most robust operation. Setting the target RSSI too low will result in a signal level lower than what is expected if ATPC is enabled .
- 2) Reported RSSI more than 3 dB off the expected RSSI: There may be an alignment problem with one or both antennas, especially if both sides of the link show the

same symptom. **A mis-aligned antenna is one of the most common installation problems.**

Solution: Realign the antenna(s). Opmode must be on at the remote side of the link to do alignment of the local side. **Ensure that ATPC is off.**

- 3) Are both ODUs mounted on the same polarization? ODUs must be mounted with matching polarizations at each end of the link. If one side is mounted on the antenna differently than the other side, the link will not lock or the signal level will be 30 or more dB lower than expected.
- 4) Is the ODU installed properly on the remote mount (remote mount applications only)? The radio unit will only operate in a single orientation on the remote mount. Follow the directions on the remote mount to ensure correct installation. The Arrow on the Remote mount must line up with the "V" on the ODU.

RF Link is good but packet loss is occurring:

- 1) Verify the duplex and speed settings in the Ethernet port are correct (100 or 1 Gbit) and match the connected equipment, and that no CRC errors on the port are occurring.
- 2) Verify that the Ethernet ports are connected properly. The GigaPlus family of Radios are port mapped, meaning that the traffic going into Ethernet port 1 on the local side will only appear at port 1 of the remote side, local side port 2 traffic will appear on the remote side port 2, etc..
- 3) Check the Ethernet cables for correct wiring. If 1000BaseT is being implemented, Cat5e or Cat6 cable should be used. Ensure that the cable is shielded and proper grounding is applied to the RJ45 connector.

No direct management using Out of band port

If you cannot telnet into the IDU or open an HTTP browser session,

- 1) Check your Ethernet and power cable connections
- 2) Ensure proper cable is being used cross-over vs. straight-through cable. The LEDs on the Ethernet port should be illuminated.

- 3) Check PC's subnet to make sure it is routable to the radio's IP address.
- 4) Ensure snmpd is enabled
- 5) If a firmware upgrade was just performed and one file did not load properly and the system rebooted, you will lose management. Please call Technical Support for further assistance.

No Radio Management connection over the link

- 1) Verify the In-Band management is set up properly - Check to see if the IP configuration is correct, the VLAN ID is set and matches on both ends, and that IBM is enabled.

T1/E1 Ports not passing traffic

- 1) Mismatched T1 ports, since the T1 ports are port mapped T1 port 1 on IDU one must be connected to T1 port 1 on the second IDU.
- 2) Ensure the port is enabled using the *datapath* command. The datapath must be set to Eth + T1 or Eth+E1 , the config saved, and the system rebooted at both sides.
- 3) Verify pin outs of the T1/E1 RJ45 connector
- 4) GigaPlus-Key-PDH License Key not activated

If there are still problems please contact Technical Support at 858-391-0010 or Email at techsupport@trangosys.com

Before calling please make sure you have the following information.

- Serial Number
- Description of the problem
- Steps taken so far to resolve the problem
- Commissioning log

Appendix A – Command Line Interface Reference

This Appendix provides a standalone guide to the commands available through the Telnet, SSH, and console port of the GigaPlus.

Command Keying Overview

Key Functions

Tab - Autocomplete

Completes a partial command name entry. When you enter a unique set of characters and press the Tab key, the system completes the command name. If you enter a set of characters that could indicate more than one command, the system beeps to indicate an error. Enter a question mark (?) immediately following the partial command (no space). The system provides a list of commands that begin with that string.

Del or Backspace

Erases the character to the left of the cursor.

Return

At the command line, pressing the Return key performs the function of processing a command. At the –More-- prompt on a terminal screen, pressing the Return key scrolls down a line.

Space Bar

Allows you to see more output on the terminal screen. Press the space bar when you see the More prompt on the screen to display the next screen.

Left Arrow

Moves the cursor one character to the left.

Right Arrow

Moves the cursor one character to the right.

Up Arrow

Recalls commands in the history buffer, beginning with the most recent command. Repeat the key sequence to recall successively older commands.

Down Arrow

Return to more recent commands in the history buffer after recalling commands with the Up Arrow or Ctrl-P. Repeat the key sequence to recall successively more recent commands.

Different Node Levels

View Node

This is the default node the users log in. This is strictly for viewing configuration and statistics only. No configuration changes can be made at this level.

View Node Command List

acm	Display ACM feature status
alarm	Display Alarm status
alignment_sp	Display alignment mode status (SP ODUs only)
atpc	Display ATPC status
ber	Display ber test parameters
cableloss	Display Cable loss values (SP ODUs only)
config	Enable Trango configuration mode
cos	Display current status for class of service
datapath	Display datapath from FPGA
datapattern	Display data source for data pattern
date	Display Time of Day
default_opmode	Display default opmode status
egress_margin	Display the current egress margin setting
eth_info	Display ethernet port status and configuration
failover	Display failover (1+1 HSB) mode
fanctrl	Display Fan status
freq	Display Rf Tx/Rx frequency
guard_time	Display failover guard time
help	Display help command
httpd	Display Web server (httpd) status
lbn	Display In Band Management configuration

iduled	Display the iduled function (TDM or RSSI)
ipconfig	Display radio management port configuration
license	Display license enable status
link_history	Display how many times link dropped since power on
linktest	Display link test values (RSSI, MSE, BER)
loglevel	Display the current loglevel for the syslog
loopback	Display loopback Mode
model	Display IDU/ODU Model and serial number
mse	Display the MSE (Mean Square Errors) value
oduled	Display ODU rssiled status
odupower	Display ODU Power status
odurxagc	Display ODU Rx AGC status
opmode	Display Operation Mode status
power	Display Tx power in dBm
remark	Display product remarks
rps	Display current status of rapid port shutdown
rsi	Display RSSI value
show	Show running system information
siglevel	Display signal path debugging parameters
smart_mode	Display the current smart mode status (on/off)
snmpd	Display SNMP Agent Daemon (snmpd) status
speed	Display current modulation and symbol rate(speed)
status	Display status for different device and ports
sync_status	Current 1+1 HSB peer sync status (Failover active)
sysinfo	Display MSE, FER information
syslog	Display system event log
targetrsi	Display target rsi value
tdm	Display TDM configuration
telnetd	Display telnetd server (telnetd) status

temp	Display IDU and ODU temperature
tftpd	Display tftp server (tftpd) status
threshold	Display threshold status
trap	Display SNMP Trap IP configuration
uptime	Display system uptime
Utype	Display the current unit type (Active or Standby)
version	Display IDU/ODU Software version
voltage	Read voltage values from PIC

Config Node

Users can enter this node by typing in the command “config” from the view node. They will be prompted for a password and after successful authentication users enters the config mode. All configuration settings can be changed here.

- All the commands entered without any parameters returns the current configured values and are similar to “view” node.
- All configuration changes are applied immediately and don’t require any reboot (except “speed” in which the settings are applied immediately, but it does require reboot after save).
- All configuration changes have to be saved in order to be persistent across reboot. A single “save” command will save all configuration changes
- Users can go back to the “view” node by typing in the command exit

Config Node Command List

CLI	Ranges	Default Value
acm	enable <on off>, mod	Off
alarm	Alarm 1 and 2 <on off>	Off
alignment_mode	<on off>	Off
atpc	enable <on off>, max_power, step_size	Off
ber	<1-99> seconds	N/A

bootimage	<upgrade toggle> <idu/odu>	N/A
cableloss	<0-20> <0-30> <0-50>	0,0,0
config	execute,export, import,remove,save, view	N/A
custom_profile	add, remove	N/A
datapath	<0-2>	2
datapattern	<internal external>	external
date	year<0-99>,month<1-12>,date<1-31>, hour<0-23>, minute<0-60>	Linux System Date
debug	N/A	N/A
default_opmode	<on off>	Off
diagnostic	N/A	N/A
egress_margin	<5-20> percent	10 percent
eth_info	<1-6>	N/A
exit	N/A	N/A
failover	<on off>	off
fanctrl	<0-2>	1
freq	depends on ODU model	0 (this is exception to the valid range)
freq_duplex	ODU dependent	N/A
ftp	N/A	N/A
get	N/A	N/A
guard_time	10-30 seconds	15 seconds
help / ?	N/A	N/A
httpd	<on off>	On
ibm	<on off> <ip address> <Vlan>	off
iduled	<0 1> (TDM RSSI)	RSSI
ipconfig	<ip address><netmask><gateway>	ip 192.168.100.100
		netmask: 255.255.255.0
		gateway: 192.168.100.100

		Reset will not reset ipconfig, use “reset ipconfig” to reset the ip address settings.
license	N/A	None
		N/A
license_speed	<1-2> <key>	N/A
license_tdm	key	N/A
link_history	N/A	N/A
linktest	duration <1-99>	Default 1 (if duration not entered by user)
loglevel	<0: Setting, 1: Event, 2: Status>	0,1
loopback	<dig if rf_gen rf_refl off>	Off
loopback_auto	N/A	N/A
model	N/A	No defaults, read directly from the IDU/ODU
mse	duration <1-99>	Default 1 (if duration not entered by user)
oduled	<on off>	On
odupower	<on off>	Off
odurxagc	<on off>	Off
opmode	<on off>	Off
passwd	<passwd> <confirm_passwd> (8char)	trango
port	<eth > <1-4> <auto_nego, duplex, enable, maxrate, pause, priority, speed	All 4 ports configured in the Auto-Neg Mode
power	0-30	10dBm
prompt	Character string	N/A
qos	priority<0-7>, dscp_weight <1-15>, mode<strict/WRR>	1 to 1 COS mapping, strict mode Priority 0: COS Queue = 0 Priority 1: COS Queue = 1 Priority 2: COS Queue = 2 Priority 3: COS Queue = 3 Priority 4: COS Queue = 4 Priority 5: COS Queue = 5 Priority 6: COS Queue = 6 Priority 7: COS Queue = 7

qos_info	port<1-4>	Port 1 DSCP mappings shown
reboot	N/A	N/A
remark	<string 1-100bytes>	TrangoLink GigaPLUS
		Reset will not change the remark settings
reset	N/A	N/A
reload in x	<1-240> minutes	10 minutes
rps	<on off>	off
rsi	Duration <1-99>	Default 1 (if duration not entered by user)
show	<passwords>	CLI View Node: trango
		CLI Config Node: trango
		SNMP read comm: public
		SNMP write comm: private
		Web Interface: trango
		snmp trap: trapstr
siglevel	N/A	N/A
smart_mode	<on off >	On
snmpd	<on off >	On
speed	<channel_bw> <modulation>	<30> <qam32>
channel_bw	4/5/7/8/10/12/14/20/25/28/30 /40/50/55/56/80	30
modulation	qpsk, qam16, qam32, qam64,qam128,qam256	qam32
status	<clear/compare/modem/pll/port/ Remote/save/tdm>	N/A
sync	N/A	N/A
sync_status	N/A	N/A
sysinfo	<0-6>	0 (if command executed without any param)

syslog	<clear>	N/A
targetrssi	<-88 - -25)	-40
tdm	<coding. <mode>	AMI T1
telnetd	on/off	on
temp	N/A	N/A
tftpd	<on off>	Off
threshold	<param> <min max> <value> <action>	Default action is None.
	param : 0 rssi, 1 mse, 2 ber, 3 fer, 4 idu_temp, 5 odu_temp	
	min max: param dependent	
	action: 0 none, 1 alarm1, 2 alarm2 ,3 snmptrap	
trap	<enable, ip, cr>	0.0.0.0
		Reset will change the prev configured trapip
enable	<0 - 5>	N/A
ip	<1 -5 > <A.B.C.D>	N/A
cr	N/A	N/A
uptime	N/A	N/A
utype	N/A	Main
utype_switch	N/A	N/A
version	N/A	N/A
voltage	N/A	N/A
web_refresh_rate	<2-300 seconds> <0> to disable	5

Debug Node

This node is additional management port related settings and users enter the debug node, by typing in the *debug* command from the config node. Users can re-enter the view node by entering the *cli* command from within the debug node.

Debug Node Command List

cli	N/A	Used to Enter the CLI (trango-view) node
exit	N/A	Exit out of the session (clean exit)
help	N/A	Display list of commands in the debug node
ping	<ip address>	ping network hosts
passwd	<password>	Reset the main password into view node
route	N/A	Display the current system routing table
ssh	<ip address>	ssh into another host
syslog	N/A	print system log
telnet	<ip address>	telnet into another host
uptime	N/A	Display the current uptime and system load
tg_reboot	N/A	Reboot radio

Individual Command Details

acm

<p>SYNTAX</p>	<p><i>acm</i></p> <p><i>acm enable < on off ></i></p> <p><i>acm mod <modulation> mse_im <-40 - 0></i></p> <p><i>acm mod <modulation> mse_de <-40 - 0></i></p> <table border="1" data-bbox="456 720 1105 1001"> <thead> <tr> <th>profile</th> <th>mse_im</th> <th>mse_de</th> </tr> </thead> <tbody> <tr> <td>QPSK</td> <td>-20.3</td> <td>NA</td> </tr> <tr> <td>16QAM</td> <td>-25.3</td> <td>-18.5</td> </tr> <tr> <td>32QAM</td> <td>-26.3</td> <td>-21.3</td> </tr> <tr> <td>64QAM</td> <td>-29.2</td> <td>-24.3</td> </tr> <tr> <td>128QAM</td> <td>-32.1</td> <td>-27.2</td> </tr> <tr> <td>256QAM</td> <td>NA</td> <td>-27.2</td> </tr> </tbody> </table> <p>Configuration Storage: Yes</p> <p><i>acm</i> without any parameter will display the current status of ACM threshold value and enable options.</p>	profile	mse_im	mse_de	QPSK	-20.3	NA	16QAM	-25.3	-18.5	32QAM	-26.3	-21.3	64QAM	-29.2	-24.3	128QAM	-32.1	-27.2	256QAM	NA	-27.2
profile	mse_im	mse_de																				
QPSK	-20.3	NA																				
16QAM	-25.3	-18.5																				
32QAM	-26.3	-21.3																				
64QAM	-29.2	-24.3																				
128QAM	-32.1	-27.2																				
256QAM	NA	-27.2																				
<p>DESCRIPTION</p>	<p><i>acm</i> is used to display ACM features parameters including ACM enable, and MSE values in the improve/degrade threshold tables.</p> <p><i>acm enable</i> is used to turn on the adaptive coding and modulation feature. When enabled, the current TX/RX modulation may shift to different profile based on the current MSE value and a set of pre-defined MSE degrade and improve thresholds. <i>The speed command needs to be issued after “acm enable on/off” command.</i></p> <p>ACM is not symmetric and each end (TX/RX) may have different profiles at a given time depending upon the MSE values on each end.</p>																					

acm mod is used to update MSE value for degrade or improve threshold table. The new threshold values should be effect immediately upon execution.

Depending on the speed set, certain modulations are not available. For example, when initial speed modulation is at QAM256, the available modulation levels and thresholds are:

profile	mse_im	mse_de
QPSK	-20.3	-17.10
16QAM	-25.3	-18.5
64QAM	-29.2	-24.3
256QAM	-32.1	-27.2

Note: the default values provided ensure hitless transitions between modulation levels. Any changes made by the user cannot be guaranteed to result in hitless modulation transitions.

alarm

<p>SYNTAX</p>	<p><i>alarm</i></p> <p><i>alarm</i> <<i>alarm1</i> <i>alarm2</i>> <<i>on/off</i>></p> <p>Default: alarm 1 OFF, alarm 2 OFF</p> <p>Configuration Storage: No</p> <p><i>alarm</i> without any parameter will display the current status for both alarm1 and alarm2</p> <p><i>alarm</i> is a system-level command.</p>
<p>DESCRIPTION</p>	<p>User may specify alarm1 or alarm2 as the action in the threshold settings. This command is used to turn off the alarm after the alarm has been</p>

	<p>triggered, or turn on an alarm remotely.</p> <p>Alarms are also set by the system internally when certain configured thresholds are exceeding its expected range.</p>
--	--

atpc

<p>SYNTAX</p>	<p><i>atpc</i></p> <p><i>atpc enable</i> < on off ></p> <p><i>atpc max_power</i> <0-30></p> <p><i>atpc step_size</i> <0-5></p> <p>Default: enable OFF, max power 17 dBm, step size 1</p> <p>Configuration Storage: Yes</p> <p><i>atpc</i> without any parameter will display the current status of ATPC feature</p>
<p>DESCRIPTION</p>	<p><i>atpc</i> is used to display ATPC features parameters including ATPC step size, ATPC enable, and ATPC max power.</p> <p><i>atpc enable</i>: ATPC is used to automatically adjust the remote end ODU transmit power in order to maintain the desired level of RSSI (within 2 dB range of targetrssi) at the local end. This feature will work only when both local and remote radio are enabled.</p> <p><i>atpc max_power</i>: Set the maximum ATPC power. This parameter is used only when the ATPC is enabled.</p> <p>User cannot execute the <i>power</i> command when ATPC is turned on. The system will adjust the power automatically based on the “max_power” and “step_size”.</p> <p><i>atpc step_size</i>: Specified the step size for each of the ATPC command for power up/down</p>

	<p>By default, for each of the atpc power up/down command from the remote unit, there will be 1 dB increment/decrement. The user may specify this step size to maximum of 5 dB per command. The <i>power</i> command to ODU is 1 dB at a time, but will go up to number of step size per ATPC command.</p> <p>The user is responsible for meeting legal/regulatory requirements for Tx power.</p>
EXAMPLE	<i>(CLI-view) atpc</i>

ber

SYNTAX	<p><i>ber</i></p> <p><i>ber <0-99 duration in seconds></i></p> <p>Default: 1 second</p> <p>Configuration Storage: Yes</p> <p><i>ber</i> without any parameter will display the current BER, LOCK, MSE, RSSI values</p>
DESCRIPTION	<p>BER applies to Ethernet Data only, and is based on CRC. FCs errors , and only is functional when the datapattern is set to internal mode. It will always be zero on live traffic (external datapattern).</p>

bootimage

SYNTAX	<p><i>bootimage toggle</i></p> <p><i>bootimage upgrade <idu odu></i></p> <p>Default: N/A</p>
---------------	--

	<p>Configuration Storage: NO</p> <p><i>bootimage</i> is a system-level command.</p>
DESCRIPTION	<p><i>bootimage toggle</i>: To switch current images back to the previous updated image in a set of FPGA1, FPGA2, OS, FW. PIC and ODU firmware are not allowed to be toggle back unless performing <i>bootimage upgrade</i> again.</p> <p><i>bootimage upgrade</i>: upgrade the required software images on the radio, after the image is transferred on the radio via tftp.</p> <p><idu> option will upgrade all the IDU firmware in sequence of FPGA, OS, FW, PIC from ONE tar file under /tmp/idu_GigaPlus_vX.X.tar “reboot” is required after the idu upgrades.</p> <p><odu> option will upgrade ODU firmware with the file under /tmp/odu_fw.bin or /tmp/rem_fw.bin (name is not exchangeable)</p>

cableloss

SYNTAX	<p><i>cableloss</i></p> <p><i>cableloss</i> <loss140> <loss315> <loss915></p> <p>Default: 0 for all three channels</p> <p>Configuration Storage: Yes</p> <p><i>cableloss</i> without any parameter will display the current cableloss values for the IF cable going to the ODU</p> <p>Valid range of operation:</p> <p><i>loss140</i>: range 0-15, <i>loss315</i>: range 0-26, <i>loss915</i>: range 0-50</p>
---------------	---

DESCRIPTION	<p><i>This command is only applicable for SP ODUs connected to IDUs that use hardwareID = 1</i></p> <p><i>cabloss</i> command is used to set the appropriate cable loss (in dB) for the 3 frequencies based on the length of the IF coaxial cable used to connect the IDU and ODU.</p> <p><i>cabloss</i> info must be sent to the ODU so that it can maintain the output Tx/Rx power levels accurately. This only applies to SP ODUs. For systems with HP ODUs no <i>cabloss</i> setting is required. The cable loss compensation is built in into the HP ODU.</p>

config

SYNTAX	<p><i>config execute</i></p> <p><i>config export</i></p> <p><i>config import</i></p> <p><i>config remove</i></p> <p><i>config save</i></p> <p><i>config view</i></p> <p>Default: N/A</p> <p>Configuration Storage: No</p> <p><i>config</i> is a system-level command.</p>
DESCRIPTION	<p><i>config execute</i>: The option allows the user to execute a recently imported config file that was previously saved on a storage media outside the IDU. The file must have been imported using the <i>config import</i> command described below</p>

a ASCII file (config.txt) of the current system

config export: The option allows the user to create a text file (export_config.txt) of the current system configuration, which can then be obtained from the IDU using ftp or tftp from a remote device (PC), which the user can print or import to a different idu

config import: This option allows the user to push a configuration file (must be the same format/name as created by export) into the system through tftp and then issue the “config import” command to apply the settings from the export_config.txt file to the system.

config remove: This option allows removing the current system configuration file config.bin and all settings will be reset to factory defaults. This is different than the “reset config” where all the password settings are also being reset.

config save: Save command is used to save the current system configuration to the flash, so that system settings are persistent across reboot/power cycles.

Save command should be used after any system setting change, otherwise changes will be lost after reboot. Multiple changes can be saved by one save command.

config view: The option displays the current system configuration in ASCII format on the console. The saved config is displayed.

custom_profile

SYNTAX	<i>custom_profile</i> add remove
DEFAULT VALUE	NA
DESCRIPTION	<p>Allow a custom speed profile to be used. The custom file must be created by Trango Systems and verified before use.</p> <p>Custom speed profiles allow changing various parameters such as Channel bandwidth, ACM profile, Latency, Sensitivity, number of T1/E1 tributaries, etc.</p> <p>When loaded, the custom profile will replace the default profile used with the same name and speed setting from that point on.</p> <p>If the user desires to return to the factory default settings for that speed setting, the <i>custom_profile</i> remove command can be used.</p> <p>License keys still apply and are based on the calculated throughput of the profile.</p> <p>Detailed instructions will be provided with the profile. Contact your Trango representative for more information.</p>
RELATED	Speed, license

datapath

SYNTAX	<i>datapath</i> <0-2> 0:ETH only 1:ETH+T1 2:ETH+E1
---------------	---

DEFAULT VALUE	0: Eth Only
DESCRIPTION	<p>Select the profile to be used on the datapath of the radio.</p> <p>A License key is required for TDM (T1/E1) mode.</p> <p>Bandwidth for 8 T1 or 8 E1 circuits always reserved once selected, regardless of whether data is being sent or not. This will reduce the Ethernet capacity accordingly</p> <p>Refer to Appendix A for valid profiles applicable to specific datapath mode</p>
RELATED	Speed, license

datapattern

SYNTAX	<p><i>datapattern</i> <external internal></p> <p>Default: external datapattern</p> <p>Configuration Storage: Yes</p> <p><i>datapattern</i> without any parameter will display the current status</p>
DESCRIPTION	<p>Sets datasource for the modem. <i>datapattern</i> can be generated from either fpga (external) or the modem (internal), used to generate PRBS data</p>

	The datapattern should be set to “external” during normal mode of operation, otherwise no user data from Ethernet or the T1 ports will be transmitted.
--	--

date

SYNTAX	<p><i>date</i> <year> <month> <day> <hour> <minute></p> <p>Default: N/A</p> <p>Configuration Storage: No</p> <p><i>date</i> without any parameter will display the current time of date.</p> <p><i>date</i> is a system-level command.</p>
DESCRIPTION	Allow the user to set and read the current time and date

debug

SYNTAX	<p><i>debug</i></p> <p>Default: N/A</p> <p>Configuration Storage: No</p>
---------------	--

	<i>debug</i> is a system-level command.
DESCRIPTION	Exit current node and enter the debug mode.
EXAMPLE	To enter debug mode (trango-config)# debug debug>
RELATED	cli

default_opmode

SYNTAX	<i>default_opmode</i> <i>default_opmode [on off]</i> Default: default operation mode OFF Configuration Storage: Yes <i>default_opmode</i> without any parameter will display the default operational mode
DESCRIPTION	Set the default opmode to user specified input. If ON, the system to power on with ready to be operational

	<p>if OFF, the user has to explicitly turn on opmode.</p> <p>Opmode settings are dependent upon “default_opmode” after power up</p>
--	---

diagnostics

SYNTAX	<p><i>diagnostic</i></p> <p>Default: N/A</p> <p>Configuration Storage: No</p> <p><i>diagnostic</i> is a system-level command.</p>
DESCRIPTION	<p>Diagnostic command is to communicate with all system devices and get a current snapshot of the system status. This is mainly used for debugging purposes.</p>

egress_margin

SYNTAX	<p><i>egress_margin</i> <-99 to +99></p> <p>Default: 0</p> <p>Configuration Storage: Yes</p> <p><i>egress_margin</i> is a system-level command.</p>
---------------	---

DESCRIPTION	<p>Setting the egress margin adjusts the rate of the egress of packets from the internal switch, after QoS grooming has been done, into the modem portion of the system. By default the rate is matched to the total capacity of the radio for a given speed setting</p> <p>This command only has an effect when traffic into the IDU exceeds the radio capacity.</p> <p>By adjusting the egress rate performance for can be enhanced, especially for predominantly small packets and bursty traffic in overload conditions.</p> <p>A range of -5% to -20 % is useful for improving performance of high priority traffic, at a slight cost of capacity.</p> <p>If high priority traffic is comprised of mostly small packets (<128 bytes), setting the margin to -20% can ensure that all small packets that have high priority will go through (assuming Strict priority or default WRR weighting).</p> <p>For mostly large packet (> 1280 bytes) high priority traffic, the margin should be set to roughly -5 %.</p> <p>For most applications, the default setting of is sufficient.</p>
--------------------	---

eth_info

SYNTAX	<p><i>eth_info</i></p> <p><i>eth_info</i> <1-4> <1-4> <1-4> <1-4></p> <p>Default: N/A</p> <p>Configuration Storage: No</p> <p><i>eth_info</i> without any parameter will display configuration for all 4 ports.</p> <p><i>eth_info</i> is a system-level command.</p>
---------------	---

DESCRIPTION	<p>Display Ethernet port configurations include: enable, status, pause frame, auto negotiation, duplex, priority, speed and max rate.</p> <p>User have the options to display one or more port configuration for up to 4 ports for display</p>
--------------------	--

failover

SYNTAX	<p><i>failover</i></p> <p><i>failover</i> <0:off, 1: On with port OFF, 2: On with port ON></p> <p>Default: OFF</p> <p>Configuration Storage: Yes</p> <p><i>failover</i> without any parameter will display the current status for the failover mode</p>
DESCRIPTION	<p>Display and configure the failover mode feature. Failover cable is required between two IDU for this feature to work properly.</p> <p>Option OFF: Disable failover mode feature.</p> <p>Option ON with port OFF: Standby unit disable all Ethernet / TDM ports.</p> <p>Option ON with port ON: Standby unit will leave the Ethernet / TDM port enabled.</p> <p>When enabled, a KeepAlive message will be exchanged between the two GigaPlus IDU to determine their utype.</p> <p>NOTE: This command will set the utype state to default and perform election period which will affect the radio link. Therefore, it is not recommended to be executed while the link is running with traffic.</p>

EXAMPLE	<pre>(CLI-config)# failover Failover mode: off (CLI-config)# failover on Failover mode: on SUCCESS</pre>
RELATED	cli, config

fanctrl

SYNTAX	<pre><i>fanctrl</i> <i>fanctrl</i> <on off></pre> <p>Default: fan ON</p> <p>Configuration Storage: Yes</p> <p><i>fanctrl</i> without any parameter will display the current status for the fan.</p> <p><i>fanctrl</i> is a system-level command.</p>
DESCRIPTION	<p>Display of the status of the cooling fan in the chassis and allow it to be turned on and off. It is not recommended to turn the fan off if the ambient temperature surrounding the IDU will exceed 10 deg C.</p>

freq

SYNTAX	<p><code>freq [tx_freq in MHz]</code></p> <p>Default: no default frequency. 0</p> <p>Configuration Storage: Yes</p> <p>The setting of frequency can be to the 250 kHz resolution.</p> <p>EXAMPLE: <i>freq 17727.5</i></p> <p><i>freq</i> without any parameter will display the current Tx and Rx frequency for the ODU.</p>
DESCRIPTION	<p>Sets the ODU transmit frequency and then the receive frequency, based on the <code>freq_duplex</code> spacing. In some cases the IDU IF frequency is changed as well (Giga-ODU-xx). In general, for HP ODUs there is no limitation on the Certain IDU/ODU PLL synthesizers are programmed for each and every individual frequency.</p> <p>GigaPlus supports model 6, 6E, 11, 11E, 15, 18, 18E, 23, 23E of SP ODU's</p> <p>And 6-38Ghz HP ODU's</p>

freq_duplex

SYNTAX	<p><code>freq_duplex [duplex]</code></p> <p>Default: 0</p> <p>Configuration Storage: Yes</p>
---------------	--

	<i>freq_duplex</i> without any parameter will display the current duplex value ONLY for HP ODU's
DESCRIPTION	Sets the duplex value to be used for programming the transmit frequency and therefore the receive frequency.

ftp

SYNTAX	<p><i>ftp</i></p> <p><i>ftp</i> <server_ip> <user_name></p> <p><i>ftp</i>> get <file_name>: perform ftp get command. Get file from the ftp server</p> <p><i>ftp</i>> mode: configure ftp operation mode. Passive or active.</p> <p><i>ftp</i>> put <file_name> <server path>: perform ftp put command. Put file to the ftp server</p> <p><i>ftp</i>> logout: logout of ftp session.</p> <p>Default: server_ip=NULL, user_name=NULL, mode=Passive</p> <p>Configuration Storage: No</p>
DESCRIPTION	<p>To perform ftp operation. Provide the command with the ftp server IP and the user login. Enter the password when prompted.</p> <p><i>ftp</i>> get <file_name>: Do NOT supply the path to the file that needs to be put on to the. It will be stored in the default system directory</p> <p>See example below.</p> <p><i>ftp</i>> put <source file> <destination>: source will be the filename only,.</p>

	<p>Destination will include both path and file name.</p> <p>Note: file on the ftp server might need to be deleted before it can be down with the same file name.</p> <p>ftp> mode <mode>: Default operation mode is Passive and can be configure as active with the mode option.</p> <p>ftp> logout: logout of the ftp session.</p> <p>Note: Please ensure that the FTP server is reachable by checking with ping command from debug prompt.</p> <p>.</p>
<p>EXAMPLE</p>	<pre>(CLI-eng)# ftp 10.14.0.85 trango Password: ftp>get zImage ##### Get operation successful with passive mode ftp>put linkloss.txt linkloss.txt ##### Put operation successful with passive mode ftp>logout (CLI-config)#</pre>

help / ?

<p>SYNTAX</p>	<p>?</p>
----------------------	----------

	<p>Default: N/A</p> <p>Configuration Storage: No</p> <p>? is a system-level command.</p>
DESCRIPTION	Typing the ? command will display the list of commands in the current node with a one line description of the commands
EXAMPLE	<p><i>(trango-config)#?</i></p> <p><i><Display the List of cmds></i></p>
RELATED	N/A

guard_time

SYNTAX	<p><i>guard_time</i></p> <p><i>guard_time <10-30> seconds</i></p> <p>Default: <i>15 seconds.</i></p> <p>Configuration Storage: Yes</p> <p><i>guard_time</i> without any parameter will display the current guard time value in seconds.</p>
DESCRIPTION	Guard time is only valid with failover feature enabled. Whenever a switchover has occurred, the guard time will be started and within the

	guard time period, no additional switchover is allowed.
--	---

httpd

SYNTAX	<p><i>httpd</i></p> <p><i>httpd</i> <on off></p> <p>Default: <i>httpd ON</i>.</p> <p>Configuration Storage: Yes</p> <p><i>httpd</i> without any parameter will display the current status for the web interface daemon</p> <p><i>httpd</i> is a system-level command.</p>
DESCRIPTION	<p>Turn on httpd server for web interface access.</p> <p>The web interface supports both secure (https) and normal (http) access.</p>

ibm

SYNTAX	<p><i>ibm</i></p> <p><i>ibm enable</i> < on off ></p> <p><i>ibm ip</i> <ip_addr> <netmask></p> <p><i>ibm port</i> <1-4: ge1-ge4></p>
---------------	--

	<p><i>ibm vlanid <1-4088></i></p> <p>Default: enable=OFF, ip=172.16.10.0, netmask=255.255.0.0, vlanid=100.</p> <p>Configuration Storage: Yes</p> <p><i>ibm</i> without any parameter will display the current IBM features parameters.</p>
DESCRIPTION	<p><i>ibm</i> is used to configure the In Band Management (IBM) channel to manage the system.</p> <p>Both IBM and the Out of Band Management (OBM) can be used together. The management VLAN ID can be configured based on the user requirement from 1-4090. The IP address for the IBM channel is independent of the OBM port on the IDU. The 2 IP addresses need to be unique.</p>

ipconfig

SYNTAX	<p><i>ipconfig</i></p> <p><i>ipconfig ip [ip_addr] [netmask]</i></p> <p><i>ipconfig gateway [default_gateway_ip]</i></p> <p>Default: IP=192.168.100.100, NETMASK=255.255.255.0, GATEWAY=192.168.100.100</p> <p>Configuration Storage: Yes</p> <p><i>ipconfig</i> without any parameter will display the current IP configuration</p>
---------------	--

	<p>and remote IP address.</p> <p><i>ipconfig</i> is a system-level command.</p>
DESCRIPTION	<p>This command is used to set IP address, subnet mask and default gateway for the management port of the system. The system MAC address can be displayed via this command. The change takes place effect immediately.</p> <p><i>ipconfig ip:</i> Both IP and netmask parameters must be present.</p> <p><i>ipconfig gateway:</i> Configure the default gateway IP. Valid for both Inband and Out-of-band port.</p>

license

SYNTAX	<p><i>license</i> <i>Display license enable status</i></p> <p><i>license_speed</i> <1-2> <speedkey></p> <p><i>license_tdm</i> <tdm_key></p> <p>Default: N/A</p> <p>Configuration Storage: No</p>
DESCRIPTION	<p>License key command is used to set the license required for using higher speed (> 100Mbps) on the radio. Speed key 1 enables speed up to 200Mbps and speed key 2 enables Max speed. Please refer to the actual speed/modulation/channel width combination for valid profiles.</p>

	<p>The license key is specific to each unit (management port Ethernet MAC address) and is not transferable. The PDH key enables all T1/E1 ports on the IDU.</p> <p>Please refer to valid speed profiles.</p>
--	--

link_history

SYNTAX	<p><i>link_history</i></p> <p>Default: N/A</p> <p>Configuration Storage: No</p>
DESCRIPTION	<p>This command is to display if the link history and the link steady flag.</p> <p><i>Link history:</i> contains the number of link up/down occurred since the system bootup and this number does not get reset until the radio reboots.</p> <p><i>Link steady:</i> current status of link steady flag. Defined to be approximately 40 seconds after the link has been established.</p>

linktest

SYNTAX	<p><i>linktest</i> <iterations></p> <p>Iteration range from 1-99 seconds</p> <p>Default: default iteration = 1 second</p>
---------------	---

	<p>Configuration Storage: NO</p> <p><i>mse</i> without any parameter will display the current mse value for both Modem1 and Modem2</p>
DESCRIPTION	<p>Linktest command is used to test the current link status and can be used to monitor the link, based on the specified duration. CLI prompt will not be accessible while linktest is running</p> <p>The linktest shows the following in the output</p> <p>Lock: Radio Lock Status</p> <p> 1: if all modem locks are locked</p> <p> 0: if any lock indicator shows unlocked</p> <p>RSSI: The current RSSI value</p> <p>MSE: The current MSE value</p> <p>BER : The instantaneous BER value (1sec interval)</p>

loglevel

SYNTAX	<p>loglevel [0-2]</p> <p><0: Setting, 1: Event, 2: Status>Default: 2</p> <p>Configuration Storage: Yes</p>
---------------	--

DESCRIPTION	<p>loglevel is used to set the appropriate logging for the system.</p> <p>This command is used to set required log levels for system logging. The log level needs to be set for each activity to be monitored. Once the loglevels are set, the logs can be monitored through the “syslog” command</p>
--------------------	---

loopback

SYNTAX	<p><i>loopback</i></p> <p><i>loopback <off if dig ></i></p> <p><i>loopback_auto <1-99></i></p> <p>Default: OFF</p> <p>Configuration Storage: Yes</p> <p><i>loopback</i> without any parameter will display the current status</p>
DESCRIPTION	<p>Activates one of the loopback modes for test purposes. Must be turned off by a command. The CLI is still active while the mode is on to allow monitoring of various parameters.</p> <p><i>loopback off</i> is the normal link operational mode.</p> <p><i>loopback dig</i> loops data back at the modem before modulation onto the intermediate frequency (IF)</p> <p><i>loopback IF</i> loops the modulated signal at 350 MHz back to the RX IF frequency of 140 MHz and demodulates the signal in the modem.</p> <p><i>Loopback_auto</i> runs digital and IF loopbacks automatically for a specified number of iterations, then resets the link back to normal mode. This is very useful for remote radios which will break the link during the loopback and then return to normal mode to be managed again. This command will automaticall turn the Ethernet ports off as well and prevent a loop from occurring on the network.</p>

	<p>During IF and digital loopback, the transmitter signal from the far end will still be present at the input to the IDU and may cause a poor result. Therefore, the <i>odupower OFF</i> on the remote end of may be required to eliminate any signal from the far end which may corrupt the result.</p> <p>IMPORTANT: Make sure that the data ports are disabled before executing the <i>loopback if / dig</i> comands or a loop may be formed on the network.</p> <p>All loopback modes will stop live traffic from passing across the link</p>
--	--

model

SYNTAX	<p><i>model</i></p> <p>Default: N/A</p> <p>Configuration Storage: No</p>
DESCRIPTION	<p>Display current ODU/IDU model and serial ID.</p> <p>The following information are been displayed: ODU model, IDU model, ODU Serial ID, IF Rev, IF Serial, IDU Model, IDU Serial ID for each radio</p>

mse

SYNTAX	<i>Mse</i>
---------------	------------

	<p><i>mse <duration></i>: duration range from 1-99 seconds</p> <p>Default: default duration = 1 second</p> <p>Configuration Storage: NO</p> <p><i>mse</i> without any parameter will display the current mse value for the received signal.</p>
DESCRIPTION	<p><i>mse</i> command is used to monitor the Mean Square Error (MSE) of the link received signal based on the specified duration. CLI prompt will not be accessible while linktest is running.</p>

oduled

SYNTAX	<p><i>oduled</i></p> <p><i>oduled < on off ></i></p> <p>Default: ON</p> <p>Configuration Storage: YES</p> <p><i>oduled</i> without any parameter will display the current status of ODU LED display</p>
DESCRIPTION	<p>Turn ON/OFF ODU led for display RSSI value. Applies only to SP ODUs</p>

odupower

<p>SYNTAX</p>	<p><i>odupower</i></p> <p><i>odupower < on/ off ></i></p> <p>Default: OFF</p> <p>Configuration Storage: Yes</p> <p><i>odupower</i> without any parameter will display the current status of ODU power .</p>
<p>DESCRIPTION</p>	<p>The command is used to Turn ON/OFF odupower.</p> <p>The ODU is powered from the IDU over the IF cable with -48VDC</p> <p>It is recommended to turn off the ODU power during initial installing of the ODU on the tower and other maintenance</p> <p>The response time for ODU power ON will vary depending upon the ODU model. It is longer for HP ODUs</p>

odurxagc

<p>SYNTAX</p>	<p><i>odurxagc <on off></i></p>
<p>DEFAULT VALUE</p>	<p>Off</p>
<p>DESCRIPTION</p>	<p>The command is used to set the odurx gain control loop in the system. This controls the receive level into the IDU from the ODU and keeps the received level within a predefined range. This helps to improve MSE and maintain better system performance in fading conditions.</p>

	Applicable only for SP ODU [6,11,11E,18,18E Model]
EXAMPLE	<p>To turn ON/OFF odurxagc loop</p> <pre>(trango-config)# odurxagc on</pre> <p>ODU Rx AGC: on</p> <p>SUCCESS</p> <p>To view current odurxagc status:</p> <pre>(trango-config)# odurxagc</pre> <p>ODU Rx AGC: off</p>
RELATED	targetrssi, cableloss

opmode

SYNTAX	<p><i>opmode</i></p> <p><i>opmode</i> < on off ></p> <p>Default: OFF</p> <p>Configuration Storage: NO</p> <p><i>opmode</i> without any parameter will display the current status of ODU operation mode</p>
---------------	--

DESCRIPTION	<p>Opmode command is used to enable the transmitter on the ODU. Opmode settings are not persistent across reboot. See <code>default_opmode</code> command</p> <p><i>freq</i> and <i>speed</i> settings are required to be set to valid value before opmode can be turned ON.</p>
--------------------	---

passwd

SYNTAX	<p><i>Passwd</i> <new_password> <confirm_password></p> <p>Default: <i>N/A</i>. Default config node <i>passwd</i> is <i>trango</i></p> <p>Configuration Storage: Yes</p> <p><i>passwd</i> is a system-level command.</p> <p><new_password> must be at least 4 characters and no more than 10 characters</p> <p><new_password> and <confirm_password> must be identical for the new password to take effect</p>
DESCRIPTION	<p>Update the current password for entering “config-node”. The new password takes effect only after a <i>reboot</i> command or re-enter the “view-node” from debug prompt with <i>cli</i> command.</p>

port

<p>SYNTAX</p>	<pre>port eth <1-4> auto_negotiate <on off> port eth <1-4> dscp_source <1-63> <0-7> port eth <1-4> duplex <half full> port eth <1-4> enable <on off> port eth <1-4> maxrate <0-1000> port eth <1-4> pause <on off> port eth <1-4> priority <0-7> port eth <1-4> speed <0-1000></pre>
<p>DESCRIPTION</p>	<p>This command is used to individually set Ethernet port settings for auto negotiation, dscp_source mapping, port enable/disable, speed, priority, pause frame, duplex and max rate.</p> <p><i>auto_negotiate</i> must be enabled for Gigabit operation (default). For hard setting of the speed to 100 Mbps or 10 Mbps, autonegotiate must be turned off.</p> <p><i>dscp_source</i> is used to assign the DSCP field (0-63) in the IP packet to a priority (0-7) and mirrors the web command.</p> <p><i>maxrate</i> will limit the incoming traffic on the port to the number set, in Mbps.</p> <p><i>pause</i> will enable pause frames to be sent upon buffer full conditions and only applies for Gigabit Ethernet operation.</p> <p><i>priority</i> will assign a priority to the internal tag used for smart mode to condition traffic coming into the port that is untagged. This allows some traffic shaping simply based on the port that the traffic is entering. If tagged traffic comes into the port, the port priority setting will override the COS field in the tagged traffic.</p> <p>Note: <i>speed/duplex/auto Negotiate</i> is fixed for ge3/ge4 which are GigE Fiber ports and these setting are not configurable</p>

power

<p>SYNTAX</p>	<p><i>power</i></p> <p><i>power < 0-30 ></i></p> <p>Default: 10 dBm</p> <p>Configuration Storage: Yes</p> <p><i>opmode</i> without any parameter will display the current status of ODU transmit power level</p>																																	
<p>DESCRIPTION</p>	<p>Power command is used to set the ODU transmit power level. The maximum level is dependent upon the modulation and ODU model.</p> <p>Ensure that the power does not exceed the rating for the modulation being used or signal distortion will occur. SP ODU levels are shown here for reference.</p> <table border="1" data-bbox="500 1310 1385 1869"> <thead> <tr> <th>SP ODU Model</th> <th>Modulation</th> <th>Max Tx power</th> </tr> </thead> <tbody> <tr> <td rowspan="3">18, 18E</td> <td>QAM256</td> <td>17</td> </tr> <tr> <td>QAM128</td> <td>18</td> </tr> <tr> <td>QAM64</td> <td>19</td> </tr> <tr> <td rowspan="4">6, 6E, 11, 11E</td> <td>QAM256</td> <td>19</td> </tr> <tr> <td>QAM128</td> <td>20</td> </tr> <tr> <td>QAM64</td> <td>21</td> </tr> <tr> <td>QAM32</td> <td>22</td> </tr> <tr> <td rowspan="3">23, 23E</td> <td>QAM256</td> <td>17</td> </tr> <tr> <td>QAM16</td> <td>19</td> </tr> <tr> <td>QPSK</td> <td>20</td> </tr> <tr> <td rowspan="3">15E</td> <td>QPSK</td> <td>23</td> </tr> <tr> <td>QAM16</td> <td>22</td> </tr> <tr> <td>QAM64</td> <td>21</td> </tr> </tbody> </table>	SP ODU Model	Modulation	Max Tx power	18, 18E	QAM256	17	QAM128	18	QAM64	19	6, 6E, 11, 11E	QAM256	19	QAM128	20	QAM64	21	QAM32	22	23, 23E	QAM256	17	QAM16	19	QPSK	20	15E	QPSK	23	QAM16	22	QAM64	21
SP ODU Model	Modulation	Max Tx power																																
18, 18E	QAM256	17																																
	QAM128	18																																
	QAM64	19																																
6, 6E, 11, 11E	QAM256	19																																
	QAM128	20																																
	QAM64	21																																
	QAM32	22																																
23, 23E	QAM256	17																																
	QAM16	19																																
	QPSK	20																																
15E	QPSK	23																																
	QAM16	22																																
	QAM64	21																																

		QAM128	20
	The user cannot change power when ATPC is ON.		

prompt

SYNTAX	<p><i>prompt <prompt_str></i></p> <p>Default: CLI</p> <p>Configuration Storage: Yes</p> <p><i>prompt</i> is a system-level command.</p>
DESCRIPTION	<p>Prompt command is used to update the CLI prompt with more descriptive name of the system. Default prompts are <CLI-view>, <CLI-config>. The user may update to a string that is more meaningful.</p>

qos

SYNTAX	<p><i>qos</i></p> <p><i>qos <priority(0-7)> <queue(0-7)></i></p> <p><i>qos dscp_weight <priority(0-7)> <weight(1-15)></i></p> <p><i>qos mode <0/1></i></p>
---------------	--

qos_info <1-4>

Default:

Priority 0	COS Queue = 0
Priority 1	COS Queue = 1
Priority 2	COS Queue = 2
Priority 3	COS Queue = 3
Priority 4	COS Queue = 4
Priority 5	COS Queue = 5
Priority 6	COS Queue = 6
Priority 7	COS Queue = 7

Configuration Storage: YES

qos is a system-level command.

.

DESCRIPTION

qos <priority> <queue> is used to map the priority field in the VLAN COS field of the incoming packet to one of the 8 queues based on the packet priority per 802.1p. The traffic class of the incoming packet is mapped 1to1 to the 8 priorities as default.

qos dscp_weight <priority> <queue> is used to map weights to priority levels for the Weighted Round Robin (WRR) qos mode used with 802.1p Layer 2 **AND** Diffserv (Layer 3 DSCP) DSCP bits in the incoming IP packets.

For Diffserv, the DSCP bits are mapped to a priority, which is in turn mapped to a queue. Individual DSCP field to priority mappings must be done using the web interface.

qos mode <0/1> sets the qos mode to either strict or WRR. (0=strict and 1=WRR).

For strict mode, the scheduling in strict priority as follows

COSQ7> COSQ6 > COSQ5 > COSQ4> COSQ3 > COSQ2 > COSQ1 > COSQ0

This means that all packets in COSQ7 will be forwarded (Queue must be empty) before any packets in the lower priority queues are forwarded, and so on down to COSQ0.

For WRR mode, weights are put on the priorities, which are mapped

directly to queues. In this mode, the proportion of time spent forwarding the packets from each queue is proportional to the weight given to the queue.

For example, If all queues are given a weight of 1, then there will be no preferential treatment given to any one queue. If one queue is subsequently given a value of 8, then that queue be emptied 8 times more often than the queues with weight of 1.

This method allows **some** packets to go through from all queues but not all high priority queue packets can be guaranteed to go through in the event of saturation of the link capacity.

qos_info x displays the current DSCP mapping of DSCP field to priority for Ethernet port x

EXAMPLE:

```
(CLI-config)# qos 2 3
```

```
qos map priority=2, queue=3
```

```
SUCCESS
```

```
(CLI-config)# qos
```

```
COS scheduling:      strict
Priority 0:          COS Queue = 0
Priority 1:          COS Queue = 1
Priority 2:          COS Queue = 3
Priority 3:          COS Queue = 3
Priority 4:          COS Queue = 4
Priority 5:          COS Queue = 5
Priority 6:          COS Queue = 6
Priority 7:          COS Queue = 7
```

reboot

SYNTAX	<i>reboot</i> Default: N/A
---------------	-----------------------------------

	Configuration Storage: No <i>reboot</i> is a system-level command.
DESCRIPTION	Reboots entire system including datapath. No configuration changes after the system reboot.

reload

SYNTAX	<i>reload</i> <1-99> <i>reload cancel</i> Default: N/A Configuration Storage: No <i>reload</i> is a system-level command.
DESCRIPTION	Reboots and reloads entire system in a specified time in minutes. Allows user to make changes to a remote unit and prevent loss of connection in the event the link is broken. Previously saved configuration will be loaded upon reboot. Reload cancel cancels the scheduled reload/reboot ..

remark

SYNTAX	<i>remark</i> <i>remark [system_remark]</i> Default: Remark=Trango GigPlus
---------------	--

	Configuration Storage: Yes
DESCRIPTION	<p>Remark of the system typically used for identification purposes.</p> <p>Device string is used to display the device name on the top of the row for all the device-level parameters.</p>

reset

SYNTAX	<p><i>reset config</i></p> <p><i>reset ipconfig</i></p> <p><i>reset license_key</i></p> <p>Default: N/A</p> <p>Configuration Storage: No</p> <p><i>reset</i> is a system-level command.</p>
DESCRIPTION	<p><i>reset config</i>: Restore all factory default configuration setting including resetting password for system login, CLI config node, Web interface login. Excluding license key and IP configuration.</p> <p>A reboot of the system is required for the command to take effect.</p> <p><i>reset ipconfig</i>: Reset only the IP configuration to default.</p>

	<i>reset license_key</i> : Remove up to 5 license keys.
--	---

rps

SYNTAX	<p><i>rps</i> < on off ></p> <p>Default: OFF</p> <p>Configuration Storage: Yes</p> <p><i>rps</i> without any parameter will display the current status of Rapid Port Shutdown feature status.</p>
DESCRIPTION	<p>This command is used to configure Rapid Port Shutdown (RPS) functionality. The RPS setting needs to be the same on both side of the link for proper operation.</p> <p>If the RPS is enabled the dataports (GigE) on both side of the link are immediately shutdown in the event of a link loss in order to provide a fast switchover mechanism to the external routers and switches.</p>
RELATED	Sysinfo

rss

SYNTAX	<p><i>rss</i> <iteration></p> <p>Iteration range from 1-99 seconds</p> <p>Default: default iteration = 1 second</p> <p>Configuration Storage: NO</p> <p><i>rss</i> without any parameter will display the current mse value</p>
DESCRIPTION	<p><i>rss</i> command is used to monitor the received signal level. It is used to monitor the link, based on the specified duration. CLI prompt will not be accessible while <i>rss</i> command is running.</p> <p>RSSI value range should be between -90 and -30</p> <p>For some SP ODUs, the RSSI value will not display below -65 dBm accurately, so for antenna alignment purposes the MSE can be used as a guide until the signal is acquired. See the Antenna Alignment Section for more information</p>

siglevel

SYNTAX	<p><i>siglevel</i></p> <p>Default: N/Q</p> <p>Configuration Storage: No</p> <p><i>Siglevel</i> will display the signal level related parameter for modem 1</p>
DESCRIPTION	<p>This command is used to assist debugging any signal path related issue.</p> <p>IDU RSSI: idu rssi on the modem level.</p> <p>Nomralize MSE/Radial MSE: Norm-MSE = Radial MSE phase noise residue is minimal</p>

	<p>Norm-MSE > Radial MSE there is some amplitude noise (AM distortion)</p> <p>Norm-MSE < Radial MSE phase noise residue exist, that the PLL did not fully correct</p> <p>Uncorrect Block: Error reported by modem when passing traffics.</p> <p>Power sensors: used to make sure TX power accuracy. Some models uses only IF while other using only the RF values.</p> <p>Odu attn: Make sure the attenuators are been set correctly.</p> <p>Note: Block counter & uncorrect block counter are accumulative values since the last link establishment. They are collected on a 20 second periodic basis.</p>
<p>EXAMPLE</p>	<pre>(CLI-view)# siglevel IDU RSSI: 0 Normalized MSE: -348 Radial MSE: -340 LDPC Decoder Stress: 0 External AGC: 1604 Carrier Offset: 2466 Rx Symrate: 49500732 Block Counter: 0 Uncorrect Block: 0 LDPC Avg Iteration: 0 Output corrected bytes: 0 Return Loss: 0x0000 Tx Power alarm: ok Tx PA alarm: ok PA on/off alarm: on Tx Power Range alarm: ok Tx Power actual: 20.00 Rx Power actual: -23.00 Channel test: Pass Telemetry debug: Fail (CLI-view)#</pre>

snmpd

SYNTAX	<p><i>snmpd</i></p> <p><i>snmpd <on off></i></p> <p>Default: <i>ON</i></p> <p>Configuration Storage: No. Always ON at system bootup.</p> <p><i>snmpd</i> without any parameter will display the current status for the tftpd daemon</p>
DESCRIPTION	Turn on/off snmpd agent on the radio. Must be on to perform any SNMP get/set.
EXAMPLE	<p>To turn snmpd off</p> <p><i>(trango-config)# snmpd off</i></p> <p><i>snmpd: off</i></p> <p><i>SUCCESS</i></p>
RELATED	Ipconfig, snmptrap, trapip

speed

<p>SYNTAX</p>	<p><i>speed</i> <bandwidth> <modulation></p> <p><bandwidth>: 4,5,7,8,10,12,14,20,25,28,30,40,50,56,80</p> <p><modulation>: qpsk, qam16, qam32, qam64, qam128, qam256</p> <p>Default: bandwidth 30, QAM32</p> <p>Configuration Storage: Yes</p> <p><i>speed</i> without any parameter will display the current speed setting</p>					
<p>DESCRIPTION</p>	<p>Load the corresponding the modem binary and configure Tx and Rx bandpass filters.</p> <p>The <i>speed</i> command will also configure the modem protection mode based on the <i>system_mode</i> configuration. Only when the 1+1 HSB mode is set, the modem may be configured as working or protection mode.</p> <p>Binaries selection for the speed command is based on 5 different configuration: <i>tdm_mode</i>, <i>acm enable</i>, modulation and bandwidth.</p> <p>Making changes via the <i>tdm_mode</i>, or <i>acm enable</i> commands will require a subsequent re-load of the speed setting for proper operation.</p>					
<p>Speed Setting (Actual BW)</p>	<p>Modulation</p>	<p>IF RX LPF (MHz)</p>	<p>IF TX LPF (MHz)</p>	<p>Total Capacity</p>	<p>Symbol Rate</p>	<p>License key</p>

4 (3.75 MHz)	QPSK	9.375	22	6	3.0	None
5	QPSK	9.375	22	8	4.30	None
7	QPSK	9.375	22	10	5.6	None
8 (8.33 MHz)	QPSK	9.375	22	13	7.2	None
10	QPSK	18.75	22	15	8.32	None
12 (12.5 MHz)	QPSK	18.75	22	20	10.8	None
14	QPSK	18.75	22	22	12.20	None
20	QPSK	30	38	31	17.42	None
25	QPSK	30	38	39	21.8	None
28	QPSK	30	38	47	26	None
30	QPSK	50	39	47	26	None
40	QPSK	50	66	63	35.42	None
50	QPSK	75	56	78	43	None
56	QPSK	75	56	90	49.50	None
80	QPSK	75	56	90	49.50	None
4 (3.75 MHz)	16QAM	9.375	22	9	3.75	None
5	16QAM	9.375	22	12	4.30	None
7	16QAM	9.375	22	20	5.6	None
8	16QAM	9.375	22	26	7.2	None
10	16QAM	18.75	22	30	8.32	None
12	16QAM	18.75	22	40	10.8	None
14	16QAM	18.75	22	45	12.20	None
20	16QAM	30	38	63	17.42	None
25	16QAM	30	38	80	21.8	None
28	16QAM	30	38	95	26	None
30	16QAM	50	39	95	26	None
40	16QAM	50	66	128	35.42	Key-1
50	16QAM	75	66	157	43	Key-1
56	16QAM	75	66	181	49.50	Key-1

80	16QAM	75	66	181	49.50	Key-1
4 (3.75 MHz)	32QAM	9.375	22	15	3.0	None
5	32QAM	9.375	22	19	4.30	None
7	32QAM	9.375	22	25	5.6	None
8	32QAM	9.375	22	33	7.2	None
10	32QAM	18.75	22	37	8.32	None
12	32QAM	18.75	22	49	10.8	None
14	32QAM	18.75	22	55	12.20	None
20	32QAM	30	38	78	17.42	None
25	32QAM	30	38	99	21.8	None
28	32QAM	30	38	118	26	None
30	32QAM	50	39	118	26	None
40	32QAM	50	66	159	35.42	Key-1
50	32QAM	75	66	195	43	Key-1
56	32QAM	75	66	225	49.50	Key-2
80	32QAM	75	66	225	49.50	Key-2
4 (3.75 MHz)	64QAM	9.375	22	18	3.0	None
5	64QAM	9.375	22	24	4.30	None
7	64QAM	9.375	22	31	5.6	None
8	64QAM	9.375	22	40	7.2	None
10	64QAM	18.75	22	46	8.32	None
12	64QAM	18.75	22	60	10.8	None
14	64QAM	18.75	22	67	12.20	None
20	64QAM	30	38	96	17.42	None
25	64QAM	30	38	120	21.8	Key-1
28	64QAM	30	38	142	26	Key-1
30	64QAM	50	39	142	26	Key-1
40	64QAM	50	66	192	35.42	Key-1
50	64QAM	75	66	238	43	Key-2

56	64QAM	75	66	275	49.50	Key-2
80	64QAM	75	66	275	49.50	Key-2
4 (3.75 MHz)	128QAM	9.375	22	21	3.0	None
5	128QAM	9.375	22	27	3.40	None
7	128QAM	9.375	22	36	5.6	None
8	128QAM	9.375	22	46	7.2	None
10	128QAM	18.75	22	53	8.32	None
12	128QAM	18.75	22	70	10.8	None
14	128QAM	18.75	22	78	12.20	None
20	128QAM	30	38	111	17.42	None
25	128QAM	30	38	140	21.8	Key-1
28	128QAM	30	38	167	26	Key-1
30	128QAM	50	39	167	26	Key-1
40	128QAM	50	66	225	35.42	Key-2
50	128QAM	75	66	277	43	Key-2
56	128QAM	75	66	320	49.50	Key-2
80	128QAM	75	66	320	49.50	Key-2
4 (3.75 MHz)	256QAM	9.375	22	23	3.0	None
5	256QAM	9.375	22	31	4.30	None
7	256QAM	9.375	22	40	5.6	None
8	256QAM	9.375	22	52	7.2	None
10	256QAM	18.75	22	60	8.32	None
12	256QAM	18.75	22	78	10.8	None
14	256QAM	18.75	22	88	12.20	None
20	256QAM	30	38	126	17.42	Key-1
25	256QAM	30	38	160	21.8	Key-1
28	256QAM	30	38	192	26	Key-1
30	256QAM	50	39	192	26	Key-1
40	256QAM	50	66	256	35.42	Key-2

50	256QAM	75	66	318	43	Key-2
56	256QAM	75	66	365	49.50	Key-2
80	256QAM	75	66	375	49.50	Key-2

status

<p>SYNTAX</p>	<p><i>status modem</i></p> <p><i>status pll</i></p> <p><i>status port</i></p> <p><i>status tdm</i></p> <p><i>status clear</i></p> <p>Default: N/A</p> <p>Configuration Storage: No</p> <p><i>status</i> is a system-level command.</p>
<p>DESCRIPTION</p>	<p><i>Status modem:</i> display modem link status. MSE, RSSI, BER, FER</p> <p><i>Status pll:</i> display ODU / IDU pll lock status.</p> <p><i>Status port:</i> display Ethernet counters for each ports, RF counters and port utilizations.</p> <p><i>status tdm:</i> display T1/E1 counters and error status</p> <p><i>status clear:</i> clear all Ethernet, RF, TDM counters and port</p>

	utilization.
--	--------------

sync

SYNTAX	<p><i>sync</i></p> <p>Default: N/A Configuration Storage: N/A</p> <p><i>sync</i> without any parameter will perform synchronization procedure between Active and Standby unit</p> <p><i>sync</i> command only allowed to be initiated on Active unit.</p>
DESCRIPTION	<p><i>sync</i> is used to perform synchronization procedure to sync up configuration parameters between Active and Standby units. There are some parameters which are independent of utype and therefore, will not be synchronized with this command. The following commands are the ones that, if executed, prevent achieving sync with the Standby unit:</p> <p>Alarm, alignment, cableloss, fanctrl, ibm, ipconfig, license key, loopback mode, opmode, tftpd and traps.</p>

sync_state

SYNTAX	<p><i>sync_state</i></p> <p>Default: N/A Configuration Storage: N/A</p> <p><i>sync_state</i> without any parameter will display synchronization status</p>
---------------	--

DESCRIPTION	<p><i>sync_state</i> is used to display the current synchronization status between Active and Standby unit.</p> <p>The following parameters will not be synchronized.</p> <p>Alarm, alignment, cableloss, fanctrl, ibm, ipconfig, license key, loopback mode, opmode, tftpd and traps</p>
--------------------	---

sysinfo

SYNTAX	<p><i>sysinfo</i></p> <p><i>sysinfo</i> <0-6></p> <p>Default: N/A</p> <p>Configuration Storage: No</p> <p><i>sysinfo</i> without any parameter will display the current IDU and ODU configuration parameters.</p> <p><i>sysinfo</i> takes a parameter for information category: 0=version info, 1=Management, 2=Radio Config, 3= System Config , 4=Ethernet 5=ACM, 6=threshold settings</p> <p><i>sysinfo</i> is a system-level command.</p>
DESCRIPTION	<p>View the current configuration status of the local side IDU and ODU. To select a subset of the entire system info, add the argument 0 through 6 after the <i>sysinfo</i> command</p>

syslog

SYNTAX	<p><i>syslog</i></p> <p><i>syslog [0-2]</i></p> <p><i>syslog clear</i></p> <p><i>syslog export</i></p> <p>Default: 0: SET, 1: EVENT</p> <p>Configuration Storage: Yes</p> <p><i>syslog</i> without any parameter will display all the system log message for up to 3000 lines.</p> <p><i>syslog</i> takes a parameter for log level: 0=SET, 1=EVENT, 2=STAT</p> <p><i>syslog export</i>, export the syslog to a syslog.txt file which can be tftp by customer.</p> <p><i>syslog</i> is a system-level command.</p>
DESCRIPTION	<p><i>syslog</i>: will display all the system log entries that have been recorded since the boot up.</p> <p><i>syslog clear</i>: Clear all syslog. Only 3000 log entries will be captured and will wrap around when overflows.</p>

targetrssi

SYNTAX	<i>targetrssi</i> <i>targetrssi < -30 - 80 ></i> Default: -40 Configuration Storage: YES <i>targetrssi</i> without any parameter will display the <i>targetrssi</i> of the ODU
DESCRIPTION	Configure the target RSSI level that the ATPC and ODU gain control will try to maintain. The number should be 2-3 dB below the expected RSSI based on path calculations.

tdm

SYNTAX	<i>tdm</i> Default: N/A Configuration Storage: No
DESCRIPTION	Display TDM port mode and coding For E1: HDB3 For T1: AMI or B8ZS
EXAMPLE	(CLI-config)# <i>tdm</i> TDM Mode: ETH only TDM Coding: HDB3

--	--

telnetd

SYNTAX	<p><i>telnetd</i></p> <p><i>telnetd</i> <on off></p> <p>Default: <i>telnetd</i> OFF.</p> <p>Configuration Storage: Yes</p> <p><i>telnetd</i> without any parameter will display the current status for the telnetd daemon</p> <p><i>telnetd</i> is a system-level command.</p>
DESCRIPTION	Linux system command to start the telnetd daemon

temp

SYNTAX	<p><i>temp</i></p> <p>Default: N/A</p> <p>Configuration Storage: No</p>
---------------	---

	<p><i>temp</i> without any parameter will display the current IDU and ODU temperatures.</p> <p><i>temp</i> is a system-level command.</p>
DESCRIPTION	<p>View the current temperatures of IDU and ODU. The temperature reported is the temperature inside the unit in degrees Celcius.</p> <p>For ODUs, the outside temperature is typically 20 degrees less than the temperature that is read from the unit. For a 55 degree C outside temp, the ODU would read approximately 75 deg. If thresholds are used to trap events, ensure that this is taken into consideration.</p>

tftpd

SYNTAX	<p><i>tftpd</i></p> <p><i>tftpd</i> <on off></p> <p>Default: <i>tftpd</i> OFF.</p> <p>Configuration Storage: Yes</p> <p><i>tftpd</i> without any parameter will display the current status for the tftpd daemon</p> <p><i>tftpd</i> is a system-level command.</p>
DESCRIPTION	<p>Turn on the tftp server. Used to transfer diagnostic file, configuration file and software images during upgrades.</p>

threshold

SYNTAX	<p><i>threshold action</i> <0-8> <0-5></p> <p><i>threshold value</i> <0-7> <-100 to 100></p> <p>Defaults: see the table below.</p> <table border="1" data-bbox="522 760 1289 1428"><thead><tr><th>parameters</th><th>min</th><th>max</th><th>Action</th></tr></thead><tbody><tr><td>RSSI</td><td>-85</td><td>-20</td><td>none</td></tr><tr><td>MSE</td><td>-45</td><td>-15</td><td>none</td></tr><tr><td>BER</td><td>0.00E+0</td><td>1.00E-4</td><td>none</td></tr><tr><td>BER</td><td>0.00E+0</td><td>1.00E-4</td><td>none</td></tr><tr><td>IDU temp</td><td>-10</td><td>55</td><td>none</td></tr><tr><td>ODU temp</td><td>-40</td><td>58</td><td>none</td></tr><tr><td>In port util</td><td>0.0</td><td>100.0</td><td>none</td></tr><tr><td>Out port util</td><td>0.0</td><td>100.0</td><td>none</td></tr><tr><td>Link Down</td><td>N/A</td><td>N/A</td><td>none</td></tr></tbody></table> <p>Configuration Storage: Yes</p> <p><i>threshold</i> without any parameter will display the current status for threshold setting information</p> <p><i>threshold</i> is a device-level command.</p>	parameters	min	max	Action	RSSI	-85	-20	none	MSE	-45	-15	none	BER	0.00E+0	1.00E-4	none	BER	0.00E+0	1.00E-4	none	IDU temp	-10	55	none	ODU temp	-40	58	none	In port util	0.0	100.0	none	Out port util	0.0	100.0	none	Link Down	N/A	N/A	none
parameters	min	max	Action																																						
RSSI	-85	-20	none																																						
MSE	-45	-15	none																																						
BER	0.00E+0	1.00E-4	none																																						
BER	0.00E+0	1.00E-4	none																																						
IDU temp	-10	55	none																																						
ODU temp	-40	58	none																																						
In port util	0.0	100.0	none																																						
Out port util	0.0	100.0	none																																						
Link Down	N/A	N/A	none																																						
DESCRIPTION	<p><i>threshold</i> command is used to set rules for monitoring the system.</p>																																								

	<p><i>threshold value</i> allows the user to set a threshold for the following parameters between a value of -100 and 100.</p> <p>Parameters</p> <ul style="list-style-type: none"> 0- RSSI 1- MSE 2- BER 3- FER 4- IDU_temp 5- ODU_temp 6- In port utilization 7- Out port utilization <p><i>threshold action</i> allow specific action to be taken if the threshold set in threshold value is exceeded. Actions are:</p> <ul style="list-style-type: none"> 0- No action 1- Alarm1 on front panel closure 2- Alarm2 on front panel closure 3- SNMP trap 4- Switchover to standby unit 5- Rapid Port Shutdown (RPS) <p>The utilization rate is expressed as percentage of the current max speed based on the modulation.</p>

trap

<p>SYNTAX</p>	<p><i>trap</i></p> <p><i>trap enable</i> <trap #> <on off></p> <p><i>trap ip</i> <trap #> <ip_addr></p> <p>Default: see table 6.5</p>
----------------------	---

	<table border="1" data-bbox="548 258 1242 657"> <thead> <tr> <th>trap #</th> <th>IP</th> <th>enable</th> </tr> </thead> <tbody> <tr> <td>Trap 1 manager</td> <td>0.0.0.0</td> <td>OFF</td> </tr> <tr> <td>Trap 2 manager</td> <td>0.0.0.0</td> <td>OFF</td> </tr> <tr> <td>Trap 3 manager</td> <td>0.0.0.0</td> <td>OFF</td> </tr> <tr> <td>Trap 4 manager</td> <td>0.0.0.0</td> <td>OFF</td> </tr> <tr> <td>Trap 5 manager</td> <td>0.0.0.0</td> <td>OFF</td> </tr> </tbody> </table> <p>Configuration Storage: Yes</p> <p><i>trap</i> without any parameter will display the current status for the snmptrap information</p> <p><i>trap</i> is a system-level command.</p>	trap #	IP	enable	Trap 1 manager	0.0.0.0	OFF	Trap 2 manager	0.0.0.0	OFF	Trap 3 manager	0.0.0.0	OFF	Trap 4 manager	0.0.0.0	OFF	Trap 5 manager	0.0.0.0	OFF
trap #	IP	enable																	
Trap 1 manager	0.0.0.0	OFF																	
Trap 2 manager	0.0.0.0	OFF																	
Trap 3 manager	0.0.0.0	OFF																	
Trap 4 manager	0.0.0.0	OFF																	
Trap 5 manager	0.0.0.0	OFF																	
DESCRIPTION	<i>trap</i> is used to enable and configure traps and the IP address which they will be sent to																		

uptime

SYNTAX	Uptime
DEFAULT VALUE	N/A
DESCRIPTION	<p>Uptime is used to display how long the system has been running, since the last reboot/power cycle.</p> <p>It shows the current time and uptime.</p>

EXAMPLE	To display current uptime <i>(trango-config)# uptime</i> <i>20:45:58 up 1:49, load average</i>
RELATED	Date

utype

SYNTAX	<p><i>utype</i></p> <p>Default: N/A</p> <p>Configuration Storage: N/A</p> <p><i>utype</i> without any parameter will display current utype and other related status.</p>
DESCRIPTION	<p><i>Utype</i> command will display unit's current utype, remote unit status, election period status and sync status.</p> <p><u>Current utype</u>: No utype, Active, or Standby</p> <p><u>Protection</u>: Indicated if HW swiching protection is ON/OFF, dependent upon the standby link status and guard time protection.</p> <p><u>Remote unit status</u>: no detection, Standby detected, active detected</p> <p><u>Sync Status</u>: Current configuration synchronization status. Synchronized or Not synchronized.</p> <p><u>Guard Time</u>: Currently user configured guard interval.</p>

	<p><u>Failover Counter</u>: # of times the units have switched roles from active to standby and vice-a-versa</p> <p><u>Election Period</u>: yes (during election period), no (not in election period)</p> <p><u>Debug Reg</u>: For debugging</p>
EXAMPLE	<pre>(CLI-config)# utype Current utype: active Protection: off Redundancy Cable: connected Remote Unit Status: standby detected Sync Status: Synchronized Guard Time: 15 seconds Failover Counter: 0 Election Period: no Debug Reg: (D6)0x00, (D5)0x00, (24)0x1F</pre>

utype_switch

SYNTAX	<p><i>utype_switch</i></p> <p>Default: N/A Configuration Storage: N/A</p> <p><i>utype_switch</i> does not take any input parameter. Will perform utype switch from Active to Standby.</p> <p>This command only allowed on the Active unit. Can NOT be initiated on Standby unit</p>
DESCRIPTION	<p><i>utype_switch</i> manually switch the Active to the Standby unit by sending Switchover REQ to the standby unit.</p> <p>This command is mainly used for image upgrades. During the image upgrades, the standby unit can upgrade first and when done, perform</p>

	utype_switchover to make the current Active unit Standby to continue the upgrade process.
EXAMPLE	<pre>(CLI-config)# utype Current utype: active Remote unit status: detecting a standby Election Period: no Sync Status: Synchronized</pre>

version

SYNTAX	Version
DEFAULT VALUE	N/A
DESCRIPTION	Version command is used to display the current /previous software images on the radio. The system is capable of have multiple images.
RELATED	bootimage

voltage

SYNTAX	<pre>voltage</pre> <p>Default: N/A</p> <p>Configuration Storage: No</p>
---------------	---

	<p><i>voltage</i> without any parameter will display the current status for the IDU power voltage at different source</p> <p><i>voltage</i> is a system-level command.</p>
DESCRIPTION	<p>Query the voltage level at different power source on IDU. The following power source are being look at:</p> <p>V1.25:</p> <p>V2.5:</p> <p>V3.3:</p> <p>V5.0:</p> <p>V12.0:</p>

Appendix B – Product Specifications

Dimensions and Weight

Parameter	Specification
Size	IDU: 1.75 x 8.75 x 11.25 in HP ODU: 10.5 x 10.5 x 3.5 in HP1 ODU: 9.5 x 11.6 x 3.64 in HP2 ODU: 10.9 x 9.4 x 3.6 in
Weight	IDU: 4.8 lbs/2.18 kg HP ODU : 10.1 lbs/4.59 kg HP1 ODU : 8.6 lbs/3.9 kg HP2 ODU: 9.5 lbs/4.32 kg

Environmental

Parameter	Specification
Operating Temperature Range	IDU: -5 deg C to +55 deg C ODU: -40 deg C to +65 deg C - Functional ODU: -40 deg C to +55 deg C - Spec Compliant
Storage Temperature	-40 deg C to +75 deg C
Humidity	IDU : 95% Non condensing ODU: 100% Condensing
Water resistance	IDU: NA ODU:IP65 per EN 60529
Salt-Spray	IDU: NA ODU: ETS 300 019-2-4 Class 4M5

Emissions

Parameter	Specification
ETSI Conducted Emissions	EN 55022 (2006) Class "A"
FCC Conducted Emissions	FCC 15.107 (a) Class "A"

ETSI Radiated Emissions	EN 55022 (2006) Class "A"
FCC Radiated Emissions	FCC 15.109 (a) Class "A"

Reliability

Parameter	Specification
MTBF	IDU: > 18 years calculated ODU: > 50 years demonstrated

Electromagnetic Compliance

Parameter	Specification
EMC test methods	EN 301 489-1 V1.8 (2008-04) EN 301 489-4 V1.4.1 (2009-02)
Power Line Harmonics	EN 61000-3-2:2006
Power Line Fluctuations/Flicker	EN 61000-3-3:2008
Electrostatic Discharge (ESD)	EN 61000-4-2:2009
Radiated RF immunity	EN 61000 -4-3:2004, Radiated at 3 V/m
Electrical Fast transients	EN 61000-4-4:2004
Power Line Surge Immunity	EN 61000-4-5:2006
Powerline RF conducted immunity	EN 61000-4-6:2005
Voltage Dips and Short Interruptions	EN 61000-1-4-11:2004

Wireless Compliance

Parameter	Specification
FCC	CFR47 Part 101 CFR47 Part 15 Class A unintentional radiator
Canada	SRSP-xx
Europe (Harmonized)	EN 302 217-2-1 EN 302 217-2-2
Australia	RALI FX5
New Zealand	PIB22

Wireless Parameters

Parameter	Specification
Frequency Range	6-40 GHz
Channel Sizes Supported	3.5,5, 7,8.33, 10 , 12.5,13.75, 14, 20, 25, 27.5, 28, 30, 40, 50, 55, 56, 80 MHz
Fixed Modulation Set Levels	QAM256, QAM128, QAM64, QAM32, QAM16, QPSK
Transmitter Power Accuracy	+/- 2 dB
Transmitter Frequency Accuracy	+/- 7 ppm
Transmitter Center Frequency Synthesizer step size	250 kHz
Transmitter Output Power (Muted)	< -50 dBm
Transmitter Output Return Loss	> 10 dB
Adaptive Modulation Set Levels	QAM256, QAM128, QAM64, QAM32, QAM16
Adaptive Modulation Type	Error Free, Hitless through each transition
Adaptive Modulation Transitions Thresholds	User Settable MSE thresholds
Automatic Transmitter Power Control	> 15 dB range, user configurable step size and max power limit

Transmitter Power

Modulation	Maximum Transmit Power by Frequency (dBm)					
	6, 7, 8	10	11	13,15	18-26	28-40
QPSK	30	26.5	28	26	25	23
16QAM	28	22.5	26	23	22	21
32QAM	28	22.5	26	23	22	21
64QAM	25	20.5	22	21	20	17
128QAM	25	20.5	22	21	20	17
256QAM	24	18.5	21	20	19	16

Radio Sensitivity

Channel Width (MHz)	Symbol Rate (Msps)	Receive Sensitivity (dBm) 6-26 GHz					
		QPSK	QAM 16	QAM 32	QAM 64	QAM 128	QAM 256
3.5	3	-96.6	-90.4	-86.4	-84	-80.9	-77.9
5	4.3	-94.4	-88.8	-84.8	-82.1	-79.0	-76.0
7	5.6	-93.3	-87.7	-83.7	-81.3	-78.2	-75.2
8.33	7.2	-92.7	-86.5	-82.5	-80.3	-77.5	-74.4
10	8.32	-92.2	-86.0	-82.0	-79.6	-76.5	-73.5
12.5	10.8	-91.3	-85.4	-81.1	-78.7	-75.4	-72.4
14	12.2	-90.5	-84.3	-80.3	-77.9	-74.8	-71.8
20	17.42	-89.0	-82.8	-78.8	-76.4	-73.3	-70.3
25	21.8	-88.1	-82.0	-78	-75.4	-72.3	-69.3
28/30	26	-87.3	-81.1	-77.1	-74.7	-71.6	-68.6
40	34.83	-86.0	-79.8	-75.8	-73.4	-70.3	-67.3
50	43	-85.1	-78.9	-74.9	-72.5	-69.4	-66.4
55/56/80	50	-84.5	-78.3	-74.3	-71.9	-68.8	-65.8*

*-63.8 dBm when set to speed 80 qam256

Channel Width (MHz)	Symbol Rate (Msps)	Receive Sensitivity (dBm) 28-40 GHz					
		QPSK	QAM 16	QAM 32	QAM 64	QAM 128	QAM 256
3.5	3	-93.6	-87.4	-83.4	-81.0	-77.9	-74.9
5	4.3	-91.4	-85.8	-81.8	-79.1	-76.0	-73.0
7	5.6	-90.9	-84.7	-80.7	-78.3	-75.2	-72.2
8.33	7.2	-89.7	-83.5	-79.5	-77.3	-74.5	-71.4
10	8.32	-89.2	-83.0	-79.0	-76.6	-73.5	-70.5
12.5	10.8	-88.3	-82.4	-78.1	-75.7	-72.4	-69.4
14	12.2	-87.5	-81.3	-77.3	-74.9	-71.8	-68.8
20	17.42	-86.0	-79.8	-75.8	-73.4	-70.3	-67.3
25	21.8	-85.1	-79.0	-75	-72.4	-69.3	-66.3
28/30	26	-84.4	-78.1	-74.1	-71.7	-68.6	-65.6
40	34.83	-83.0	-76.8	-72.8	-70.4	-67.3	-64.3
50	43	-82.1	-75.9	-71.9	-69.5	-66.4	-63.4
55/56/80	50	-81.5	-75.3	-71.3	-68.9	-65.8	-62.8**

** -60.8 dBm when set to speed 80 qam256

1+1 Hot Standby Link Protection

Parameter	Specification
Failover Time	150 mSec typical
Guard Time	User configurable 10 to 60 seconds

Power

Parameter	Specification
Input Voltage Range	-40 to -72 VDC
Power Consumption	IDU: Max 35 Watts with all ports active ODU: Typical 25 Watts, max 50 Watts

User Interfaces

Description	Specification
Ethernet Traffic Ports and/or In Band Management (IBM)	ETH1 and ETH2: RJ45 Jack - 10/100/1000BaseT ETH3 and ETH4: SFP - 1000BaseT for SFP Module: SFP-GigE-C (1000BaseT) SFP-GigE-S (1000BaseLX Single Mode Fiber) SFP-GigE-M (1000BaseLX Multimode Fiber)
Out of Band Management (OBM)	RJ45 Jack- 10/100BaseT
T1/E1 Ports 1-8	RJ45 Jack
Alarm Inputs (2)	0-5 Volt high impedance CMOS level
Alarm Outputs (2)	DB9 Female, 50 Volt 1 Amp rated, Dry contact
PowerInput	3 Position latching screw terminal Block with locking screws
Console/Craft Port	DB9 Male(requires Serial Cable)
1+1 Redundancy Port	RJ45 Jack (requires CBLDAT-RIU3)
RSSI Alignment	BNC-Female (CBLDAT-RSSI recommended)
Reset IP/Config	Momentary Push Button on IDU front panel
Reboot System	Momentary Push Button on IDU front panel
Antenna	Slip-Fit Circular Waveguide for 7-40 GHz Slip-Fit Rectangular Waveguide for 6 GHz

Ethernet Parameters

Parameter	Specification
Packet Size	64-9600 Bytes , IPV4, IPV6
Max Capacity	L1: 414 Mbps L2: 375 Mbps
Data Latency	< 100 uS for 64 byte packets, Max capacity (per RFC2544 store and forward)
QoS	802.1p VLAN Priority for tagged packets: Diffserv Layer 3 Traffic prioritization using DSCP 802.1p Port Prioritization for untagged traffic Port mapping to isolate traffic between ports 8 Classes of Service mapped to 8 Queues Bandwidth Shaping per port (Ingress Rate limiting)
RSTP	Rapid Port Shutdown both ends of link within 50 mSec of link drop

T1/E1 Parameters

Parameter	Specification
Clock Source	External
T1 Compliance	T/O 1002-1993 ITU-T.G824 GR-499-CORE
T1 Bit Rate	1544+/- 10 ppm
T1 Impedance	100 Ohm Balanced
T1 Line Code	AMI or B8ZS
E1 Compliance	ITU-T G.703 ITU-T G.823
E1 Bit Rate	2048 Kbps +/- 50 ppm
E1 Impedance	120 Ohm Balanced
E1 Line Code	HDB3

Appendix C – Cable Wiring

This appendix shows the wiring of the various interfaces on the GigaPlus unit.

Ethernet Cabling

The Figures below show the cable pin-outs for straight-through and cross-over Ethernet cables. The images below conform to EIA/TIA industry standard for 568 A and B.

If the first and second pins are orange, the cable is 568B. If the first and second pins are green, the cable is 568A (Figure 46).

If one end of the cable is A and the other end is B it is a cross-over cable.

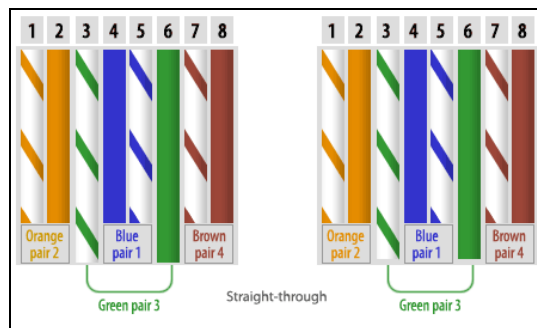

Figure 59 EIA/TIA 568A Straight through

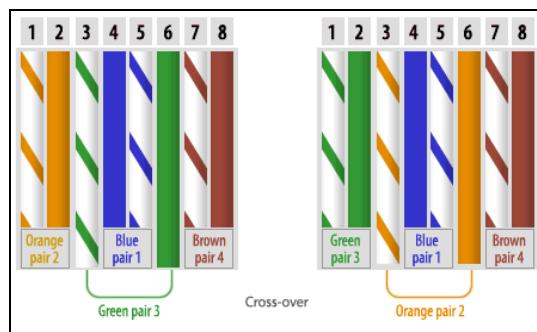

Figure 60 EIA/TIA 568B Cross-Over

T1/E1 Cabling

The Figure below show the cable pin-outs for T1/E1 cabling to interface to the RJ45 Jacks on the front panel.

RJ45 Pin	Signal	Notes
1	RX1 (Ring - negative)	
2	RX2 (TIP - positive)	
3	FGND (RX GND)	Ground/Shield
4	TX1 (Ring - negative)	
5	TX2 (TIP - positive)	
6	FGND (TX GND)	Ground/Shield
7	NC	Unused
8	NC	Unused

Table 14 T1/E1 Cable Wiring

DB9 Port Interfaces

DB9 Console cable Pin-outs

The console cable is a null modem cable with female DB9 connectors (Figure 48) on both sides. The pin outs for creating a console cable are listed in Table 13.

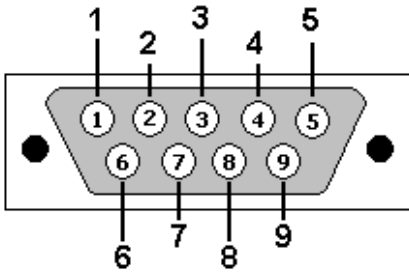

Figure 61 Console Cable Connector

Console Cable Pin outs			
IDU	Signal	Direction	PC
1,6	CD	IN	4
2	RxD	IN	3
3	TxD	OUT	2
4	DTR	OUT	1,6
5	GND		5
7	RTS	OUT	8
	CTS	IN	7

Table 15 Console Cable Pin-outs

DB9 Alarm Port Pin-outs

The alarm port on the IDU is a DB9 female connector (Figure 49). The pin outs of the alarm port are listed in Table 14

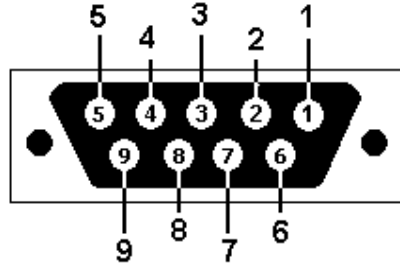

Figure 62 Alarm Port Pin Identification

Pins	Function
1	Relay 1 Com
2	Relay 1 NC
3	Relay 1 NO
4	Input 1, 0-5V input
5	Ground
6	Relay 2 Com
7	Relay 2 NC
8	Relay 2 NO
9	Input 1, 0-5V input

Table 16 Alarm Port Pin Functions

Appendix D – MIB OID Listing

MIB-II System

Object ID	Name	Type	Access	Range Limit	Default Value
.1.3.6.1.2.1.1.1.0	sysDescr	DisplayString	RO	N/A	GigaPlus-1.0
.1.3.6.1.2.1.1.2.0	sysObjectID	OID	RO	N/A	.1.3.6.1.4.1.5454.1.80
.1.3.6.1.2.1.1.3.0	sysUpTime	TimeTicks	RO	N/A	N/A
.1.3.6.1.2.1.1.4.0	sysContact	DisplayString	RO	N/A	Tech Support
.1.3.6.1.2.1.1.5.0	sysName	DisplayString	RO	N/A	Administrator
.1.3.6.1.2.1.1.6.0	sysLocation	DisplayString	RO	N/A	USA

Trango

Object ID	Name	Type	Access	Range Limit	Default Value
.1.3.6.1.4.1.5454.1.80.1.1.1.0	sysFPGAVer	DisplayString	RO	N/A	N/A
.1.3.6.1.4.1.5454.1.80.1.1.2.0	sysOSVer	DisplayString	RO	N/A	N/A
.1.3.6.1.4.1.5454.1.80.1.1.3.0	sysFWVer	DisplayString	RO	N/A	N/A
.1.3.6.1.4.1.5454.1.80.1.1.4.0	sysPICVer	DisplayString	RO	N/A	N/A
.1.3.6.1.4.1.5454.1.80.1.1.5.0	sysModemVer	DisplayString	RO	N/A	N/A
.1.3.6.1.4.1.5454.1.80.1.1.6.0	sysODUFWVer	DisplayString	RO	N/A	N/A
.1.3.6.1.4.1.5454.1.80.1.2.1.0	sysFPGAPreVer	DisplayString	RO	N/A	N/A
.1.3.6.1.4.1.5454.1.80.1.2.2.0	sysOSPreVer	DisplayString	RO	N/A	N/A
.1.3.6.1.4.1.5454.1.80.1.2.3.0	sysFWPreVer	DisplayString	RO	N/A	N/A
.1.3.6.1.4.1.5454.1.80.1.2.4.0	sysPICPreVer	DisplayString	RO	N/A	N/A
.1.3.6.1.4.1.5454.1.80.1.2.5.0	sysModemPreVer	DisplayString	RO	N/A	N/A
.1.3.6.1.4.1.5454.1.80.1.2.6.0	sysODUFWPreVer	DisplayString	RO	N/A	N/A
.1.3.6.1.4.1.5454.1.80.1.3.1.0	sysIDUModel	DisplayString	RO	N/A	N/A
.1.3.6.1.4.1.5454.1.80.1.3.2.0	sysODUModel	DisplayString	RO	N/A	N/A
.1.3.6.1.4.1.5454.1.80.1.3.3.0	sysIDUSerialID	DisplayString	RO	N/A	N/A
.1.3.6.1.4.1.5454.1.80.1.3.4.0	sysODUSerialID	DisplayString	RO	N/A	N/A
.1.3.6.1.4.1.5454.1.80.1.4.1.0	sysMACeth1	DisplayString	RO	N/A	N/A
.1.3.6.1.4.1.5454.1.80.1.4.2.0	sysMACeth2	DisplayString	RO	N/A	N/A
.1.3.6.1.4.1.5454.1.80.1.5.1.0	sysIpAddress	IpAddr	RW	string size 16 (A.B.C.D)	192.168.100.100
.1.3.6.1.4.1.5454.1.80.1.5.2.0	sysSubnetMask	IpAddr	RW	string size 16 (A.B.C.D)	255.255.255.0
.1.3.6.1.4.1.5454.1.80.1.5.3.0	sysDefaultGateway	IpAddr	RW	string size 16 (A.B.C.D)	192.168.100.100
.1.3.6.1.4.1.5454.1.80.1.6.1	sysRemarkSystem	DisplayString	RW	string size 1..100	TrangoLink GigaPlus
.1.3.6.1.4.1.5454.1.80.1.7.1	sysIBMEnable	Integer	RW	0(Off), 1(On)	0(Off)
.1.3.6.1.4.1.5454.1.80.1.7.2	sysIBMIp	IpAddr	RW	string size 16 (A.B.C.D)	172.168.1.1
.1.3.6.1.4.1.5454.1.80.1.7.3	sysIBMNetmask	IpAddr	RW	string size 16 (A.B.C.D)	255.255.0.0
.1.3.6.1.4.1.5454.1.80.1.7.4	sysIBMVlanID	Integer	RW	0-4090	1
.1.3.6.1.4.1.5454.1.80.1.7.5	sysIBMVlanPort	Integer	RW	1 to 4	ge1
.1.3.6.1.4.1.5454.1.80.1.8.1	sysSNMPReadCommStr	DisplayString	RW	string size 1-32	public
.1.3.6.1.4.1.5454.1.80.1.8.2	sysSNMPWriteCommStr	DisplayString	RW	string size 1-32	private
.1.3.6.1.4.1.5454.1.80.1.8.3	sysSNMPTrapCommStr	DisplayString	RW	string size 1-32	trapstr
.1.3.6.1.4.1.5454.1.80.1.9.1.1	sysSNMPTrap1Enable	Integer	RW	0(Off), 1(On)	0(OFF)
.1.3.6.1.4.1.5454.1.80.1.9.1.2	sysSNMPTrap1Ip	IpAddr	RW	string size 16 (A.B.C.D)	0.0.0.0
.1.3.6.1.4.1.5454.1.80.1.9.2.1	sysSNMPTrap2Enable	Integer	RW	0(Off), 1(On)	0(OFF)
.1.3.6.1.4.1.5454.1.80.1.9.2.2	sysSNMPTrap2Ip	IpAddr	RW	string size 16 (A.B.C.D)	0.0.0.0
.1.3.6.1.4.1.5454.1.80.1.9.3.1	sysSNMPTrap3Enable	Integer	RW	0(Off), 1(On)	0(OFF)
.1.3.6.1.4.1.5454.1.80.1.9.3.2	sysSNMPTrap3Ip	IpAddr	RW	string size 16 (A.B.C.D)	0.0.0.0
.1.3.6.1.4.1.5454.1.80.1.9.4.1	sysSNMPTrap4Enable	Integer	RW	0(Off), 1(On)	0(OFF)
.1.3.6.1.4.1.5454.1.80.1.9.4.2	sysSNMPTrap4Ip	IpAddr	RW	string size 16 (A.B.C.D)	0.0.0.0
.1.3.6.1.4.1.5454.1.80.1.9.5.1	sysSNMPTrap5Enable	Integer	RW	0(Off), 1(On)	0(OFF)
.1.3.6.1.4.1.5454.1.80.1.9.5.2	sysSNMPTrap5Ip	IpAddr	RW	string size 16 (A.B.C.D)	0.0.0.0
.1.3.6.1.4.1.5454.1.80.1.10.1	sysImageUpgrade	Integer	RW	1(IDU), 2(ODU)	0 (NA)
.1.3.6.1.4.1.5454.1.80.1.10.2	sysImageUpgradeStatus	Integer	RO	0(NA), 1(Failed)	0(NA)
.1.3.6.1.4.1.5454.1.80.1.10.3	sysImageToggle	Integer	RW	1(Toggle)	0(NA)
.1.3.6.1.4.1.5454.1.80.1.11.0	sysConfigOption	Integer	RW	1(Export), 2(Import), 3(Remove), 4(Save)	0(NA)
.1.3.6.1.4.1.5454.1.80.1.12.1.0	sysDiagnostic	Integer	RW	1(Export)	0(NA)
.1.3.6.1.4.1.5454.1.80.1.12.2.0	sysDiagnosticStatus	Integer	RO	0(NA), 1(Failed)	0(NA)
.1.3.6.1.4.1.5454.1.80.1.13.1.0	sysSyslogExport	Integer	RW	1(Export), 2(Clear)	0(NA)
.1.3.6.1.4.1.5454.1.80.1.13.2.0	sysSyslogLevel	Integer	RW		3
.1.3.6.1.4.1.5454.1.80.1.14.0	sysReboot	Integer	RW	1(REBOOT)	0 (NA)
.1.3.6.1.4.1.5454.1.80.1.15.0	sysResetOption	Integer	RW	0(Factory Default), 1(IP), 2(License)	0 (NA)
.1.3.6.1.4.1.5454.1.80.1.16.0	sysDatapath	Integer	RW	0(ETH only), 1(ETH+T1), 2(ETH+E1)	0(ETH only)
.1.3.6.1.4.1.5454.1.80.1.17.1.0	sysAlarm1	Integer	RW	0(Off), 1(On)	0(Off)
.1.3.6.1.4.1.5454.1.80.1.17.2.0	sysAlarm2	Integer	RW	0(Off), 1(On)	0(Off)
.1.3.6.1.4.1.5454.1.80.1.18.0	sysFanCtrl	Integer	RW	0(FanOff), 1(Fan1On), 2 (Fan2On)	1(Fan1On)
.1.3.6.1.4.1.5454.1.80.1.19.0	sysIDUTemp	Integer	RO	N/A	N/A
.1.3.6.1.4.1.5454.1.80.1.20.1.0	sysHTTPD	Integer	RW	0(Off), 1(On)	0(Off)
.1.3.6.1.4.1.5454.1.80.1.20.2.0	sysSNMPD	Integer	RW	0(Off), 1(On)	1(On)
.1.3.6.1.4.1.5454.1.80.1.20.3.0	sysTFTPd	Integer	RO	0(Off), 1(On)	1(On)
.1.3.6.1.4.1.5454.1.80.1.20.4.0	sysTelnetD	Integer	RW	0(Off), 1(On)	0(Off)
.1.3.6.1.4.1.5454.1.80.1.21.0	sysRPSEnable	Integer	RW	0(Off), 1(On)	0(Off)
.1.3.6.1.4.1.5454.1.80.1.22.0	sysClearCounter	Integer	RW	1(Clear)	0(NA)
.1.3.6.1.4.1.5454.1.80.1.23.1.0	sysTdmMode	Integer	RO	0(T1), 1(E1)	0(T1)
.1.3.6.1.4.1.5454.1.80.1.23.2.0	sysTdmCoding	Integer	RO	0(AMI), 1(B8ZS), 2(HDB3)	0(AMI)
.1.3.6.1.4.1.5454.1.80.1.24.1.1.0	sysSpeedLicenseEnable	Integer	RO	0(Disable), 1(Enable)	0(Disable)

Trango, cont'd

.1.3.6.1.4.1.5454.1.80.1.24.1.2.0	sysSpeedLicenseKey1	String	RW	N/A	N/A
.1.3.6.1.4.1.5454.1.80.1.24.1.3.0	sysSpeedLicenseKey2	String	RW	N/A	N/A
.1.3.6.1.4.1.5454.1.80.1.24.2.1.0	sysTDMLicenseEnable	Integer	RO	0(Disable), 1(Enable)	0(Disable)
.1.3.6.1.4.1.5454.1.80.1.24.2.2.0	sysTDMLicenseKey	String	RW	N/A	N/A
.1.3.6.1.4.1.5454.1.80.1.25.0	sysIDULED	Integer	RW	0(RSSI), 1 (TDM)	0(RSSI)
.1.3.6.1.4.1.5454.1.80.1.26.0	sysFailoverMode	Integer	RW	0(Off), 1(On with port OFF), 2(ON with port ON)	0
.1.3.6.1.4.1.5454.1.80.1.27.0	sysUtype	Integer	RO	0(NO Utype), 1 (Active), 2(Standby)	1(Active)
.1.3.6.1.4.1.5454.1.80.1.28.0	sysSync	Integer	RW	1(sync)	N/A
.1.3.6.1.4.1.5454.1.80.1.29.1.0	sysStandbyLinkStatus	Integer	RO	0(No Lock), 1(Lock)	N/A
.1.3.6.1.4.1.5454.1.80.1.29.2.0	sysStandbyODUStatus	Integer	RO	0(No Lock), 1(Lock)	N/A
.1.3.6.1.4.1.5454.1.80.1.29.3.0	sysStandbyRSSI	Integer	RO	N/A	N/A
.1.3.6.1.4.1.5454.1.80.1.29.4.0	sysStandbyMSE	Integer	RO	N/A	N/A
.1.3.6.1.4.1.5454.1.80.1.30.0	sysGuardTime	Integer	RW	10-60 seconds	15 second
.1.3.6.1.4.1.5454.1.80.1.31.1.0	sysReloadIn	Integer	RW	1-240 minutes	10 minutes
.1.3.6.1.4.1.5454.1.80.1.31.2.0	sysReloadCancel	Integer	RW	1(Cancel)	N/A
.1.3.6.1.4.1.5454.1.80.1.31.3.0	sysReloadRemain	Integer	RW	0	N/A
.1.3.6.1.4.1.5454.1.80.1.32.1.0	sysStatusSave	Integer	RW	1(Save)	N/A
.1.3.6.1.4.1.5454.1.80.1.32.2.0	sysStatusCompare	Integer	RW	1(Compare)	N/A
.1.3.6.1.4.1.5454.1.80.1.33.1.0	sysRemoteLinkStatus	Integer	RO	0(No Lock), 1(Lock)	N/A
.1.3.6.1.4.1.5454.1.80.1.33.2.0	sysRemoteODUStatus	Integer	RO	0(No Lock), 1(Lock)	N/A
.1.3.6.1.4.1.5454.1.80.1.33.3.0	sysRemoteRSSI	Integer	RO	N/A	N/A
.1.3.6.1.4.1.5454.1.80.1.33.4.0	sysRemoteMSE	Integer	RO	N/A	N/A
.1.3.6.1.4.1.5454.1.80.1.34.1.1.0	sysThresholdRSSIMin	Opaque(Float)	RW		-85
.1.3.6.1.4.1.5454.1.80.1.34.1.2.0	sysThresholdRSSIMax	Opaque(Float)	RW		-20
.1.3.6.1.4.1.5454.1.80.1.34.1.3.0	sysThresholdRSSIAction	Integer	RW	0(none), 1(alarm1), 2(alarm2), 3(trap),4(rps), 5(switchover)	0 (none)
.1.3.6.1.4.1.5454.1.80.1.34.2.1.0	sysThresholdMSEMin	Opaque(Float)	RW		-45
.1.3.6.1.4.1.5454.1.80.1.34.2.2.0	sysThresholdMSEMax	Opaque(Float)	RW		-15
.1.3.6.1.4.1.5454.1.80.1.34.2.3.0	sysThresholdMSEAction	Integer	RW	0(none), 1(alarm1), 2(alarm2), 3(trap),4(rps), 5(switchover)	0 (none)
.1.3.6.1.4.1.5454.1.80.1.34.3.1.0	sysThresholdBERMin	Opaque(Float)	RW		0
.1.3.6.1.4.1.5454.1.80.1.34.3.2.0	sysThresholdBERMax	Opaque(Float)	RW		1
.1.3.6.1.4.1.5454.1.80.1.34.3.3.0	sysThresholdBERAction	Integer	RW	0(none), 1(alarm1), 2(alarm2), 3(trap),4(rps), 5(switchover)	0 (none)
.1.3.6.1.4.1.5454.1.80.1.34.4.1.0	sysThresholdFERMin	Opaque(Float)	RW		0
.1.3.6.1.4.1.5454.1.80.1.34.4.2.0	sysThresholdFERMax	Opaque(Float)	RW		1
.1.3.6.1.4.1.5454.1.80.1.34.4.3.0	sysThresholdFERAction	Integer	RW	0(none), 1(alarm1), 2(alarm2), 3(trap),4(rps), 5(switchover)	0 (none)
.1.3.6.1.4.1.5454.1.80.1.34.5.1.0	sysThresholdIDUTempMin	Opaque(Float)	RW		-10
.1.3.6.1.4.1.5454.1.80.1.34.5.2.0	sysThresholdIDUTempMax	Opaque(Float)	RW		55
.1.3.6.1.4.1.5454.1.80.1.34.5.3.0	sysThresholdIDUTempAction	Integer	RW	0(none), 1(alarm1), 2(alarm2), 3(trap),4(rps), 5(switchover)	0 (none)
.1.3.6.1.4.1.5454.1.80.1.34.6.1.0	sysThresholdODUTempMin	Opaque(Float)	RW		-40
.1.3.6.1.4.1.5454.1.80.1.34.6.2.0	sysThresholdODUTempMax	Opaque(Float)	RW		58
.1.3.6.1.4.1.5454.1.80.1.34.6.3.0	sysThresholdODUTempAction	Integer	RW	0(none), 1(alarm1), 2(alarm2), 3(trap),4(rps), 5(switchover)	0 (none)
.1.3.6.1.4.1.5454.1.80.1.34.7.1.0	sysThresholdInPortUtilMin	Opaque(Float)	RW		0
.1.3.6.1.4.1.5454.1.80.1.34.7.2.0	sysThresholdInPortUtilMax	Opaque(Float)	RW		100
.1.3.6.1.4.1.5454.1.80.1.34.7.3.0	sysThresholdInPortUtilAction	Integer	RW	0(none), 1(alarm1), 2(alarm2), 3(trap),4(rps), 5(switchover)	0 (none)
.1.3.6.1.4.1.5454.1.80.1.34.8.1.0	sysThresholdOutPortUtilMin	Opaque(Float)	RW		0
.1.3.6.1.4.1.5454.1.80.1.34.8.2.0	sysThresholdOutPortUtilMax	Opaque(Float)	RW		100
.1.3.6.1.4.1.5454.1.80.1.34.8.3.0	sysThresholdOutPortUtilAction	Integer	RW	0(none), 1(alarm1), 2(alarm2), 3(trap),4(rps), 5(switchover)	0 (none)
.1.3.6.1.4.1.5454.1.80.1.34.9.1.0	sysThresholdLinkDownAction	Integer	RW	0(none), 1(alarm1), 2(alarm2), 3(trap),4(rps), 5(switchover)	0 (none)
.1.3.6.1.4.1.5454.1.80.1.35.0	sysEgressMargin	Integer	RW	-90 to 90 %	0%
.1.3.6.1.4.1.5454.1.80.1.36.0	sysQOSMode	Integer	RW	0(strict), 1(DSCP)	0(strict)
.1.3.6.1.4.1.5454.1.80.1.37.0	sysWebRefreshRate	Integer	RW	0-300	5 seconds
.1.3.6.1.4.1.5454.1.80.1.38.0	sysSmartMode	Integer	RW	0(Off), 1(On)	1(On)

Modem Section

Object ID	Name		Access	Range Limit	Default Value
.1.3.6.1.4.1.5454.1.80.2.1.0	modemLoopbackMode	Integer	RW	0(Off), 1(Digital), 2(IF), 3(Rf_gen), 4(Rf_refl)	0(Off)
.1.3.6.1.4.1.5454.1.80.2.2.0	modemDataPattern	Integer	RW	0(FPGA), 1(Modem)	0(FPGA)
.1.3.6.1.4.1.5454.1.80.2.3.1.0	modemACMEnable	Integer	RW	0(Off), 1(On)	0(Off)
.1.3.6.1.4.1.5454.1.80.2.3.2.1.0	modemACMProfileQPSKEnable	Integer	RO	0(Off), 1(On)	1(On)
.1.3.6.1.4.1.5454.1.80.2.3.2.2.0	modemACMProfile16QEnable	Integer	RO	0(Off), 1(On)	1(On)
.1.3.6.1.4.1.5454.1.80.2.3.2.3.0	modemACMProfile32QEnable	Integer	RO	0(Off), 1(On)	1(On)
.1.3.6.1.4.1.5454.1.80.2.3.2.4.0	modemACMProfile64QEnable	Integer	RO	0(Off), 1(On)	1(On)
.1.3.6.1.4.1.5454.1.80.2.3.2.5.0	modemACMProfile128QEnable	Integer	RO	0(Off), 1(On)	1(On)
.1.3.6.1.4.1.5454.1.80.2.3.2.6.0	modemACMProfile256QEnable	Integer	RO	0(Off), 1(On)	1(On)
.1.3.6.1.4.1.5454.1.80.2.3.3.1.1.0	modemACMQPSKMSEImprove	Opaque(Float)	RW	(-45) – 0	-20.3
.1.3.6.1.4.1.5454.1.80.2.3.3.1.2.0	modemACMQPSKMSEImproveInt	Integer	RW		
.1.3.6.1.4.1.5454.1.80.2.3.3.2.1.0	modemACM16QMSEImprove	Opaque(Float)	RW	(-45) – 0	-25.3
.1.3.6.1.4.1.5454.1.80.2.3.3.2.2.0	modemACM16QMSEImproveInt	Integer	RW		
.1.3.6.1.4.1.5454.1.80.2.3.3.3.1.0	modemACM32QMSEImprove	Opaque(Float)	RW	(-45) – 0	-26.3
.1.3.6.1.4.1.5454.1.80.2.3.3.3.2.0	modemACM32QMSEImproveInt	Integer	RW		
.1.3.6.1.4.1.5454.1.80.2.3.3.4.1.0	modemACM64QMSEImprove	Opaque(Float)	RW	(-45) – 0	-29.2
.1.3.6.1.4.1.5454.1.80.2.3.3.4.2.0	modemACM64QMSEImproveInt	Integer	RW		
.1.3.6.1.4.1.5454.1.80.2.3.3.5.1.0	modemACM128QMSEImprove	Opaque(Float)	RW	(-45) – 0	-32.1
.1.3.6.1.4.1.5454.1.80.2.3.3.5.2.0	modemACM128QMSEImproveInt	Integer	RW		
.1.3.6.1.4.1.5454.1.80.2.3.3.6.1.0	modemACM256QMSEImprove	Opaque(Float)	RW	(-45) – 0	-32.1
.1.3.6.1.4.1.5454.1.80.2.3.3.6.2.0	modemACM256QMSEImproveInt	Integer	RW		
.1.3.6.1.4.1.5454.1.80.2.3.4.1.1.0	modemACMQPSKMSEDegrade	Opaque(Float)	RW	(-45) – 0	-17.1
.1.3.6.1.4.1.5454.1.80.2.3.4.1.2.0	modemACMQPSKMSEDegradeInt	Integer	RW		
.1.3.6.1.4.1.5454.1.80.2.3.4.2.1.0	modemACM16QMSEDegrade	Opaque(Float)	RW	(-45) – 0	-18.5
.1.3.6.1.4.1.5454.1.80.2.3.4.2.2.0	modemACM16QMSEDegradeInt	Integer	RW		
.1.3.6.1.4.1.5454.1.80.2.3.4.3.1.0	modemACM32QMSEDegrade	Opaque(Float)	RW	(-45) – 0	-21.3
.1.3.6.1.4.1.5454.1.80.2.3.4.3.2.0	modemACM32QMSEDegradeInt	Integer	RW		
.1.3.6.1.4.1.5454.1.80.2.3.4.4.1.0	modemACM64QMSEDegrade	Opaque(Float)	RW	(-45) – 0	-24.3
.1.3.6.1.4.1.5454.1.80.2.3.4.4.2.0	modemACM64QMSEDegradeInt	Integer	RW		
.1.3.6.1.4.1.5454.1.80.2.3.4.5.1.0	modemACM128QMSEDegrade	Opaque(Float)	RW	(-45) – 0	-27.2
.1.3.6.1.4.1.5454.1.80.2.3.4.5.2.0	modemACM128QMSEDegradeInt	Integer	RW		
.1.3.6.1.4.1.5454.1.80.2.3.4.6.1.0	modemACM256QMSEDegrade	Opaque(Float)	RW	(-45) – 0	-27.2
.1.3.6.1.4.1.5454.1.80.2.3.4.6.2.0	modemACM256QMSEDegradeInt	Integer	RW		
.1.3.6.1.4.1.5454.1.80.2.3.5.1.0	modemACMTxProfile	Integer	RO	0(QPSK), 1(16Q),2(32Q),3(64Q),4(128Q), 5(256Q) for non-256Q, 0(QPSK), 1(16Q),2(64Q), 3(256Q) for 256Q	N/A
.1.3.6.1.4.1.5454.1.80.2.3.5.2.0	modemACMRxProfile	Integer	RO	0(QPSK), 1(16Q),2(32Q),3(64Q),4(128Q), 5(256Q) for non-256Q, 0(QPSK), 1(16Q),2(64Q), 3(256Q) for 256Q	N/A
.1.3.6.1.4.1.5454.1.80.2.4.1.0	modemBER	Integer	RO	N/A	N/A
.1.3.6.1.4.1.5454.1.80.2.4.2.1.0	modemMSE	Integer	RO	N/A	N/A
.1.3.6.1.4.1.5454.1.80.2.4.2.2.0	modemMSEInt	Integer	RO	N/A	N/A
.1.3.6.1.4.1.5454.1.80.2.4.2.3.0	modemMSEInst	Integer	RO	N/A	N/A
.1.3.6.1.4.1.5454.1.80.2.4.3.0	modemFER	Integer	RO	N/A	N/A
.1.3.6.1.4.1.5454.1.80.2.5.1.0	modemLockStatus	Integer	RO	0(No Lock), 1(Lock)	N/A
.1.3.6.1.4.1.5454.1.80.2.5.2.0	modemTimingLock	Integer	RO	0(No Lock), 1(Lock)	N/A
.1.3.6.1.4.1.5454.1.80.2.5.3.0	modemPreambleLock	Integer	RO	0(No Lock), 1(Lock)	N/A
.1.3.6.1.4.1.5454.1.80.2.5.4.0	modemLDPCLock	Integer	RO	0(No Lock), 1(Lock)	N/A
.1.3.6.1.4.1.5454.1.80.2.6.1.0	modemLDPCStressDecoder	Integer	RO		
.1.3.6.1.4.1.5454.1.80.2.6.2.0	modemIDURSSI	Integer	RO		
.1.3.6.1.4.1.5454.1.80.2.6.3.0	modemRadioMSE	Integer	RO		
.1.3.6.1.4.1.5454.1.80.2.6.4.0	modemUncorrectedBlocks	Integer	RO		
.1.3.6.1.4.1.5454.1.80.2.7.1.0	modemCustomProfileAddRemove	Integer	RO		
.1.3.6.1.4.1.5454.1.80.2.7.2.0	modemCustomProfileInUse	Integer	RO		

RF Section

Object ID	Name	Access	Range Limit	Default Value
.1.3.6.1.4.1.5454.1.80.3.1.1.1.0	rfTxFrequency	Opaque(Float) RW	ODU model dependant [In MHz]	0
.1.3.6.1.4.1.5454.1.80.3.1.1.1.0	rfTxFrequencyInt	Integer RW	ODU model dependant [in KHz]	0
.1.3.6.1.4.1.5454.1.80.3.1.2.1.0	rfRxFrequency	Opaque(Float) RO	ODU model dependant [In MHz]	0
.1.3.6.1.4.1.5454.1.80.3.1.2.1.0	rfRxFrequencyInt	Integer RO	ODU model dependant [in KHz]	0
.1.3.6.1.4.1.5454.1.80.3.1.3.1.0	rfFreqDuplex	Opaque(Float) RW	ODU model dependant [In MHz]	0
.1.3.6.1.4.1.5454.1.80.3.1.3.1.0	rfFreqDuplexInt	Integer RW	ODU model dependant [in KHz]	0
.1.3.6.1.4.1.5454.1.80.3.1.4.1.0	rfFreqMax	Opaque(Float) RW	ODU model dependant [In MHz]	0
.1.3.6.1.4.1.5454.1.80.3.1.4.1.0	rfFreqMaxInt	Integer RW	ODU model dependant [in KHz]	0
.1.3.6.1.4.1.5454.1.80.3.1.5.1.0	rfFreqMin	Opaque(Float) RW	ODU model dependant [In MHz]	0
.1.3.6.1.4.1.5454.1.80.3.1.5.1.0	rfFreqMinInt	Integer RW	ODU model dependant [in KHz]	0
.1.3.6.1.4.1.5454.1.80.3.2.0	rfDefaultOpmode	Integer RW	0(Off), 1(On)	0(Off)
.1.3.6.1.4.1.5454.1.80.3.3.0	rfOpmode	Integer RW	0(Off), 1(On)	0(Off)
.1.3.6.1.4.1.5454.1.80.3.4.1.0	rfPower	Opaque(Float) RW	0-30	10
.1.3.6.1.4.1.5454.1.80.3.4.2.0	rfPowerInt	Integer RW	0-300	100
.1.3.6.1.4.1.5454.1.80.3.5.1.1.0	rfCableloss140	Opaque(Float) RW	0-20 [dB]	0
.1.3.6.1.4.1.5454.1.80.3.5.1.2.0	rfCableloss140Int	Integer RW	0-2000 [In 100ths of dB]	0
.1.3.6.1.4.1.5454.1.80.3.5.2.1.0	rfCableloss350	Opaque(Float) RW	0-30 [dB]	0
.1.3.6.1.4.1.5454.1.80.3.5.2.2.0	rfCableloss350Int	Integer RW	0-3000 [100ths of dB]	0
.1.3.6.1.4.1.5454.1.80.3.5.3.1.0	rfCableloss915	Opaque(Float) RW	0-50 [dB]	0
.1.3.6.1.4.1.5454.1.80.3.5.3.2.0	rfCableloss915Int	Integer RW	0-5000 [100ths of dB]	0
.1.3.6.1.4.1.5454.1.80.3.6.1.0	rfChannelsWidth	Integer RW	3-100	30
.1.3.6.1.4.1.5454.1.80.3.6.2.0	rfModulation	Integer RW	0(QPSK), 1(16Q), 2(32Q), 3(64Q), 4(128Q), 5(256Q)	QAM32
.1.3.6.1.4.1.5454.1.80.3.6.3.1.0	rfSymrate	Opaque(Float) RO	N/A	24.6
.1.3.6.1.4.1.5454.1.80.3.6.3.2.0	rfSymrateInt	Integer RO		
.1.3.6.1.4.1.5454.1.80.3.6.4.1.0	rfSpeed	Opaque(Float) RO	N/A	118
.1.3.6.1.4.1.5454.1.80.3.6.4.2.0	rfSpeedInt	Integer RO		
.1.3.6.1.4.1.5454.1.80.3.7.1.0	rfATPCEnable	Integer RW	0(Off), 1(On)	0(Off)
.1.3.6.1.4.1.5454.1.80.3.7.2.0	rfATPCMaxPower	Integer RW	ODU model dependant	ODU model dependant
.1.3.6.1.4.1.5454.1.80.3.7.3.0	rfATPCStepSize	Integer RW	0-5	1
.1.3.6.1.4.1.5454.1.80.3.8.0	rfAlignmentMode	Integer RW	0(Off), 1(On)	0(Off)
.1.3.6.1.4.1.5454.1.80.3.9.1.0	rfTargetRSSI	Opaque(Float) RW	(-88) ~ (-25)	-40
.1.3.6.1.4.1.5454.1.80.3.9.2.0	rfTargetRSSIInt	Integer RW	(-880) ~ (-250) [10ths of dB]	-40
.1.3.6.1.4.1.5454.1.80.3.10.0	rfODULEDEnable	Integer RW	0(Off), 1(On)	1(On)
.1.3.6.1.4.1.5454.1.80.3.11.0	rfODUPowerEnable	Integer RW	0(Off), 1(On)	0(Off)
.1.3.6.1.4.1.5454.1.80.3.12.0	rfODURxAGCEnable	Integer RW	0(Off), 1(On)	0(Off)
.1.3.6.1.4.1.5454.1.80.3.13.0	rfODUTemp	Integer RO	N/A	N/A
.1.3.6.1.4.1.5454.1.80.3.14.1.0	rfRSSI	Opaque(Float) RO	N/A	N/A
.1.3.6.1.4.1.5454.1.80.3.14.2.0	rfRSSIInt	Integer RO	N/A	N/A
.1.3.6.1.4.1.5454.1.80.3.14.3.0	rfRSSIInst	Opaque(Float) RO	N/A	N/A
.1.3.6.1.4.1.5454.1.80.3.15.1.0	rfODURFpll	Integer RO	0(No Lock), 1(Lock)	N/A
.1.3.6.1.4.1.5454.1.80.3.15.2.0	rfODUIFpll	Integer RO	0(No Lock), 1(Lock)	N/A
.1.3.6.1.4.1.5454.1.80.3.15.3.0	rfODUTxpll	Integer RO	0(No Lock), 1(Lock)	N/A
.1.3.6.1.4.1.5454.1.80.3.15.4.0	rfODURxpll	Integer RO	0(No Lock), 1(Lock)	N/A
.1.3.6.1.4.1.5454.1.80.3.15.5.0	rfIDUTxpll	Integer RO	0(No Lock), 1(Lock)	N/A
.1.3.6.1.4.1.5454.1.80.3.16.1.0	rfInDataOctets	Counter32 RO	N/A	N/A
.1.3.6.1.4.1.5454.1.80.3.16.2.0	rfInDataPackets	Counter32 RO	N/A	N/A
.1.3.6.1.4.1.5454.1.80.3.16.3.0	rfInDropPackets	Counter32 RO	N/A	N/A
.1.3.6.1.4.1.5454.1.80.3.16.4.0	rfInPortRate	Counter32 RO	N/A	N/A
.1.3.6.1.4.1.5454.1.80.3.16.5.0	rfInPortUtil	Counter32 RO	N/A	N/A
.1.3.6.1.4.1.5454.1.80.3.17.1.0	rfOutDataOctets	Counter32 RO	N/A	N/A
.1.3.6.1.4.1.5454.1.80.3.17.2.0	rfOutDataPackets	Counter32 RO	N/A	N/A
.1.3.6.1.4.1.5454.1.80.3.17.3.0	rfOutPortRate	Counter32 RO	N/A	N/A
.1.3.6.1.4.1.5454.1.80.3.17.4.0	rfOutPortUtil	Counter32 RO	N/A	N/A

Ethernet Section

Object ID	Name	Access	Range Limit	Default Value	
1.3.6.1.4.1.5454.1.80.4.1.1.1.0	gigeEth1AutoNegotiate	Integer	RW	0(Off), 1(On)	1(On)
1.3.6.1.4.1.5454.1.80.4.1.1.2.0	gigeEth1Duplex	Integer	RW	0(Half), 1(Full)	1(Full)
1.3.6.1.4.1.5454.1.80.4.1.1.3.0	gigeEth1Enable	Integer	RW	0(Off), 1(On)	1(On)
1.3.6.1.4.1.5454.1.80.4.1.1.4.0	gigeEth1MaxRate	Integer	RW	0-1000	1000
1.3.6.1.4.1.5454.1.80.4.1.1.5.0	gigeEth1PauseFrame	Integer	RW	0(Off), 1(On)	0(Off)
1.3.6.1.4.1.5454.1.80.4.1.1.6.0	gigeEth1Priority	Integer	RW	0-7	0
1.3.6.1.4.1.5454.1.80.4.1.1.7.0	gigeEth1Speed	Integer	RW	0, 100, 1000	1000
1.3.6.1.4.1.5454.1.80.4.1.1.8.0	gigeEth1Status	Integer	RO	0(Off), 1(On)	N/A
1.3.6.1.4.1.5454.1.80.4.1.1.9.0	gigeEth1Loopback	Integer	RW	0(Off), 1(phy), 2(mac)	N/A
1.3.6.1.4.1.5454.1.80.4.1.2.1.0	gigeEth1InOctets	Counter32	RO	0-4294967296	
1.3.6.1.4.1.5454.1.80.4.1.2.2.0	gigeEth1InUcastPackets	Counter32	RO	0-4294967296	
1.3.6.1.4.1.5454.1.80.4.1.2.3.0	gigeEth1InNcastPackets	Counter32	RO	0-4294967296	
1.3.6.1.4.1.5454.1.80.4.1.2.4.0	gigeEth1InTotalPackets	Counter32	RO	0-4294967296	
1.3.6.1.4.1.5454.1.80.4.1.2.5.0	gigeEth1OutOctets	Counter32	RO	0-4294967296	
1.3.6.1.4.1.5454.1.80.4.1.2.6.0	gigeEth1OutUcastPackets	Counter32	RO	0-4294967296	
1.3.6.1.4.1.5454.1.80.4.1.2.7.0	gigeEth1OutNcastPackets	Counter32	RO	0-4294967296	
1.3.6.1.4.1.5454.1.80.4.1.2.8.0	gigeEth1OutTotalPackets	Counter32	RO	0-4294967296	
1.3.6.1.4.1.5454.1.80.4.1.2.9.0	gigeEth1CRCERrors	Counter32	RO	0-4294967296	
1.3.6.1.4.1.5454.1.80.4.1.2.10.0	gigeEth1CollisionErrors	Counter32	RO	0-4294967296	
1.3.6.1.4.1.5454.1.80.4.1.2.11.0	gigeEth1InPortRate	Integer	RO	0-400	
1.3.6.1.4.1.5454.1.80.4.1.2.12.0	gigeEth1InPortUtil	Integer	RO	0-100	
1.3.6.1.4.1.5454.1.80.4.1.2.13.0	gigeEth1OutPortRate	Integer	RO	0-400	
1.3.6.1.4.1.5454.1.80.4.1.2.14.0	gigeEth1OutPortUtil	Integer	RO	0-100	
1.3.6.1.4.1.5454.1.80.4.1.3.1.0	gigeEth1DSCPSource1	Integer	RW	0-63	0
1.3.6.1.4.1.5454.1.80.4.1.3.2.0	gigeEth1DSCPSource2	Integer	RW	0-63	0
1.3.6.1.4.1.5454.1.80.4.1.3.3.0	gigeEth1DSCPSource3	Integer	RW	0-63	0
1.3.6.1.4.1.5454.1.80.4.1.3.4.0	gigeEth1DSCPSource4	Integer	RW	0-63	0
1.3.6.1.4.1.5454.1.80.4.1.3.5.0	gigeEth1DSCPSource5	Integer	RW	0-63	0
1.3.6.1.4.1.5454.1.80.4.1.3.6.0	gigeEth1DSCPSource6	Integer	RW	0-63	0
1.3.6.1.4.1.5454.1.80.4.1.3.7.0	gigeEth1DSCPSource7	Integer	RW	0-63	0
1.3.6.1.4.1.5454.1.80.4.1.3.8.0	gigeEth1DSCPSource8	Integer	RW	0-63	0
1.3.6.1.4.1.5454.1.80.4.1.3.9.0	gigeEth1DSCPSource9	Integer	RW	0-63	0
1.3.6.1.4.1.5454.1.80.4.1.3.10.0	gigeEth1DSCPSource10	Integer	RW	0-63	0
1.3.6.1.4.1.5454.1.80.4.1.3.11.0	gigeEth1DSCPSource11	Integer	RW	0-63	0
1.3.6.1.4.1.5454.1.80.4.1.3.12.0	gigeEth1DSCPSource12	Integer	RW	0-63	0
1.3.6.1.4.1.5454.1.80.4.1.3.13.0	gigeEth1DSCPSource13	Integer	RW	0-63	0
1.3.6.1.4.1.5454.1.80.4.1.3.14.0	gigeEth1DSCPSource14	Integer	RW	0-63	0
1.3.6.1.4.1.5454.1.80.4.1.3.15.0	gigeEth1DSCPSource15	Integer	RW	0-63	0
1.3.6.1.4.1.5454.1.80.4.1.3.16.0	gigeEth1DSCPSource16	Integer	RW	0-63	0
1.3.6.1.4.1.5454.1.80.4.1.3.17.0	gigeEth1DSCPSource17	Integer	RW	0-63	0
1.3.6.1.4.1.5454.1.80.4.1.3.18.0	gigeEth1DSCPSource18	Integer	RW	0-63	0
1.3.6.1.4.1.5454.1.80.4.1.3.19.0	gigeEth1DSCPSource19	Integer	RW	0-63	0
1.3.6.1.4.1.5454.1.80.4.1.3.20.0	gigeEth1DSCPSource20	Integer	RW	0-63	0
1.3.6.1.4.1.5454.1.80.4.1.3.21.0	gigeEth1DSCPSource21	Integer	RW	0-63	0
1.3.6.1.4.1.5454.1.80.4.1.3.22.0	gigeEth1DSCPSource22	Integer	RW	0-63	0
1.3.6.1.4.1.5454.1.80.4.1.3.23.0	gigeEth1DSCPSource23	Integer	RW	0-63	0
1.3.6.1.4.1.5454.1.80.4.1.3.24.0	gigeEth1DSCPSource24	Integer	RW	0-63	0
1.3.6.1.4.1.5454.1.80.4.1.3.25.0	gigeEth1DSCPSource25	Integer	RW	0-63	0
1.3.6.1.4.1.5454.1.80.4.1.3.26.0	gigeEth1DSCPSource26	Integer	RW	0-63	0
1.3.6.1.4.1.5454.1.80.4.1.3.27.0	gigeEth1DSCPSource27	Integer	RW	0-63	0
1.3.6.1.4.1.5454.1.80.4.1.3.28.0	gigeEth1DSCPSource28	Integer	RW	0-63	0
1.3.6.1.4.1.5454.1.80.4.1.3.29.0	gigeEth1DSCPSource29	Integer	RW	0-63	0
1.3.6.1.4.1.5454.1.80.4.1.3.30.0	gigeEth1DSCPSource30	Integer	RW	0-63	0
1.3.6.1.4.1.5454.1.80.4.1.3.31.0	gigeEth1DSCPSource31	Integer	RW	0-63	0
1.3.6.1.4.1.5454.1.80.4.1.3.32.0	gigeEth1DSCPSource32	Integer	RW	0-63	0
1.3.6.1.4.1.5454.1.80.4.1.3.33.0	gigeEth1DSCPSource33	Integer	RW	0-63	0
1.3.6.1.4.1.5454.1.80.4.1.3.34.0	gigeEth1DSCPSource34	Integer	RW	0-63	0
1.3.6.1.4.1.5454.1.80.4.1.3.35.0	gigeEth1DSCPSource35	Integer	RW	0-63	0
1.3.6.1.4.1.5454.1.80.4.1.3.36.0	gigeEth1DSCPSource36	Integer	RW	0-63	0
1.3.6.1.4.1.5454.1.80.4.1.3.37.0	gigeEth1DSCPSource37	Integer	RW	0-63	0
1.3.6.1.4.1.5454.1.80.4.1.3.38.0	gigeEth1DSCPSource38	Integer	RW	0-63	0
1.3.6.1.4.1.5454.1.80.4.1.3.39.0	gigeEth1DSCPSource39	Integer	RW	0-63	0
1.3.6.1.4.1.5454.1.80.4.1.3.40.0	gigeEth1DSCPSource40	Integer	RW	0-63	0
1.3.6.1.4.1.5454.1.80.4.1.3.41.0	gigeEth1DSCPSource41	Integer	RW	0-63	0
1.3.6.1.4.1.5454.1.80.4.1.3.42.0	gigeEth1DSCPSource41	Integer	RW	0-63	0
1.3.6.1.4.1.5454.1.80.4.1.3.43.0	gigeEth1DSCPSource42	Integer	RW	0-63	0
1.3.6.1.4.1.5454.1.80.4.1.3.44.0	gigeEth1DSCPSource43	Integer	RW	0-63	0
1.3.6.1.4.1.5454.1.80.4.1.3.45.0	gigeEth1DSCPSource44	Integer	RW	0-63	0
1.3.6.1.4.1.5454.1.80.4.1.3.46.0	gigeEth1DSCPSource45	Integer	RW	0-63	0
1.3.6.1.4.1.5454.1.80.4.1.3.47.0	gigeEth1DSCPSource46	Integer	RW	0-63	0
1.3.6.1.4.1.5454.1.80.4.1.3.48.0	gigeEth1DSCPSource47	Integer	RW	0-63	0
1.3.6.1.4.1.5454.1.80.4.1.3.49.0	gigeEth1DSCPSource48	Integer	RW	0-63	0
1.3.6.1.4.1.5454.1.80.4.1.3.50.0	gigeEth1DSCPSource49	Integer	RW	0-63	0
1.3.6.1.4.1.5454.1.80.4.1.3.51.0	gigeEth1DSCPSource50	Integer	RW	0-63	0
1.3.6.1.4.1.5454.1.80.4.1.3.52.0	gigeEth1DSCPSource51	Integer	RW	0-63	0
1.3.6.1.4.1.5454.1.80.4.1.3.53.0	gigeEth1DSCPSource52	Integer	RW	0-63	0
1.3.6.1.4.1.5454.1.80.4.1.3.54.0	gigeEth1DSCPSource53	Integer	RW	0-63	0
1.3.6.1.4.1.5454.1.80.4.1.3.55.0	gigeEth1DSCPSource54	Integer	RW	0-63	0
1.3.6.1.4.1.5454.1.80.4.1.3.56.0	gigeEth1DSCPSource55	Integer	RW	0-63	0
1.3.6.1.4.1.5454.1.80.4.1.3.57.0	gigeEth1DSCPSource56	Integer	RW	0-63	0
1.3.6.1.4.1.5454.1.80.4.1.3.58.0	gigeEth1DSCPSource57	Integer	RW	0-63	0
1.3.6.1.4.1.5454.1.80.4.1.3.59.0	gigeEth1DSCPSource58	Integer	RW	0-63	0
1.3.6.1.4.1.5454.1.80.4.1.3.60.0	gigeEth1DSCPSource59	Integer	RW	0-63	0
1.3.6.1.4.1.5454.1.80.4.1.3.61.0	gigeEth1DSCPSource60	Integer	RW	0-63	0
1.3.6.1.4.1.5454.1.80.4.1.3.62.0	gigeEth1DSCPSource61	Integer	RW	0-63	0
1.3.6.1.4.1.5454.1.80.4.1.3.63.0	gigeEth1DSCPSource62	Integer	RW	0-63	0
1.3.6.1.4.1.5454.1.80.4.1.3.64.0	gigeEth1DSCPSource63	Integer	RW	0-63	0

Ethernet Section, Contd

1.3.6.1.4.1.5454.1.80.4.2.1.1.0	gigeEth2AutoNegotiate	Integer	RW	0(Off), 1(On)	1(On)
1.3.6.1.4.1.5454.1.80.4.2.1.2.0	gigeEth2Duplex	Integer	RW	0(Half), 1(Full)	1(Full)
1.3.6.1.4.1.5454.1.80.4.2.1.3.0	gigeEth2Enable	Integer	RW	0(Off), 1(On)	1(On)
1.3.6.1.4.1.5454.1.80.4.2.1.4.0	gigeEth2MaxRate	Integer	RW	0-1000	1000
1.3.6.1.4.1.5454.1.80.4.2.1.5.0	gigeEth2PauseFrame	Integer	RW	0(Off), 1(On)	0(Off)
1.3.6.1.4.1.5454.1.80.4.2.1.6.0	gigeEth2Priority	Integer	RW	0-7	0
1.3.6.1.4.1.5454.1.80.4.2.1.7.0	gigeEth2Speed	Integer	RW	0, 100, 1000	1000
1.3.6.1.4.1.5454.1.80.4.2.1.8.0	gigeEth2Status	Integer	RO	0(Off), 1(On)	N/A
1.3.6.1.4.1.5454.1.80.4.2.1.9.0	gigeEth2Loopback	Integer	RW	0(Off), 1(phy), 2(mac)	N/A
1.3.6.1.4.1.5454.1.80.4.2.2.1.0	gigeEth2InOctets	Counter32	RO	0-4294967296	
1.3.6.1.4.1.5454.1.80.4.2.2.2.0	gigeEth2InUcastPackets	Counter32	RO	0-4294967296	
1.3.6.1.4.1.5454.1.80.4.2.2.3.0	gigeEth2InNUcastPackets	Counter32	RO	0-4294967296	
1.3.6.1.4.1.5454.1.80.4.2.2.4.0	gigeEth2InTotalPackets	Counter32	RO	0-4294967296	
1.3.6.1.4.1.5454.1.80.4.2.2.5.0	gigeEth2OutOctets	Counter32	RO	0-4294967296	
1.3.6.1.4.1.5454.1.80.4.2.2.6.0	gigeEth2OutUcastPackets	Counter32	RO	0-4294967296	
1.3.6.1.4.1.5454.1.80.4.2.2.7.0	gigeEth2OutNUcastPackets	Counter32	RO	0-4294967296	
1.3.6.1.4.1.5454.1.80.4.2.2.8.0	gigeEth2OutTotalPackets	Counter32	RO	0-4294967296	
1.3.6.1.4.1.5454.1.80.4.2.2.9.0	gigeEth2CRCErrors	Counter32	RO	0-4294967296	
1.3.6.1.4.1.5454.1.80.4.2.2.10.0	gigeEth2CollisionErrors	Counter32	RO	0-4294967296	
1.3.6.1.4.1.5454.1.80.4.2.2.11.0	gigeEth2InPortRate	Integer	RO	0-400	
1.3.6.1.4.1.5454.1.80.4.2.2.12.0	gigeEth2InPortUtil	Integer	RO	0-100	
1.3.6.1.4.1.5454.1.80.4.2.2.13.0	gigeEth2OutPortRate	Integer	RO	0-400	
1.3.6.1.4.1.5454.1.80.4.2.2.14.0	gigeEth2OutPortUtil	Integer	RO	0-100	
1.3.6.1.4.1.5454.1.80.4.2.3.1.0	gigeEth2DSCPSource0	Integer	RW	0-63	0
1.3.6.1.4.1.5454.1.80.4.2.3.2.0	gigeEth2DSCPSource1	Integer	RW	0-63	0
1.3.6.1.4.1.5454.1.80.4.2.3.3.0	gigeEth2DSCPSource2	Integer	RW	0-63	0
1.3.6.1.4.1.5454.1.80.4.2.3.4.0	gigeEth2DSCPSource3	Integer	RW	0-63	0
1.3.6.1.4.1.5454.1.80.4.2.3.5.0	gigeEth2DSCPSource4	Integer	RW	0-63	0
1.3.6.1.4.1.5454.1.80.4.2.3.6.0	gigeEth2DSCPSource5	Integer	RW	0-63	0
1.3.6.1.4.1.5454.1.80.4.2.3.7.0	gigeEth2DSCPSource6	Integer	RW	0-63	0
1.3.6.1.4.1.5454.1.80.4.2.3.8.0	gigeEth2DSCPSource7	Integer	RW	0-63	0
1.3.6.1.4.1.5454.1.80.4.2.3.9.0	gigeEth2DSCPSource8	Integer	RW	0-63	0
1.3.6.1.4.1.5454.1.80.4.2.3.10.0	gigeEth2DSCPSource9	Integer	RW	0-63	0
1.3.6.1.4.1.5454.1.80.4.2.3.11.0	gigeEth2DSCPSource10	Integer	RW	0-63	0
1.3.6.1.4.1.5454.1.80.4.2.3.12.0	gigeEth2DSCPSource11	Integer	RW	0-63	0
1.3.6.1.4.1.5454.1.80.4.2.3.13.0	gigeEth2DSCPSource12	Integer	RW	0-63	0
1.3.6.1.4.1.5454.1.80.4.2.3.14.0	gigeEth2DSCPSource13	Integer	RW	0-63	0
1.3.6.1.4.1.5454.1.80.4.2.3.15.0	gigeEth2DSCPSource14	Integer	RW	0-63	0
1.3.6.1.4.1.5454.1.80.4.2.3.16.0	gigeEth2DSCPSource15	Integer	RW	0-63	0
1.3.6.1.4.1.5454.1.80.4.2.3.17.0	gigeEth2DSCPSource16	Integer	RW	0-63	0
1.3.6.1.4.1.5454.1.80.4.2.3.18.0	gigeEth2DSCPSource17	Integer	RW	0-63	0
1.3.6.1.4.1.5454.1.80.4.2.3.19.0	gigeEth2DSCPSource18	Integer	RW	0-63	0
1.3.6.1.4.1.5454.1.80.4.2.3.20.0	gigeEth2DSCPSource19	Integer	RW	0-63	0
1.3.6.1.4.1.5454.1.80.4.2.3.21.0	gigeEth2DSCPSource20	Integer	RW	0-63	0
1.3.6.1.4.1.5454.1.80.4.2.3.22.0	gigeEth2DSCPSource21	Integer	RW	0-63	0
1.3.6.1.4.1.5454.1.80.4.2.3.23.0	gigeEth2DSCPSource22	Integer	RW	0-63	0
1.3.6.1.4.1.5454.1.80.4.2.3.24.0	gigeEth2DSCPSource23	Integer	RW	0-63	0
1.3.6.1.4.1.5454.1.80.4.2.3.25.0	gigeEth2DSCPSource24	Integer	RW	0-63	0
1.3.6.1.4.1.5454.1.80.4.2.3.26.0	gigeEth2DSCPSource25	Integer	RW	0-63	0
1.3.6.1.4.1.5454.1.80.4.2.3.27.0	gigeEth2DSCPSource26	Integer	RW	0-63	0
1.3.6.1.4.1.5454.1.80.4.2.3.28.0	gigeEth2DSCPSource27	Integer	RW	0-63	0
1.3.6.1.4.1.5454.1.80.4.2.3.29.0	gigeEth2DSCPSource28	Integer	RW	0-63	0
1.3.6.1.4.1.5454.1.80.4.2.3.30.0	gigeEth2DSCPSource29	Integer	RW	0-63	0
1.3.6.1.4.1.5454.1.80.4.2.3.31.0	gigeEth2DSCPSource30	Integer	RW	0-63	0
1.3.6.1.4.1.5454.1.80.4.2.3.32.0	gigeEth2DSCPSource31	Integer	RW	0-63	0
1.3.6.1.4.1.5454.1.80.4.2.3.33.0	gigeEth2DSCPSource32	Integer	RW	0-63	0
1.3.6.1.4.1.5454.1.80.4.2.3.34.0	gigeEth2DSCPSource33	Integer	RW	0-63	0
1.3.6.1.4.1.5454.1.80.4.2.3.35.0	gigeEth2DSCPSource34	Integer	RW	0-63	0
1.3.6.1.4.1.5454.1.80.4.2.3.36.0	gigeEth2DSCPSource35	Integer	RW	0-63	0
1.3.6.1.4.1.5454.1.80.4.2.3.37.0	gigeEth2DSCPSource36	Integer	RW	0-63	0
1.3.6.1.4.1.5454.1.80.4.2.3.38.0	gigeEth2DSCPSource37	Integer	RW	0-63	0
1.3.6.1.4.1.5454.1.80.4.2.3.39.0	gigeEth2DSCPSource38	Integer	RW	0-63	0
1.3.6.1.4.1.5454.1.80.4.2.3.40.0	gigeEth2DSCPSource39	Integer	RW	0-63	0
1.3.6.1.4.1.5454.1.80.4.2.3.41.0	gigeEth2DSCPSource40	Integer	RW	0-63	0
1.3.6.1.4.1.5454.1.80.4.2.3.42.0	gigeEth2DSCPSource41	Integer	RW	0-63	0
1.3.6.1.4.1.5454.1.80.4.2.3.43.0	gigeEth2DSCPSource42	Integer	RW	0-63	0
1.3.6.1.4.1.5454.1.80.4.2.3.44.0	gigeEth2DSCPSource43	Integer	RW	0-63	0
1.3.6.1.4.1.5454.1.80.4.2.3.45.0	gigeEth2DSCPSource44	Integer	RW	0-63	0
1.3.6.1.4.1.5454.1.80.4.2.3.46.0	gigeEth2DSCPSource45	Integer	RW	0-63	0
1.3.6.1.4.1.5454.1.80.4.2.3.47.0	gigeEth2DSCPSource46	Integer	RW	0-63	0
1.3.6.1.4.1.5454.1.80.4.2.3.48.0	gigeEth2DSCPSource47	Integer	RW	0-63	0
1.3.6.1.4.1.5454.1.80.4.2.3.49.0	gigeEth2DSCPSource48	Integer	RW	0-63	0
1.3.6.1.4.1.5454.1.80.4.2.3.50.0	gigeEth2DSCPSource49	Integer	RW	0-63	0
1.3.6.1.4.1.5454.1.80.4.2.3.51.0	gigeEth2DSCPSource50	Integer	RW	0-63	0
1.3.6.1.4.1.5454.1.80.4.2.3.52.0	gigeEth2DSCPSource51	Integer	RW	0-63	0
1.3.6.1.4.1.5454.1.80.4.2.3.53.0	gigeEth2DSCPSource52	Integer	RW	0-63	0
1.3.6.1.4.1.5454.1.80.4.2.3.54.0	gigeEth2DSCPSource53	Integer	RW	0-63	0
1.3.6.1.4.1.5454.1.80.4.2.3.55.0	gigeEth2DSCPSource54	Integer	RW	0-63	0
1.3.6.1.4.1.5454.1.80.4.2.3.56.0	gigeEth2DSCPSource55	Integer	RW	0-63	0
1.3.6.1.4.1.5454.1.80.4.2.3.57.0	gigeEth2DSCPSource56	Integer	RW	0-63	0
1.3.6.1.4.1.5454.1.80.4.2.3.58.0	gigeEth2DSCPSource57	Integer	RW	0-63	0
1.3.6.1.4.1.5454.1.80.4.2.3.59.0	gigeEth2DSCPSource58	Integer	RW	0-63	0
1.3.6.1.4.1.5454.1.80.4.2.3.60.0	gigeEth2DSCPSource59	Integer	RW	0-63	0
1.3.6.1.4.1.5454.1.80.4.2.3.61.0	gigeEth2DSCPSource60	Integer	RW	0-63	0
1.3.6.1.4.1.5454.1.80.4.2.3.62.0	gigeEth2DSCPSource61	Integer	RW	0-63	0
1.3.6.1.4.1.5454.1.80.4.2.3.63.0	gigeEth2DSCPSource62	Integer	RW	0-63	0
1.3.6.1.4.1.5454.1.80.4.2.3.64.0	gigeEth2DSCPSource63	Integer	RW	0-63	0

Ethernet Section, Contd

1.3.6.1.4.1.5454.1.80.4.3.1.1.0	gigeEth3AutoNegotiate	Integer	RW	0(Off), 1(On)	1(On)
1.3.6.1.4.1.5454.1.80.4.3.1.2.0	gigeEth3Duplex	Integer	RW	0(Half), 1(Full)	1(Full)
1.3.6.1.4.1.5454.1.80.4.3.1.3.0	gigeEth3Enable	Integer	RW	0(Off), 1(On)	1(On)
1.3.6.1.4.1.5454.1.80.4.3.1.4.0	gigeEth3MaxRate	Integer	RW	0-1000	1000
1.3.6.1.4.1.5454.1.80.4.3.1.5.0	gigeEth3PauseFrame	Integer	RW	0(Off), 1(On)	0(Off)
1.3.6.1.4.1.5454.1.80.4.3.1.6.0	gigeEth3Priority	Integer	RW	0-7	0
1.3.6.1.4.1.5454.1.80.4.3.1.7.0	gigeEth3Speed	Integer	RW	0, 100, 1000	1000
1.3.6.1.4.1.5454.1.80.4.3.1.8.0	gigeEth3Status	Integer	RO	0(Off), 1(On)	N/A
1.3.6.1.4.1.5454.1.80.4.3.1.9.0	gigeEth3Loopback	Integer	RW	0(Off), 1(phy), 2(mac)	N/A
1.3.6.1.4.1.5454.1.80.4.3.2.1.0	gigeEth3InOctets	Counter32	RO	0-4294967296	N/A
1.3.6.1.4.1.5454.1.80.4.3.2.2.0	gigeEth3InUcastPackets	Counter32	RO	0-4294967296	N/A
1.3.6.1.4.1.5454.1.80.4.3.2.3.0	gigeEth3InMcastPackets	Counter32	RO	0-4294967296	N/A
1.3.6.1.4.1.5454.1.80.4.3.2.4.0	gigeEth3InTotalPackets	Counter32	RO	0-4294967296	N/A
1.3.6.1.4.1.5454.1.80.4.3.2.5.0	gigeEth3OutOctets	Counter32	RO	0-4294967296	N/A
1.3.6.1.4.1.5454.1.80.4.3.2.6.0	gigeEth3OutUcastPackets	Counter32	RO	0-4294967296	N/A
1.3.6.1.4.1.5454.1.80.4.3.2.7.0	gigeEth3OutMcastPackets	Counter32	RO	0-4294967296	N/A
1.3.6.1.4.1.5454.1.80.4.3.2.8.0	gigeEth3OutTotalPackets	Counter32	RO	0-4294967296	N/A
1.3.6.1.4.1.5454.1.80.4.3.2.9.0	gigeEth3CRCERrors	Counter32	RO	0-4294967296	N/A
1.3.6.1.4.1.5454.1.80.4.3.2.10.0	gigeEth3CollisionErrors	Counter32	RO	0-4294967296	N/A
1.3.6.1.4.1.5454.1.80.4.3.2.11.0	gigeEth3InPortRate	Integer	RO	0-400	
1.3.6.1.4.1.5454.1.80.4.3.2.12.0	gigeEth3InPortUtil	Integer	RO	0-100	
1.3.6.1.4.1.5454.1.80.4.3.2.13.0	gigeEth3OutPortRate	Integer	RO	0-400	
1.3.6.1.4.1.5454.1.80.4.3.2.14.0	gigeEth3OutPortUtil	Integer	RO	0-100	
1.3.6.1.4.1.5454.1.80.4.3.3.1.0	gigeEth3DSCPSrc0	Integer	RW	0-63	0
1.3.6.1.4.1.5454.1.80.4.3.3.2.0	gigeEth3DSCPSrc1	Integer	RW	0-63	0
1.3.6.1.4.1.5454.1.80.4.3.3.3.0	gigeEth3DSCPSrc2	Integer	RW	0-63	0
1.3.6.1.4.1.5454.1.80.4.3.3.4.0	gigeEth3DSCPSrc3	Integer	RW	0-63	0
1.3.6.1.4.1.5454.1.80.4.3.3.5.0	gigeEth3DSCPSrc4	Integer	RW	0-63	0
1.3.6.1.4.1.5454.1.80.4.3.3.6.0	gigeEth3DSCPSrc5	Integer	RW	0-63	0
1.3.6.1.4.1.5454.1.80.4.3.3.7.0	gigeEth3DSCPSrc6	Integer	RW	0-63	0
1.3.6.1.4.1.5454.1.80.4.3.3.8.0	gigeEth3DSCPSrc7	Integer	RW	0-63	0
1.3.6.1.4.1.5454.1.80.4.3.3.9.0	gigeEth3DSCPSrc8	Integer	RW	0-63	0
1.3.6.1.4.1.5454.1.80.4.3.3.10.0	gigeEth3DSCPSrc9	Integer	RW	0-63	0
1.3.6.1.4.1.5454.1.80.4.3.3.11.0	gigeEth3DSCPSrc10	Integer	RW	0-63	0
1.3.6.1.4.1.5454.1.80.4.3.3.12.0	gigeEth3DSCPSrc11	Integer	RW	0-63	0
1.3.6.1.4.1.5454.1.80.4.3.3.13.0	gigeEth3DSCPSrc12	Integer	RW	0-63	0
1.3.6.1.4.1.5454.1.80.4.3.3.14.0	gigeEth3DSCPSrc13	Integer	RW	0-63	0
1.3.6.1.4.1.5454.1.80.4.3.3.15.0	gigeEth3DSCPSrc14	Integer	RW	0-63	0
1.3.6.1.4.1.5454.1.80.4.3.3.16.0	gigeEth3DSCPSrc15	Integer	RW	0-63	0
1.3.6.1.4.1.5454.1.80.4.3.3.17.0	gigeEth3DSCPSrc16	Integer	RW	0-63	0
1.3.6.1.4.1.5454.1.80.4.3.3.18.0	gigeEth3DSCPSrc17	Integer	RW	0-63	0
1.3.6.1.4.1.5454.1.80.4.3.3.19.0	gigeEth3DSCPSrc18	Integer	RW	0-63	0
1.3.6.1.4.1.5454.1.80.4.3.3.20.0	gigeEth3DSCPSrc19	Integer	RW	0-63	0
1.3.6.1.4.1.5454.1.80.4.3.3.21.0	gigeEth3DSCPSrc20	Integer	RW	0-63	0
1.3.6.1.4.1.5454.1.80.4.3.3.22.0	gigeEth3DSCPSrc21	Integer	RW	0-63	0
1.3.6.1.4.1.5454.1.80.4.3.3.23.0	gigeEth3DSCPSrc22	Integer	RW	0-63	0
1.3.6.1.4.1.5454.1.80.4.3.3.24.0	gigeEth3DSCPSrc23	Integer	RW	0-63	0
1.3.6.1.4.1.5454.1.80.4.3.3.25.0	gigeEth3DSCPSrc24	Integer	RW	0-63	0
1.3.6.1.4.1.5454.1.80.4.3.3.26.0	gigeEth3DSCPSrc25	Integer	RW	0-63	0
1.3.6.1.4.1.5454.1.80.4.3.3.27.0	gigeEth3DSCPSrc26	Integer	RW	0-63	0
1.3.6.1.4.1.5454.1.80.4.3.3.28.0	gigeEth3DSCPSrc27	Integer	RW	0-63	0
1.3.6.1.4.1.5454.1.80.4.3.3.29.0	gigeEth3DSCPSrc28	Integer	RW	0-63	0
1.3.6.1.4.1.5454.1.80.4.3.3.30.0	gigeEth3DSCPSrc29	Integer	RW	0-63	0
1.3.6.1.4.1.5454.1.80.4.3.3.31.0	gigeEth3DSCPSrc30	Integer	RW	0-63	0
1.3.6.1.4.1.5454.1.80.4.3.3.32.0	gigeEth3DSCPSrc31	Integer	RW	0-63	0
1.3.6.1.4.1.5454.1.80.4.3.3.33.0	gigeEth3DSCPSrc32	Integer	RW	0-63	0
1.3.6.1.4.1.5454.1.80.4.3.3.34.0	gigeEth3DSCPSrc33	Integer	RW	0-63	0
1.3.6.1.4.1.5454.1.80.4.3.3.35.0	gigeEth3DSCPSrc34	Integer	RW	0-63	0
1.3.6.1.4.1.5454.1.80.4.3.3.36.0	gigeEth3DSCPSrc35	Integer	RW	0-63	0
1.3.6.1.4.1.5454.1.80.4.3.3.37.0	gigeEth3DSCPSrc36	Integer	RW	0-63	0
1.3.6.1.4.1.5454.1.80.4.3.3.38.0	gigeEth3DSCPSrc37	Integer	RW	0-63	0
1.3.6.1.4.1.5454.1.80.4.3.3.39.0	gigeEth3DSCPSrc38	Integer	RW	0-63	0
1.3.6.1.4.1.5454.1.80.4.3.3.40.0	gigeEth3DSCPSrc39	Integer	RW	0-63	0
1.3.6.1.4.1.5454.1.80.4.3.3.41.0	gigeEth3DSCPSrc40	Integer	RW	0-63	0
1.3.6.1.4.1.5454.1.80.4.3.3.42.0	gigeEth3DSCPSrc41	Integer	RW	0-63	0
1.3.6.1.4.1.5454.1.80.4.3.3.43.0	gigeEth3DSCPSrc42	Integer	RW	0-63	0
1.3.6.1.4.1.5454.1.80.4.3.3.44.0	gigeEth3DSCPSrc43	Integer	RW	0-63	0
1.3.6.1.4.1.5454.1.80.4.3.3.45.0	gigeEth3DSCPSrc44	Integer	RW	0-63	0
1.3.6.1.4.1.5454.1.80.4.3.3.46.0	gigeEth3DSCPSrc45	Integer	RW	0-63	0
1.3.6.1.4.1.5454.1.80.4.3.3.47.0	gigeEth3DSCPSrc46	Integer	RW	0-63	0
1.3.6.1.4.1.5454.1.80.4.3.3.48.0	gigeEth3DSCPSrc47	Integer	RW	0-63	0
1.3.6.1.4.1.5454.1.80.4.3.3.49.0	gigeEth3DSCPSrc48	Integer	RW	0-63	0
1.3.6.1.4.1.5454.1.80.4.3.3.50.0	gigeEth3DSCPSrc49	Integer	RW	0-63	0
1.3.6.1.4.1.5454.1.80.4.3.3.51.0	gigeEth3DSCPSrc50	Integer	RW	0-63	0
1.3.6.1.4.1.5454.1.80.4.3.3.52.0	gigeEth3DSCPSrc51	Integer	RW	0-63	0
1.3.6.1.4.1.5454.1.80.4.3.3.53.0	gigeEth3DSCPSrc52	Integer	RW	0-63	0
1.3.6.1.4.1.5454.1.80.4.3.3.54.0	gigeEth3DSCPSrc53	Integer	RW	0-63	0
1.3.6.1.4.1.5454.1.80.4.3.3.55.0	gigeEth3DSCPSrc54	Integer	RW	0-63	0
1.3.6.1.4.1.5454.1.80.4.3.3.56.0	gigeEth3DSCPSrc55	Integer	RW	0-63	0
1.3.6.1.4.1.5454.1.80.4.3.3.57.0	gigeEth3DSCPSrc56	Integer	RW	0-63	0
1.3.6.1.4.1.5454.1.80.4.3.3.58.0	gigeEth3DSCPSrc57	Integer	RW	0-63	0
1.3.6.1.4.1.5454.1.80.4.3.3.59.0	gigeEth3DSCPSrc58	Integer	RW	0-63	0
1.3.6.1.4.1.5454.1.80.4.3.3.60.0	gigeEth3DSCPSrc59	Integer	RW	0-63	0
1.3.6.1.4.1.5454.1.80.4.3.3.61.0	gigeEth3DSCPSrc60	Integer	RW	0-63	0
1.3.6.1.4.1.5454.1.80.4.3.3.62.0	gigeEth3DSCPSrc61	Integer	RW	0-63	0
1.3.6.1.4.1.5454.1.80.4.3.3.63.0	gigeEth3DSCPSrc62	Integer	RW	0-63	0
1.3.6.1.4.1.5454.1.80.4.3.3.64.0	gigeEth3DSCPSrc63	Integer	RW	0-63	0

Ethernet Section, Contd

1.3.6.1.4.1.5454.1.80.4.4.1.1.0	gigeEth4AutoNegotiate	Integer	RW	0(Off), 1(On)	1(On)
1.3.6.1.4.1.5454.1.80.4.4.1.2.0	gigeEth4Duplex	Integer	RW	0(Half), 1(Full)	1(Full)
1.3.6.1.4.1.5454.1.80.4.4.1.3.0	gigeEth4Enable	Integer	RW	0(Off), 1(On)	1(On)
1.3.6.1.4.1.5454.1.80.4.4.1.4.0	gigeEth4MaxRate	Integer	RW	0-1000	1000
1.3.6.1.4.1.5454.1.80.4.4.1.5.0	gigeEth4PauseFrame	Integer	RW	0(Off), 1(On)	0(Off)
1.3.6.1.4.1.5454.1.80.4.4.1.6.0	gigeEth4Priority	Integer	RW	0-7	0
1.3.6.1.4.1.5454.1.80.4.4.1.7.0	gigeEth4Speed	Integer	RW	0, 100, 1000	1000
1.3.6.1.4.1.5454.1.80.4.4.1.8.0	gigeEth4Status	Integer	RO	0(Off), 1(On)	N/A
1.3.6.1.4.1.5454.1.80.4.4.1.9.0	gigeEth4Loopback	Integer	RW	0(Off), 1(phy), 2(mac)	N/A
1.3.6.1.4.1.5454.1.80.4.4.2.1.0	gigeEth4InOctets	Counter32	RO	0-4294967296	N/A
1.3.6.1.4.1.5454.1.80.4.4.2.2.0	gigeEth4InUcastPackets	Counter32	RO	0-4294967296	N/A
1.3.6.1.4.1.5454.1.80.4.4.2.3.0	gigeEth4InNUcastPackets	Counter32	RO	0-4294967296	N/A
1.3.6.1.4.1.5454.1.80.4.4.2.4.0	gigeEth4InTotalPackets	Counter32	RO	0-4294967296	N/A
1.3.6.1.4.1.5454.1.80.4.4.2.5.0	gigeEth4OutOctets	Counter32	RO	0-4294967296	N/A
1.3.6.1.4.1.5454.1.80.4.4.2.6.0	gigeEth4OutUcastPackets	Counter32	RO	0-4294967296	N/A
1.3.6.1.4.1.5454.1.80.4.4.2.7.0	gigeEth4OutNUcastPackets	Counter32	RO	0-4294967296	N/A
1.3.6.1.4.1.5454.1.80.4.4.2.8.0	gigeEth4OutTotalPackets	Counter32	RO	0-4294967296	N/A
1.3.6.1.4.1.5454.1.80.4.4.2.9.0	gigeEth4CRCErrors	Counter32	RO	0-4294967296	N/A
1.3.6.1.4.1.5454.1.80.4.4.2.10.0	gigeEth4CollisionErrors	Counter32	RO	0-4294967296	N/A
1.3.6.1.4.1.5454.1.80.4.4.2.11.0	gigeEth4InPortRate	Integer	RO	0-400	
1.3.6.1.4.1.5454.1.80.4.4.2.12.0	gigeEth4InPortUtil	Integer	RO	0-100	
1.3.6.1.4.1.5454.1.80.4.4.2.13.0	gigeEth4OutPortRate	Integer	RO	0-400	
1.3.6.1.4.1.5454.1.80.4.4.2.14.0	gigeEth4OutPortUtil	Integer	RO	0-100	
1.3.6.1.4.1.5454.1.80.4.4.3.1.0	gigeEth4DSCPSource0	Integer	RW	0-63	0
1.3.6.1.4.1.5454.1.80.4.4.3.2.0	gigeEth4DSCPSource1	Integer	RW	0-63	0
1.3.6.1.4.1.5454.1.80.4.4.3.3.0	gigeEth4DSCPSource2	Integer	RW	0-63	0
1.3.6.1.4.1.5454.1.80.4.4.3.4.0	gigeEth4DSCPSource3	Integer	RW	0-63	0
1.3.6.1.4.1.5454.1.80.4.4.3.5.0	gigeEth4DSCPSource4	Integer	RW	0-63	0
1.3.6.1.4.1.5454.1.80.4.4.3.6.0	gigeEth4DSCPSource5	Integer	RW	0-63	0
1.3.6.1.4.1.5454.1.80.4.4.3.7.0	gigeEth4DSCPSource6	Integer	RW	0-63	0
1.3.6.1.4.1.5454.1.80.4.4.3.8.0	gigeEth4DSCPSource7	Integer	RW	0-63	0
1.3.6.1.4.1.5454.1.80.4.4.3.9.0	gigeEth4DSCPSource8	Integer	RW	0-63	0
1.3.6.1.4.1.5454.1.80.4.4.3.10.0	gigeEth4DSCPSource9	Integer	RW	0-63	0
1.3.6.1.4.1.5454.1.80.4.4.3.11.0	gigeEth4DSCPSource10	Integer	RW	0-63	0
1.3.6.1.4.1.5454.1.80.4.4.3.12.0	gigeEth4DSCPSource11	Integer	RW	0-63	0
1.3.6.1.4.1.5454.1.80.4.4.3.13.0	gigeEth4DSCPSource12	Integer	RW	0-63	0
1.3.6.1.4.1.5454.1.80.4.4.3.14.0	gigeEth4DSCPSource13	Integer	RW	0-63	0
1.3.6.1.4.1.5454.1.80.4.4.3.15.0	gigeEth4DSCPSource14	Integer	RW	0-63	0
1.3.6.1.4.1.5454.1.80.4.4.3.16.0	gigeEth4DSCPSource15	Integer	RW	0-63	0
1.3.6.1.4.1.5454.1.80.4.4.3.17.0	gigeEth4DSCPSource16	Integer	RW	0-63	0
1.3.6.1.4.1.5454.1.80.4.4.3.18.0	gigeEth4DSCPSource17	Integer	RW	0-63	0
1.3.6.1.4.1.5454.1.80.4.4.3.19.0	gigeEth4DSCPSource18	Integer	RW	0-63	0
1.3.6.1.4.1.5454.1.80.4.4.3.20.0	gigeEth4DSCPSource19	Integer	RW	0-63	0
1.3.6.1.4.1.5454.1.80.4.4.3.21.0	gigeEth4DSCPSource20	Integer	RW	0-63	0
1.3.6.1.4.1.5454.1.80.4.4.3.22.0	gigeEth4DSCPSource21	Integer	RW	0-63	0
1.3.6.1.4.1.5454.1.80.4.4.3.23.0	gigeEth4DSCPSource22	Integer	RW	0-63	0
1.3.6.1.4.1.5454.1.80.4.4.3.24.0	gigeEth4DSCPSource23	Integer	RW	0-63	0
1.3.6.1.4.1.5454.1.80.4.4.3.25.0	gigeEth4DSCPSource24	Integer	RW	0-63	0
1.3.6.1.4.1.5454.1.80.4.4.3.26.0	gigeEth4DSCPSource25	Integer	RW	0-63	0
1.3.6.1.4.1.5454.1.80.4.4.3.27.0	gigeEth4DSCPSource26	Integer	RW	0-63	0
1.3.6.1.4.1.5454.1.80.4.4.3.28.0	gigeEth4DSCPSource27	Integer	RW	0-63	0
1.3.6.1.4.1.5454.1.80.4.4.3.29.0	gigeEth4DSCPSource28	Integer	RW	0-63	0
1.3.6.1.4.1.5454.1.80.4.4.3.30.0	gigeEth4DSCPSource29	Integer	RW	0-63	0
1.3.6.1.4.1.5454.1.80.4.4.3.31.0	gigeEth4DSCPSource30	Integer	RW	0-63	0
1.3.6.1.4.1.5454.1.80.4.4.3.32.0	gigeEth4DSCPSource31	Integer	RW	0-63	0
1.3.6.1.4.1.5454.1.80.4.4.3.33.0	gigeEth4DSCPSource32	Integer	RW	0-63	0
1.3.6.1.4.1.5454.1.80.4.4.3.34.0	gigeEth4DSCPSource33	Integer	RW	0-63	0
1.3.6.1.4.1.5454.1.80.4.4.3.35.0	gigeEth4DSCPSource34	Integer	RW	0-63	0
1.3.6.1.4.1.5454.1.80.4.4.3.36.0	gigeEth4DSCPSource35	Integer	RW	0-63	0
1.3.6.1.4.1.5454.1.80.4.4.3.37.0	gigeEth4DSCPSource36	Integer	RW	0-63	0
1.3.6.1.4.1.5454.1.80.4.4.3.38.0	gigeEth4DSCPSource37	Integer	RW	0-63	0
1.3.6.1.4.1.5454.1.80.4.4.3.39.0	gigeEth4DSCPSource38	Integer	RW	0-63	0
1.3.6.1.4.1.5454.1.80.4.4.3.40.0	gigeEth4DSCPSource39	Integer	RW	0-63	0
1.3.6.1.4.1.5454.1.80.4.4.3.41.0	gigeEth4DSCPSource40	Integer	RW	0-63	0
1.3.6.1.4.1.5454.1.80.4.4.3.42.0	gigeEth4DSCPSource41	Integer	RW	0-63	0
1.3.6.1.4.1.5454.1.80.4.4.3.43.0	gigeEth4DSCPSource42	Integer	RW	0-63	0
1.3.6.1.4.1.5454.1.80.4.4.3.44.0	gigeEth4DSCPSource43	Integer	RW	0-63	0
1.3.6.1.4.1.5454.1.80.4.4.3.45.0	gigeEth4DSCPSource44	Integer	RW	0-63	0
1.3.6.1.4.1.5454.1.80.4.4.3.46.0	gigeEth4DSCPSource45	Integer	RW	0-63	0
1.3.6.1.4.1.5454.1.80.4.4.3.47.0	gigeEth4DSCPSource46	Integer	RW	0-63	0
1.3.6.1.4.1.5454.1.80.4.4.3.48.0	gigeEth4DSCPSource47	Integer	RW	0-63	0
1.3.6.1.4.1.5454.1.80.4.4.3.49.0	gigeEth4DSCPSource48	Integer	RW	0-63	0
1.3.6.1.4.1.5454.1.80.4.4.3.50.0	gigeEth4DSCPSource49	Integer	RW	0-63	0
1.3.6.1.4.1.5454.1.80.4.4.3.51.0	gigeEth4DSCPSource50	Integer	RW	0-63	0
1.3.6.1.4.1.5454.1.80.4.4.3.52.0	gigeEth4DSCPSource51	Integer	RW	0-63	0
1.3.6.1.4.1.5454.1.80.4.4.3.53.0	gigeEth4DSCPSource52	Integer	RW	0-63	0
1.3.6.1.4.1.5454.1.80.4.4.3.54.0	gigeEth4DSCPSource53	Integer	RW	0-63	0
1.3.6.1.4.1.5454.1.80.4.4.3.55.0	gigeEth4DSCPSource54	Integer	RW	0-63	0
1.3.6.1.4.1.5454.1.80.4.4.3.56.0	gigeEth4DSCPSource55	Integer	RW	0-63	0
1.3.6.1.4.1.5454.1.80.4.4.3.57.0	gigeEth4DSCPSource56	Integer	RW	0-63	0
1.3.6.1.4.1.5454.1.80.4.4.3.58.0	gigeEth4DSCPSource57	Integer	RW	0-63	0
1.3.6.1.4.1.5454.1.80.4.4.3.59.0	gigeEth4DSCPSource58	Integer	RW	0-63	0
1.3.6.1.4.1.5454.1.80.4.4.3.60.0	gigeEth4DSCPSource59	Integer	RW	0-63	0
1.3.6.1.4.1.5454.1.80.4.4.3.61.0	gigeEth4DSCPSource60	Integer	RW	0-63	0
1.3.6.1.4.1.5454.1.80.4.4.3.62.0	gigeEth4DSCPSource61	Integer	RW	0-63	0
1.3.6.1.4.1.5454.1.80.4.4.3.63.0	gigeEth4DSCPSource62	Integer	RW	0-63	0
1.3.6.1.4.1.5454.1.80.4.4.3.64.0	gigeEth4DSCPSource63	Integer	RW	0-63	0

Ethernet Section, Contd

.1.3.6.1.4.1.5454.1.80.4.5.1.0	gigeEthCOSQueue	Integer	RW	0-3	0
.1.3.6.1.4.1.5454.1.80.4.5.2.0	gigeEthPriority1COSQueue	Integer	RW	0-3	0
.1.3.6.1.4.1.5454.1.80.4.5.3.0	gigeEthPriority2COSQueue	Integer	RW	0-3	1
.1.3.6.1.4.1.5454.1.80.4.5.4.0	gigeEthPriority3COSQueue	Integer	RW	0-3	1
.1.3.6.1.4.1.5454.1.80.4.5.5.0	gigeEthPriority4COSQueue	Integer	RW	0-3	2
.1.3.6.1.4.1.5454.1.80.4.5.6.0	gigeEthPriority5COSQueue	Integer	RW	0-3	2
.1.3.6.1.4.1.5454.1.80.4.5.7.0	gigeEthPriority6COSQueue	Integer	RW	0-3	3
.1.3.6.1.4.1.5454.1.80.4.5.8.0	gigeEthPriority7COSQueue	Integer	RW	0-3	3
.1.3.6.1.4.1.5454.1.80.4.6.1.0	gigeEthPriority0DSCPWeight	Integer	RW	0-15	0
.1.3.6.1.4.1.5454.1.80.4.6.2.0	gigeEthPriority1DSCPWeight	Integer	RW	0-15	0
.1.3.6.1.4.1.5454.1.80.4.6.3.0	gigeEthPriority2DSCPWeight	Integer	RW	0-15	0
.1.3.6.1.4.1.5454.1.80.4.6.4.0	gigeEthPriority3DSCPWeight	Integer	RW	0-15	0
.1.3.6.1.4.1.5454.1.80.4.6.5.0	gigeEthPriority4DSCPWeight	Integer	RW	0-15	0
.1.3.6.1.4.1.5454.1.80.4.6.6.0	gigeEthPriority5DSCPWeight	Integer	RW	0-15	0
.1.3.6.1.4.1.5454.1.80.4.6.7.0	gigeEthPriority6DSCPWeight	Integer	RW	0-15	0
.1.3.6.1.4.1.5454.1.80.4.6.8.0	gigeEthPriority7DSCPWeight	Integer	RW	0-15	0

TDM Section

Object ID	Name		Access	Range Limit	Default Value
.1.3.6.1.4.1.5454.1.80.5.1.1.1	tdmPort1Status	Integer	RO	0(Off), 1(On)	0(Off)
.1.3.6.1.4.1.5454.1.80.5.1.1.2	tdmPort1CableConfig	Integer	RO	0(0-133), 1(133-266), 2(255-399), 3(399-533), 4(533-655)	0(0-133)
.1.3.6.1.4.1.5454.1.80.5.1.2.1	tdmPort1CounterCrcBlockErrors	Counter32	RO	0-4294967296	N/A
.1.3.6.1.4.1.5454.1.80.5.1.2.2	tdmPort1CounterExCrcErrors	Counter32	RO	0-4294967296	N/A
.1.3.6.1.4.1.5454.1.80.5.1.2.3	tdmPort1CounterFBAErrors	Counter32	RO	0-4294967296	N/A
.1.3.6.1.4.1.5454.1.80.5.1.2.4	tdmPort1CounterFEBErrors	Counter32	RO	0-4294967296	N/A
.1.3.6.1.4.1.5454.1.80.5.1.2.5	tdmPort1CounterLCViolations	Counter32	RO	0-4294967296	N/A
.1.3.6.1.4.1.5454.1.80.5.1.3.1	tdmPort1EventLOS	Counter32	RO	0-4294967296	N/A
.1.3.6.1.4.1.5454.1.80.5.1.3.2	tdmPort1EventLOF	Counter32	RO	0-4294967296	N/A
.1.3.6.1.4.1.5454.1.80.5.1.3.3	tdmPort1EventAIS	Counter32	RO	0-4294967296	N/A
.1.3.6.1.4.1.5454.1.80.5.1.3.4	tdmPort1EventTS16AIS	Counter32	RO	0-4294967296	N/A
.1.3.6.1.4.1.5454.1.80.5.1.3.5	tdmPort1EventRAI	Counter32	RO	0-4294967296	N/A
.1.3.6.1.4.1.5454.1.80.5.1.3.6	tdmPort1EventLCMFA	Counter32	RO	0-4294967296	N/A
.1.3.6.1.4.1.5454.1.80.5.1.3.7	tdmPort1EventLSMFA	Counter32	RO	0-4294967296	N/A
.1.3.6.1.4.1.5454.1.80.5.2.1.1	tdmPort2Status	Integer	RO	0(Off), 1(On)	0(Off)
.1.3.6.1.4.1.5454.1.80.5.2.1.2	tdmPort2CableConfig	Integer	RO	0(0-133), 1(133-266), 2(255-399), 3(399-533), 4(533-655)	0(0-133)
.1.3.6.1.4.1.5454.1.80.5.2.2.1	tdmPort2CounterCrcBlockErrors	Counter32	RO	0-4294967296	N/A
.1.3.6.1.4.1.5454.1.80.5.2.2.2	tdmPort2CounterExCrcErrors	Counter32	RO	0-4294967296	N/A
.1.3.6.1.4.1.5454.1.80.5.2.2.3	tdmPort2CounterFBAErrors	Counter32	RO	0-4294967296	N/A
.1.3.6.1.4.1.5454.1.80.5.2.2.4	tdmPort2CounterFEBErrors	Counter32	RO	0-4294967296	N/A
.1.3.6.1.4.1.5454.1.80.5.2.2.5	tdmPort2CounterLCViolations	Counter32	RO	0-4294967296	N/A
.1.3.6.1.4.1.5454.1.80.5.2.3.1	tdmPort2EventLOS	Counter32	RO	0-4294967296	N/A
.1.3.6.1.4.1.5454.1.80.5.2.3.2	tdmPort2EventLOF	Counter32	RO	0-4294967296	N/A
.1.3.6.1.4.1.5454.1.80.5.2.3.3	tdmPort2EventAIS	Counter32	RO	0-4294967296	N/A
.1.3.6.1.4.1.5454.1.80.5.2.3.4	tdmPort2EventTS16AIS	Counter32	RO	0-4294967296	N/A
.1.3.6.1.4.1.5454.1.80.5.2.3.5	tdmPort2EventRAI	Counter32	RO	0-4294967296	N/A
.1.3.6.1.4.1.5454.1.80.5.2.3.6	tdmPort2EventLCMFA	Counter32	RO	0-4294967296	N/A
.1.3.6.1.4.1.5454.1.80.5.2.3.7	tdmPort2EventLSMFA	Counter32	RO	0-4294967296	N/A
.1.3.6.1.4.1.5454.1.80.5.3.1.1	tdmPort3Status	Integer	RO	0(Off), 1(On)	0(Off)
.1.3.6.1.4.1.5454.1.80.5.3.1.2	tdmPort3CableConfig	Integer	RO	0(0-133), 1(133-266), 2(255-399), 3(399-533), 4(533-655)	0(0-133)
.1.3.6.1.4.1.5454.1.80.5.3.2.1	tdmPort3CounterCrcBlockErrors	Counter32	RO	0-4294967296	N/A
.1.3.6.1.4.1.5454.1.80.5.3.2.2	tdmPort3CounterExCrcErrors	Counter32	RO	0-4294967296	N/A
.1.3.6.1.4.1.5454.1.80.5.3.2.3	tdmPort3CounterFBAErrors	Counter32	RO	0-4294967296	N/A
.1.3.6.1.4.1.5454.1.80.5.3.2.4	tdmPort3CounterFEBErrors	Counter32	RO	0-4294967296	N/A
.1.3.6.1.4.1.5454.1.80.5.3.2.5	tdmPort3CounterLCViolations	Counter32	RO	0-4294967296	N/A
.1.3.6.1.4.1.5454.1.80.5.3.3.1	tdmPort3EventLOS	Counter32	RO	0-4294967296	N/A
.1.3.6.1.4.1.5454.1.80.5.3.3.2	tdmPort3EventLOF	Counter32	RO	0-4294967296	N/A
.1.3.6.1.4.1.5454.1.80.5.3.3.3	tdmPort3EventAIS	Counter32	RO	0-4294967296	N/A
.1.3.6.1.4.1.5454.1.80.5.3.3.4	tdmPort3EventTS16AIS	Counter32	RO	0-4294967296	N/A
.1.3.6.1.4.1.5454.1.80.5.3.3.5	tdmPort3EventRAI	Counter32	RO	0-4294967296	N/A
.1.3.6.1.4.1.5454.1.80.5.3.3.6	tdmPort3EventLCMFA	Counter32	RO	0-4294967296	N/A
.1.3.6.1.4.1.5454.1.80.5.3.3.7	tdmPort3EventLSMFA	Counter32	RO	0-4294967296	N/A

TDM Section, Cont'd

.1.3.6.1.4.1.5454.1.80.5.4.1.1	tdmPort4Status	Integer	RO	0(Off), 1(On)	0(Off)
.1.3.6.1.4.1.5454.1.80.5.4.1.2	tdmPort4CableConfig	Integer	RO	0(0-133), 1(133-266), 2(255-399), 3(399-533), 4(533-655)	0(0-133)
.1.3.6.1.4.1.5454.1.80.5.4.2.1	tdmPort4CounterCrcBlockErrors	Counter32	RO	0-4294967296	N/A
.1.3.6.1.4.1.5454.1.80.5.4.2.2	tdmPort4CounterExCrcErrors	Counter32	RO	0-4294967296	N/A
.1.3.6.1.4.1.5454.1.80.5.4.2.3	tdmPort4CounterFBAErrors	Counter32	RO	0-4294967296	N/A
.1.3.6.1.4.1.5454.1.80.5.4.2.4	tdmPort4CounterFEBErrors	Counter32	RO	0-4294967296	N/A
.1.3.6.1.4.1.5454.1.80.5.4.2.5	tdmPort4CounterLCViolations	Counter32	RO	0-4294967296	N/A
.1.3.6.1.4.1.5454.1.80.5.4.3.1	tdmPort4EventLOS	Counter32	RO	0-4294967296	N/A
.1.3.6.1.4.1.5454.1.80.5.4.3.2	tdmPort4EventLOF	Counter32	RO	0-4294967296	N/A
.1.3.6.1.4.1.5454.1.80.5.4.3.3	tdmPort4EventAIS	Counter32	RO	0-4294967296	N/A
.1.3.6.1.4.1.5454.1.80.5.4.3.4	tdmPort4EventTS16AIS	Counter32	RO	0-4294967296	N/A
.1.3.6.1.4.1.5454.1.80.5.4.3.5	tdmPort4EventRAI	Counter32	RO	0-4294967296	N/A
.1.3.6.1.4.1.5454.1.80.5.4.3.6	tdmPort4EventLCMFA	Counter32	RO	0-4294967296	N/A
.1.3.6.1.4.1.5454.1.80.5.4.3.7	tdmPort4EventLSMFA	Counter32	RO	0-4294967296	N/A
.1.3.6.1.4.1.5454.1.80.5.5.1.1	tdmPort5Status	Integer	RO	0(Off), 1(On)	0(Off)
.1.3.6.1.4.1.5454.1.80.5.5.1.2	tdmPort5CableConfig	Integer	RO	0(0-133), 1(133-266), 2(255-399), 3(399-533), 4(533-655)	0(0-133)
.1.3.6.1.4.1.5454.1.80.5.5.2.1	tdmPort5CounterCrcBlockErrors	Counter32	RO	0-4294967296	N/A
.1.3.6.1.4.1.5454.1.80.5.5.2.2	tdmPort5CounterExCrcErrors	Counter32	RO	0-4294967296	N/A
.1.3.6.1.4.1.5454.1.80.5.5.2.3	tdmPort5CounterFBAErrors	Counter32	RO	0-4294967296	N/A
.1.3.6.1.4.1.5454.1.80.5.5.2.4	tdmPort5CounterFEBErrors	Counter32	RO	0-4294967296	N/A
.1.3.6.1.4.1.5454.1.80.5.5.2.5	tdmPort5CounterLCViolations	Counter32	RO	0-4294967296	N/A
.1.3.6.1.4.1.5454.1.80.5.5.3.1	tdmPort5EventLOS	Counter32	RO	0-4294967296	N/A
.1.3.6.1.4.1.5454.1.80.5.5.3.2	tdmPort5EventLOF	Counter32	RO	0-4294967296	N/A
.1.3.6.1.4.1.5454.1.80.5.5.3.3	tdmPort5EventAIS	Counter32	RO	0-4294967296	N/A
.1.3.6.1.4.1.5454.1.80.5.5.3.4	tdmPort5EventTS16AIS	Counter32	RO	0-4294967296	N/A
.1.3.6.1.4.1.5454.1.80.5.5.3.5	tdmPort5EventRAI	Counter32	RO	0-4294967296	N/A
.1.3.6.1.4.1.5454.1.80.5.5.3.6	tdmPort5EventLCMFA	Counter32	RO	0-4294967296	N/A
.1.3.6.1.4.1.5454.1.80.5.5.3.7	tdmPort5EventLSMFA	Counter32	RO	0-4294967296	N/A
.1.3.6.1.4.1.5454.1.80.5.6.1.1	tdmPort6Status	Integer	RO	0(Off), 1(On)	0(Off)
.1.3.6.1.4.1.5454.1.80.5.6.1.2	tdmPort6CableConfig	Integer	RO	0(0-133), 1(133-266), 2(255-399), 3(399-533), 4(533-655)	0(0-133)
.1.3.6.1.4.1.5454.1.80.5.6.2.1	tdmPort6CounterCrcBlockErrors	Counter32	RO	0-4294967296	N/A
.1.3.6.1.4.1.5454.1.80.5.6.2.2	tdmPort6CounterExCrcErrors	Counter32	RO	0-4294967296	N/A
.1.3.6.1.4.1.5454.1.80.5.6.2.3	tdmPort6CounterFBAErrors	Counter32	RO	0-4294967296	N/A
.1.3.6.1.4.1.5454.1.80.5.6.2.4	tdmPort6CounterFEBErrors	Counter32	RO	0-4294967296	N/A
.1.3.6.1.4.1.5454.1.80.5.6.2.5	tdmPort6CounterLCViolations	Counter32	RO	0-4294967296	N/A
.1.3.6.1.4.1.5454.1.80.5.6.3.1	tdmPort6EventLOS	Counter32	RO	0-4294967296	N/A
.1.3.6.1.4.1.5454.1.80.5.6.3.2	tdmPort6EventLOF	Counter32	RO	0-4294967296	N/A
.1.3.6.1.4.1.5454.1.80.5.6.3.3	tdmPort6EventAIS	Counter32	RO	0-4294967296	N/A
.1.3.6.1.4.1.5454.1.80.5.6.3.4	tdmPort6EventTS16AIS	Counter32	RO	0-4294967296	N/A
.1.3.6.1.4.1.5454.1.80.5.6.3.5	tdmPort6EventRAI	Counter32	RO	0-4294967296	N/A
.1.3.6.1.4.1.5454.1.80.5.6.3.6	tdmPort6EventLCMFA	Counter32	RO	0-4294967296	N/A
.1.3.6.1.4.1.5454.1.80.5.6.3.7	tdmPort6EventLSMFA	Counter32	RO	0-4294967296	N/A

TDM Section, Cont'd

.1.3.6.1.4.1.5454.1.80.5.7.1.1	tdmPort7Status	Integer	RO	0(Off), 1(On)	0(Off)
.1.3.6.1.4.1.5454.1.80.5.7.1.2	tdmPort7CableConfig	Integer	RO	0(0-133), 1(133-266), 2(255-399), 3(399-533), 4(533-655)	0(0-133)
.1.3.6.1.4.1.5454.1.80.5.7.2.1	tdmPort7CounterCrcBlockErrors	Counter32	RO	0-4294967296	N/A
.1.3.6.1.4.1.5454.1.80.5.7.2.2	tdmPort7CounterExCrcErrors	Counter32	RO	0-4294967296	N/A
.1.3.6.1.4.1.5454.1.80.5.7.2.3	tdmPort7CounterFBAErrors	Counter32	RO	0-4294967296	N/A
.1.3.6.1.4.1.5454.1.80.5.7.2.4	tdmPort7CounterFBEErrors	Counter32	RO	0-4294967296	N/A
.1.3.6.1.4.1.5454.1.80.5.7.2.5	tdmPort7CounterLCViolations	Counter32	RO	0-4294967296	N/A
.1.3.6.1.4.1.5454.1.80.5.7.3.1	tdmPort7EventLOS	Counter32	RO	0-4294967296	N/A
.1.3.6.1.4.1.5454.1.80.5.7.3.2	tdmPort7EventLOF	Counter32	RO	0-4294967296	N/A
.1.3.6.1.4.1.5454.1.80.5.7.3.3	tdmPort7EventAIS	Counter32	RO	0-4294967296	N/A
.1.3.6.1.4.1.5454.1.80.5.7.3.4	tdmPort7EventTS16AIS	Counter32	RO	0-4294967296	N/A
.1.3.6.1.4.1.5454.1.80.5.7.3.5	tdmPort7EventRAI	Counter32	RO	0-4294967296	N/A
.1.3.6.1.4.1.5454.1.80.5.7.3.6	tdmPort7EventLCMFA	Counter32	RO	0-4294967296	N/A
.1.3.6.1.4.1.5454.1.80.5.7.3.7	tdmPort7EventLSMFA	Counter32	RO	0-4294967296	N/A
.1.3.6.1.4.1.5454.1.80.5.8.1.1	tdmPort8Status	Integer	RO	0(Off), 1(On)	0(Off)
.1.3.6.1.4.1.5454.1.80.5.8.1.2	tdmPort8CableConfig	Integer	RO	0(0-133), 1(133-266), 2(255-399), 3(399-533), 4(533-655)	0(0-133)
.1.3.6.1.4.1.5454.1.80.5.8.2.1	tdmPort8CounterCrcBlockErrors	Counter32	RO	0-4294967296	N/A
.1.3.6.1.4.1.5454.1.80.5.8.2.2	tdmPort8CounterExCrcErrors	Counter32	RO	0-4294967296	N/A
.1.3.6.1.4.1.5454.1.80.5.8.2.3	tdmPort8CounterFBAErrors	Counter32	RO	0-4294967296	N/A
.1.3.6.1.4.1.5454.1.80.5.8.2.4	tdmPort8CounterFBEErrors	Counter32	RO	0-4294967296	N/A
.1.3.6.1.4.1.5454.1.80.5.8.2.5	tdmPort8CounterLCViolations	Counter32	RO	0-4294967296	N/A
.1.3.6.1.4.1.5454.1.80.5.8.3.1	tdmPort8EventLOS	Counter32	RO	0-4294967296	N/A
.1.3.6.1.4.1.5454.1.80.5.8.3.2	tdmPort8EventLOF	Counter32	RO	0-4294967296	N/A
.1.3.6.1.4.1.5454.1.80.5.8.3.3	tdmPort8EventAIS	Counter32	RO	0-4294967296	N/A
.1.3.6.1.4.1.5454.1.80.5.8.3.4	tdmPort8EventTS16AIS	Counter32	RO	0-4294967296	N/A
.1.3.6.1.4.1.5454.1.80.5.8.3.5	tdmPort8EventRAI	Counter32	RO	0-4294967296	N/A
.1.3.6.1.4.1.5454.1.80.5.8.3.6	tdmPort8EventLCMFA	Counter32	RO	0-4294967296	N/A
.1.3.6.1.4.1.5454.1.80.5.8.3.7	tdmPort8EventLSMFA	Counter32	RO	0-4294967296	N/A

Traps

Object ID	Name	Access	Range Limit	Default Value
.1.3.6.1.4.1.5454.1.80.6.1	trapStartUp	RO	N/A	N/A
.1.3.6.1.4.1.5454.1.80.6.2.1	trapReboot	RO	N/A	N/A
.1.3.6.1.4.1.5454.1.80.6.2.2	trapIPReset	RO		
.1.3.6.1.4.1.5454.1.80.6.2.3	trapConfigReset	RO		
.1.3.6.1.4.1.5454.1.80.6.3.1	trapRPSPortUp	RO	N/A	N/A
.1.3.6.1.4.1.5454.1.80.6.3.2	trapRPSPortDown	RO	N/A	N/A
.1.3.6.1.4.1.5454.1.80.6.4.1	trapEth1StatusUpdate	RO	0(OFF), 1(ON)	N/A
.1.3.6.1.4.1.5454.1.80.6.4.2	trapEth2StatusUpdate	RO	0(OFF), 1(ON)	N/A
.1.3.6.1.4.1.5454.1.80.6.4.3	trapEth3StatusUpdate	RO	0(OFF), 1(ON)	N/A
.1.3.6.1.4.1.5454.1.80.6.4.4	trapEth4StatusUpdate	RO	0(OFF), 1(ON)	N/A
.1.3.6.1.4.1.5454.1.80.6.5.1	trapLinkLock	RO	0(NORMAL), 1(LOCKED)	N/A
.1.3.6.1.4.1.5454.1.80.6.5.2	trapACMTxProfileChange	RO	0(QPSK), 1(16Q), 2(32Q), 3(64Q), 4(128Q), 5(256Q) for non- 256Q, 0(QPSK), 1(16Q), 2(64Q), 3(256Q) for 256Q	N/A
.1.3.6.1.4.1.5454.1.80.6.5.3	trapACMRxProfileChange	RO	0(QPSK), 1(16Q), 2(32Q), 3(64Q), 4(128Q), 5(256Q) for non- 256Q, 0(QPSK), 1(16Q), 2(64Q), 3(256Q) for 256Q	N/A
.1.3.6.1.4.1.5454.1.80.6.6.1	trapIDUTempMinThreshold	RO	Current IDU Temp	N/A
.1.3.6.1.4.1.5454.1.80.6.6.2	trapIDUTempMaxThreshold	RO	Current IDU Temp	N/A
.1.3.6.1.4.1.5454.1.80.6.6.3	trapODUTempMinThreshold	RO	Current ODU Temp	N/A
.1.3.6.1.4.1.5454.1.80.6.6.4	trapODUTempMaxThreshold	RO	Current ODU Temp	N/A
.1.3.6.1.4.1.5454.1.80.6.6.5	trapMSEMinThreshold	RO	Current MSE value	N/A
.1.3.6.1.4.1.5454.1.80.6.6.6	trapMSEMaxThreshold	RO	Current MSE value	N/A
.1.3.6.1.4.1.5454.1.80.6.6.7	trapBERMinThreshold	RO	Current BER value	N/A
.1.3.6.1.4.1.5454.1.80.6.6.8	trapBERMaxThreshold	RO	Current BER value	N/A
.1.3.6.1.4.1.5454.1.80.6.6.9	trapFERMinThreshold	RO	Current FER value	N/A
.1.3.6.1.4.1.5454.1.80.6.6.10	trapFERMaxThreshold	RO	Current FER value	N/A
.1.3.6.1.4.1.5454.1.80.6.6.11	trapRSSIMinThreshold	RO	Current RSSI value	N/A
.1.3.6.1.4.1.5454.1.80.6.6.12	trapRSSIMaxThreshold	RO	Current RSSI value	N/A
.1.3.6.1.4.1.5454.1.80.6.6.13	trapInPortUtilMinThreshold	RO	Current In port utilization	N/A
.1.3.6.1.4.1.5454.1.80.6.6.14	trapInPortUtilMaxThreshold	RO	Current In port utilization	N/A
.1.3.6.1.4.1.5454.1.80.6.6.15	trapOutPortUtilMinThreshold	RO	Current Out port utilization	N/A
.1.3.6.1.4.1.5454.1.80.6.6.16	trapOutPortUtilMaxThreshold	RO	Current Out port utilization	N/A
.1.3.6.1.4.1.5454.1.80.6.7.1	trapVoltage1.25Failure	RO	1(Failed)	N/A
.1.3.6.1.4.1.5454.1.80.6.7.2	trapVoltage2.5Failure	RO	1(Failed)	N/A
.1.3.6.1.4.1.5454.1.80.6.7.3	trapVoltage3.3Failure	RO	1(Failed)	N/A
.1.3.6.1.4.1.5454.1.80.6.7.4	trapVoltage5Failure	RO	1(Failed)	N/A
.1.3.6.1.4.1.5454.1.80.6.8.1.1	trapTDM1StatusUpdate	RO	0(OFF), 1(ON)	N/A
.1.3.6.1.4.1.5454.1.80.6.8.1.2	trapTDM1LOS	RO	0(OFF), 1(ON)	N/A
.1.3.6.1.4.1.5454.1.80.6.8.2.1	trapTDM2StatusUpdate	RO	0(OFF), 1(ON)	N/A
.1.3.6.1.4.1.5454.1.80.6.8.2.2	trapTDM2LOS	RO	0(OFF), 1(ON)	N/A
.1.3.6.1.4.1.5454.1.80.6.8.3.1	trapTDM3StatusUpdate	RO	0(OFF), 1(ON)	N/A
.1.3.6.1.4.1.5454.1.80.6.8.3.2	trapTDM3LOS	RO	0(OFF), 1(ON)	N/A
.1.3.6.1.4.1.5454.1.80.6.8.4.1	trapTDM4StatusUpdate	RO	0(OFF), 1(ON)	N/A
.1.3.6.1.4.1.5454.1.80.6.8.4.2	trapTDM4LOS	RO	0(OFF), 1(ON)	N/A
.1.3.6.1.4.1.5454.1.80.6.8.5.1	trapTDM5StatusUpdate	RO	0(OFF), 1(ON)	N/A
.1.3.6.1.4.1.5454.1.80.6.8.5.2	trapTDM5LOS	RO	0(OFF), 1(ON)	N/A
.1.3.6.1.4.1.5454.1.80.6.8.6.1	trapTDM6StatusUpdate	RO	0(OFF), 1(ON)	N/A
.1.3.6.1.4.1.5454.1.80.6.8.6.2	trapTDM6LOS	RO	0(OFF), 1(ON)	N/A
.1.3.6.1.4.1.5454.1.80.6.8.7.1	trapTDM7StatusUpdate	RO	0(OFF), 1(ON)	N/A
.1.3.6.1.4.1.5454.1.80.6.8.7.2	trapTDM7LOS	RO	0(OFF), 1(ON)	N/A
.1.3.6.1.4.1.5454.1.80.6.8.8.1	trapTDM8StatusUpdate	RO	0(OFF), 1(ON)	N/A
.1.3.6.1.4.1.5454.1.80.6.8.8.2	trapTDM8LOS	RO	0(OFF), 1(ON)	N/A
.1.3.6.1.4.1.5454.1.80.6.9.1	trapManualSwitchover	RO	1(Active), 2(Standby)	N/A
.1.3.6.1.4.1.5454.1.80.6.9.2	trapHWSwitchover	RO	1(Active), 2(Standby)	N/A
.1.3.6.1.4.1.5454.1.80.6.10.1	trapRedundancyCableRemoved	RO	N/A	N/A
.1.3.6.1.4.1.5454.1.80.6.10.2	trapRedundancyCableReconnected	RO	N/A	N/A
.1.3.6.1.4.1.5454.1.80.6.11	trapLostODUCommunication	RO	N/A	N/A
.1.3.6.1.4.1.5454.1.80.6.12.1	trapUtypeActiveElected	RO	N/A	N/A
.1.3.6.1.4.1.5454.1.80.6.12.2	trapUtypeStandbyElected	RO	N/A	N/A
.1.3.6.1.4.1.5454.1.80.6.12.3	trapActiveDetected	RO	N/A	N/A
.1.3.6.1.4.1.5454.1.80.6.12.4	trapStandbyDetected	RO	N/A	N/A
.1.3.6.1.4.1.5454.1.80.6.12.5	trapActiveDown	RO	N/A	N/A
.1.3.6.1.4.1.5454.1.80.6.12.6	trapStandbyDown	RO	N/A	N/A
.1.3.6.1.4.1.5454.1.80.6.13	trapSynchronization	RO	0(Not Synchronized), 1(Synchronized)	N/A

Appendix E – Part Numbers

GigaPlus HP ODU Sub-bands/Tuning Ranges

ODU, Part Numbers	Description	TX Freq Min* (MHz)	TX Freq Max* (MHz)	Diplexer Range (MHz)	Max Chan Size (MHz)
-------------------	-------------	--------------------	--------------------	----------------------	---------------------

HP ODUs, 6 GHz

HP2-06-0160-1A	ODU, HP2 6Ghz, ANSI/ETSI TR160/170, 1A - High Band	6,540	6,600	60	56
HP2-06-0160-1B	ODU, HP2 6Ghz, ANSI/ETSI TR160/170, 1B - High Band	6,700	6,760	60	56
HP2-06-0160-2A	ODU, HP2 6Ghz, ANSI/ETSI TR160/170, 2A - High Band	6,580	6,640	60	56
HP2-06-0160-2B	ODU, HP2 6Ghz, ANSI/ETSI TR160/170, 2B - High Band	6,740	6,800	60	56
HP2-06-0160-3A	ODU, HP2 6Ghz, ANSI/ETSI TR160/170, 3A - High Band	6,620	6,680	60	56
HP2-06-0160-3B	ODU, HP2 6Ghz, ANSI/ETSI TR160/170, 3B - High Band	6,780	6,840	60	56
HP2-06-0160-4A	ODU, HP2 6Ghz, ANSI/ETSI TR160/170, 4A - High Band	6,660	6,710	50	50
HP2-06-0160-4B	ODU, HP2 6Ghz, ANSI/ETSI TR160/170, 4B - High Band	6,820	6,870	50	50

HP-06-0240-1A	ODU, HP 6Ghz, ETSI TR240, 1A - Low Band	5,925	6,025	100	56
HP-06-0240-1B	ODU, HP 6Ghz, ETSI TR240, 1B - Low Band	6,175	6,275	100	56
HP-06-0240-2A	ODU, HP 6Ghz, ETSI TR240, 2A - Low Band	6,000	6,100	100	56
HP-06-0240-2B	ODU, HP 6Ghz, ETSI TR240, 2B - Low Band	6,250	6,350	100	56
HP-06-0240-3A	ODU, HP 6Ghz, ETSI TR240, 3A - Low Band	6,075	6,175	100	56
HP-06-0240-3B	ODU, HP 6Ghz, ETSI TR240, 3B - Low Band	6,325	6,425	100	56

HP2-06-0252-1A	ODU, HP2 6Ghz, ANSI/ETSI TR252, 1A - Low Band	5,915.55	5,989.68	74	56
HP2-06-0252-1B	ODU, HP2 6Ghz, ANSI/ETSI TR252, 1B - Low Band	6,167.59	6,241.72	74	56
HP2-06-0252-2A	ODU, HP2 6Ghz, ANSI/ETSI TR252, 2A - Low Band	5,974.85	6,048.98	74	56
HP2-06-0252-2B	ODU, HP2 6Ghz, ANSI/ETSI TR252, 2B - Low Band	6,226.89	6,301.02	74	56
HP2-06-0252-3A	ODU, HP2 6Ghz, ANSI/ETSI TR252, 3A - Low Band	6,034.15	6,108.28	74	56
HP2-06-0252-3B	ODU, HP2 6Ghz, ANSI/ETSI TR252, 3B - Low Band	6,286.19	6,360.32	74	56
HP2-06-0252-4A	ODU, HP2 6Ghz, ANSI/ETSI TR252, 4A - Low Band	6,093.45	6,167.58	74	56
HP2-06-0252-4B	ODU, HP2 6Ghz, ANSI/ETSI TR252, 4B - Low Band	6,345.49	6,419.62	74	56

HP-06-0252-1A	ODU, HP 6Ghz, ANSI/ETSI TR252, 1A - Low Band	5,925	6,025	100	56
HP-06-0252-1B	ODU, HP 6Ghz, ANSI/ETSI TR252, 1B - Low Band	6,175	6,275	100	56
HP-06-0252-2A	ODU, HP 6Ghz, ANSI/ETSI TR252, 2A - Low Band	6,000	6,100	100	56
HP-06-0252-2B	ODU, HP 6Ghz, ANSI/ETSI TR252, 2B - Low Band	6,250	6,350	100	56
HP-06-0252-3A	ODU, HP 6Ghz, ANSI/ETSI TR252, 3A - Low Band	6,075	6,175	100	56
HP-06-0252-3B	ODU, HP 6Ghz, ANSI/ETSI TR252, 3B - Low Band	6,325	6,425	100	56

HP2-06-0300-1A	ODU, HP2 6Ghz, ETSI TR300, 1A - Low Band	5,850	5,946	96	56
HP2-06-0300-1B	ODU, HP2 6Ghz, ETSI TR300, 1B - Low Band	6,150	6,246	96	56
HP2-06-0300-2A	ODU, HP2 6Ghz, ETSI TR300, 2A - Low Band	5,918	6,014	96	56
HP2-06-0300-2B	ODU, HP2 6Ghz, ETSI TR300, 2B - Low Band	6,218	6,314	96	56
HP2-06-0300-3A	ODU, HP2 6Ghz, ETSI TR300, 3A - Low Band	5,986	6,082	96	56
HP2-06-0300-3B	ODU, HP2 6Ghz, ETSI TR300, 3B - Low Band	6,286	6,382	96	56
HP2-06-0300-4A	ODU, HP2 6Ghz, ETSI TR300, 4A - Low Band	6,054	6,150	96	56
HP2-06-0300-4B	ODU, HP2 6Ghz, ETSI TR300, 4B - Low Band	6,354	6,450	96	56

Outdoor Unit Part Numbers	Description	TX Freq Min* (MHz)	TX Freq Max* (MHz)	Diplexer Range (MHz)	Max Chan Size (MHz)
HP2-06-0340-7A	ODU, HP2 6Ghz, ETSI TR340/350, 7A - High Band	6,425	6,540	115	56
HP2-06-0340-7B	ODU, HP2 6Ghz, ETSI TR340/350, 7B - High Band	6,765	6,880	115	56
HP2-06-0340-8A	ODU, HP2 6Ghz, ETSI TR340/350, 8A - High Band	6,520	6,630	110	56
HP2-06-0340-8B	ODU, HP2 6Ghz, ETSI TR340/350, 8B - High Band	6,860	6,970	110	56
HP2-06-0340-9A	ODU, HP2 6Ghz, ETSI TR340/350, 9A - High Band	6,600	6,710	110	56
HP2-06-0340-9B	ODU, HP2 6Ghz, ETSI TR340/350, 9B - High Band	6,940	7,050	110	56
HP2-06-0340-10A	ODU, HP2 6Ghz, ETSI TR340/350, 10A - High Band	6,670	6,785	115	56
HP2-06-0340-10B	ODU, HP2 6Ghz, ETSI TR340/350, 10B - High Band	7,010	7,125	115	56
HP-06-0340-1A	ODU, HP 6Ghz, ETSI TR340, 1A - High Band	6,430	6,540	110	56
HP-06-0340-1B	ODU, HP 6Ghz, ETSI TR340, 1B - High Band	6,770	6,880	110	56
HP-06-0340-2A	ODU, HP 6Ghz, ETSI TR340, 2A - High Band	6,520	6,630	110	56
HP-06-0340-2B	ODU, HP 6Ghz, ETSI TR340, 2B - High Band	6,860	6,970	110	56
HP-06-0340-3A	ODU, HP 6Ghz, ETSI TR340, 3A - High Band	6,600	6,710	110	56
HP-06-0340-3B	ODU, HP 6Ghz, ETSI TR340, 3B - High Band	6,940	7,050	110	56
HP-06-0340-4A	ODU, HP 6Ghz, ETSI TR340, 4A - High Band	6,670	6,780	110	56
HP-06-0340-4B	ODU, HP 6Ghz, ETSI TR340, 4B - High Band	7,010	7,120	110	56

Outdoor Unit Part Numbers	Description	TX Freq Min* (MHz)	TX Freq Max* (MHz)	Diplexer Range (MHz)	Max Chan Size (MHz)
------------------------------	-------------	--------------------------	--------------------------	----------------------------	------------------------------

HP ODUs, 7 GHZ

HP2-07-0150-1A	ODU, HP2 7Ghz, ANSI TR150, 1A	6,875	6,945	70	56
HP2-07-0150-1B	ODU, HP2 7Ghz, ANSI TR150, 1B	7,025	7,095	70	56
HP2-07-0150-2A	ODU, HP2 7Ghz, ANSI TR150, 2A	6,905	6,975	70	56
HP2-07-0150-2B	ODU, HP2 7Ghz, ANSI TR150, 2B	7,055	7,125	70	56

HP2-07-0154-1A	ODU, HP2 7Ghz, ETSI TR154, 1A	7,428	7,484	56	56
HP2-07-0154-1B	ODU, HP2 7Ghz, ETSI TR154, 1B	7,582	7,638	56	56
HP2-07-0154-2A	ODU, HP2 7Ghz, ETSI TR154, 2A	7,470	7,526	56	56
HP2-07-0154-2B	ODU, HP2 7Ghz, ETSI TR154, 2B	7,624	7,680	56	56
HP2-07-0154-3A	ODU, HP2 7Ghz, ETSI TR154, 3A	7,512	7,568	56	56
HP2-07-0154-3B	ODU, HP2 7Ghz, ETSI TR154, 3B	7,666	7,722	56	56

HP1-07-0154-1A	ODU, HP 7Ghz, ETSI TR154, 1A	7,428	7,484	56	56
HP1-07-0154-1B	ODU, HP 7Ghz, ETSI TR154, 1B	7,582	7,638	56	56
HP1-07-0154-2A	ODU, HP 7Ghz, ETSI TR154, 2A	7,470	7,526	56	56
HP1-07-0154-2B	ODU, HP 7Ghz, ETSI TR154, 2B	7,624	7,680	56	56
HP1-07-0154-3A	ODU, HP 7Ghz, ETSI TR154, 3A	7,512	7,568	56	56
HP1-07-0154-3B	ODU, HP 7Ghz, ETSI TR154, 3B	7,666	7,722	56	56

HP2-07-0160-1A	ODU, HP2 7Ghz, ETSI TR160, 1A	7,434	7,497	63	56
HP2-07-0160-1B	ODU, HP2 7Ghz, ETSI TR160, 1B	7,594	7,657	63	56
HP2-07-0160-2A	ODU, HP2 7Ghz, ETSI TR160, 2A	7,479	7,542	63	56
HP2-07-0160-2B	ODU, HP2 7Ghz, ETSI TR160, 2B	7,639	7,702	63	56
HP2-07-0160-3A	ODU, HP2 7Ghz, ETSI TR160, 3A	7,526	7,589	63	56
HP2-07-0160-3B	ODU, HP2 7Ghz, ETSI TR160, 3B	7,686	7,749	63	56

HP1-07-0160-1A	ODU, HP 7Ghz, ETSI TR160, 1A	7,433.5	7,496.5	63	56
HP1-07-0160-1B	ODU, HP 7Ghz, ETSI TR160, 1B	7,593.5	7,656.5	63	56
HP1-07-0160-2A	ODU, HP 7Ghz, ETSI TR160, 2A	7,478.5	7,541.5	63	56
HP1-07-0160-2B	ODU, HP 7Ghz, ETSI TR160, 2B	7,638.5	7,701.5	63	56
HP1-07-0160-3A	ODU, HP 7Ghz, ETSI TR160, 3A	7,526.0	7,589.0	63	56
HP1-07-0160-3B	ODU, HP 7Ghz, ETSI TR160, 3B	7,686.0	7,749.0	63	56

HP2-07-0161-1A	ODU, HP2 7Ghz, ETSI TR161, 1A	7,114	7,177	63	56
HP2-07-0161-1B	ODU, HP2 7Ghz, ETSI TR161, 1B	7,275	7,338	63	56
HP2-07-0161-2A	ODU, HP2 7Ghz, ETSI TR161, 2A	7,149	7,212	63	56
HP2-07-0161-2B	ODU, HP2 7Ghz, ETSI TR161, 2B	7,310	7,373	63	56
HP2-07-0161-3A	ODU, HP2 7Ghz, ETSI TR161, 3A	7,184	7,247	63	56
HP2-07-0161-3B	ODU, HP2 7Ghz, ETSI TR161, 3B	7,345	7,408	63	56
HP2-07-0161-4A	ODU, HP2 7Ghz, ETSI TR161, 4A	7,219	7,282	63	56
HP2-07-0161-4B	ODU, HP2 7Ghz, ETSI TR161, 4B	7,380	7,443	63	56
HP2-07-0161-5A	ODU, HP2 7Ghz, ETSI TR161, 5A	7,239	7,302	63	56
HP2-07-0161-5B	ODU, HP2 7Ghz, ETSI TR161, 5B	7,400	7,463	63	56
HP2-07-0161-6A	ODU, HP2 7Ghz, ETSI TR161, 6A	7,274	7,337	63	56
HP2-07-0161-6B	ODU, HP2 7Ghz, ETSI TR161, 6B	7,435	7,498	63	56
HP2-07-0161-7A	ODU, HP2 7Ghz, ETSI TR161, 7A	7,309	7,372	63	56
HP2-07-0161-7B	ODU, HP2 7Ghz, ETSI TR161, 7B	7,470	7,533	63	56
HP2-07-0161-8A	ODU, HP2 7Ghz, ETSI TR161, 8A	7,344	7,407	63	56
HP2-07-0161-8B	ODU, HP2 7Ghz, ETSI TR161, 8B	7,505	7,568	63	56
HP2-07-0161-9A	ODU, HP2 7Ghz, ETSI TR161, 9A	7,414	7,477	63	56
HP2-07-0161-9B	ODU, HP2 7Ghz, ETSI TR161, 9B	7,575	7,638	63	56
HP2-07-0161-10A	ODU, HP2 7Ghz, ETSI TR161, 10A	7,449	7,512	63	56
HP2-07-0161-10B	ODU, HP2 7Ghz, ETSI TR161, 10B	7,610	7,673	63	56
HP2-07-0161-21A	ODU, HP2 7Ghz, ETSI TR161, 21A	7,484	7,547	63	56
HP2-07-0161-21B	ODU, HP2 7Ghz, ETSI TR161, 21B	7,645	7,708	63	56
HP2-07-0161-22A	ODU, HP2 7Ghz, ETSI TR161, 22A	7,519	7,582	63	56
HP2-07-0161-22B	ODU, HP2 7Ghz, ETSI TR161, 22B	7,680	7,743	63	56
HP2-07-0161-23A	ODU, HP2 7Ghz, ETSI TR161, 23A	7,539	7,602	63	56
HP2-07-0161-23B	ODU, HP2 7Ghz, ETSI TR161, 23B	7,700	7,763	63	56
HP2-07-0161-24A	ODU, HP2 7Ghz, ETSI TR161, 24A	7,574	7,637	63	56
HP2-07-0161-24B	ODU, HP2 7Ghz, ETSI TR161, 24B	7,735	7,798	63	56
HP2-07-0161-25A	ODU, HP2 7Ghz, ETSI TR161, 25A	7,609	7,672	63	56
HP2-07-0161-25B	ODU, HP2 7Ghz, ETSI TR161, 25B	7,770	7,833	63	56
HP2-07-0161-26A	ODU, HP2 7Ghz, ETSI TR161, 26A	7,644	7,707	63	56
HP2-07-0161-26B	ODU, HP2 7Ghz, ETSI TR161, 26B	7,805	7,868	63	56

Outdoor Unit Part Numbers	Description	TX Freq Min* (MHz)	TX Freq Max* (MHz)	Diplexer Range (MHz)	Max Chan Size (MHz)
HP1-07-0161-1A	ODU, HP 7Ghz, ETSI TR161, 1A	7,114	7,177	63	56
HP1-07-0161-1B	ODU, HP 7Ghz, ETSI TR161, 1B	7,275	7,338	63	56
HP1-07-0161-2A	ODU, HP 7Ghz, ETSI TR161, 2A	7,149	7,212	63	56
HP1-07-0161-2B	ODU, HP 7Ghz, ETSI TR161, 2B	7,310	7,373	63	56
HP1-07-0161-3A	ODU, HP 7Ghz, ETSI TR161, 3A	7,184	7,247	63	56
HP1-07-0161-3B	ODU, HP 7Ghz, ETSI TR161, 3B	7,345	7,408	63	56
HP1-07-0161-4A	ODU, HP 7Ghz, ETSI TR161, 4A	7,219	7,282	63	56
HP1-07-0161-4B	ODU, HP 7Ghz, ETSI TR161, 4B	7,380	7,443	63	56
HP1-07-0161-5A	ODU, HP 7Ghz, ETSI TR161, 5A	7,239	7,302	63	56
HP1-07-0161-5B	ODU, HP 7Ghz, ETSI TR161, 5B	7,400	7,463	63	56
HP1-07-0161-6A	ODU, HP 7Ghz, ETSI TR161, 6A	7,274	7,337	63	56
HP1-07-0161-6B	ODU, HP 7Ghz, ETSI TR161, 6B	7,435	7,498	63	56
HP1-07-0161-7A	ODU, HP 7Ghz, ETSI TR161, 7A	7,309	7,372	63	56
HP1-07-0161-7B	ODU, HP 7Ghz, ETSI TR161, 7B	7,470	7,533	63	56
HP1-07-0161-8A	ODU, HP 7Ghz, ETSI TR161, 8A	7,344	7,407	63	56
HP1-07-0161-8B	ODU, HP 7Ghz, ETSI TR161, 8B	7,505	7,568	63	56
HP1-07-0161-9A	ODU, HP 7Ghz, ETSI TR161, 9A	7,414	7,477	63	56
HP1-07-0161-9B	ODU, HP 7Ghz, ETSI TR161, 9B	7,575	7,638	63	56
HP1-07-0161-10A	ODU, HP 7Ghz, ETSI TR161, 10A	7,449	7,512	63	56
HP1-07-0161-10B	ODU, HP 7Ghz, ETSI TR161, 10B	7,610	7,673	63	56
HP1-07-0161-21A	ODU, HP 7Ghz, ETSI TR161, 21A	7,484	7,547	63	56
HP1-07-0161-21B	ODU, HP 7Ghz, ETSI TR161, 21B	7,645	7,708	63	56
HP1-07-0161-22A	ODU, HP 7Ghz, ETSI TR161, 22A	7,519	7,582	63	56
HP1-07-0161-22B	ODU, HP 7Ghz, ETSI TR161, 22B	7,680	7,743	63	56
HP1-07-0161-23A	ODU, HP 7Ghz, ETSI TR161, 23A	7,539	7,602	63	56
HP1-07-0161-23B	ODU, HP 7Ghz, ETSI TR161, 23B	7,700	7,763	63	56
HP1-07-0161-24A	ODU, HP 7Ghz, ETSI TR161, 24A	7,574	7,637	63	56
HP1-07-0161-24B	ODU, HP 7Ghz, ETSI TR161, 24B	7,735	7,798	63	56
HP1-07-0161-25A	ODU, HP 7Ghz, ETSI TR161, 25A	7,609	7,672	63	56
HP1-07-0161-25B	ODU, HP 7Ghz, ETSI TR161, 25B	7,770	7,833	63	56
HP1-07-0161-26A	ODU, HP 7Ghz, ETSI TR161, 26A	7,644	7,707	63	56
HP1-07-0161-26B	ODU, HP 7Ghz, ETSI TR161, 26B	7,805	7,868	63	56
HP2-07-0168-1A	ODU, HP2 7Ghz, ETSI TR168, 1A	7,443	7,499	56	56
HP2-07-0168-1B	ODU, HP2 7Ghz, ETSI TR168, 1B	7,611	7,667	56	56
HP2-07-0168-2A	ODU, HP2 7Ghz, ETSI TR168, 2A	7,485	7,541	56	56
HP2-07-0168-2B	ODU, HP2 7Ghz, ETSI TR168, 2B	7,653	7,709	56	56
HP2-07-0168-3A	ODU, HP2 7Ghz, ETSI TR168, 3A	7,527	7,583	56	56
HP2-07-0168-3B	ODU, HP2 7Ghz, ETSI TR168, 3B	7,695	7,751	56	56
HP1-07-0168-1A	ODU, HP 7Ghz, ETSI TR168, 1A	7,443	7,499	56	56
HP1-07-0168-1B	ODU, HP 7Ghz, ETSI TR168, 1B	7,611	7,667	56	56
HP1-07-0168-2A	ODU, HP 7Ghz, ETSI TR168, 2A	7,485	7,541	56	56
HP1-07-0168-2B	ODU, HP 7Ghz, ETSI TR168, 2B	7,653	7,709	56	56
HP1-07-0168-3A	ODU, HP 7Ghz, ETSI TR168, 3A	7,527	7,583	56	56
HP1-07-0168-3B	ODU, HP 7Ghz, ETSI TR168, 3B	7,695	7,751	56	56

Outdoor Unit Part Numbers	Description	TX Freq Min* (MHz)	TX Freq Max* (MHz)	Diplexer Range (MHz)	Max Chan Size (MHz)
HP2-07-0196-1A	ODU, HP2 7Ghz, ETSI TR196, 1A	7,093	7,149	56	56
HP2-07-0196-1B	ODU, HP2 7Ghz, ETSI TR196, 1B	7,289	7,345	56	56
HP2-07-0196-2A	ODU, HP2 7Ghz, ETSI TR196, 2A	7,121	7,177	56	56
HP2-07-0196-2B	ODU, HP2 7Ghz, ETSI TR196, 2B	7,317	7,373	56	56
HP2-07-0196-3A	ODU, HP2 7Ghz, ETSI TR196, 3A	7,149	7,205	56	56
HP2-07-0196-3B	ODU, HP2 7Ghz, ETSI TR196, 3B	7,345	7,401	56	56
HP2-07-0196-4A	ODU, HP2 7Ghz, ETSI TR196, 4A	7,177	7,233	56	56
HP2-07-0196-4B	ODU, HP2 7Ghz, ETSI TR196, 4B	7,373	7,429	56	56
HP2-07-0196-5A	ODU, HP2 7Ghz, ETSI TR196, 5A	7,205	7,261	56	56
HP2-07-0196-5B	ODU, HP2 7Ghz, ETSI TR196, 5B	7,401	7,457	56	56

HP1-07-0196-1A	ODU, HP 7Ghz, ETSI TR196, 1A	7,093	7,149	56	56
HP1-07-0196-1B	ODU, HP 7Ghz, ETSI TR196, 1B	7,289	7,345	56	56
HP1-07-0196-2A	ODU, HP 7Ghz, ETSI TR196, 2A	7,121	7,177	56	56
HP1-07-0196-2B	ODU, HP 7Ghz, ETSI TR196, 2B	7,317	7,373	56	56
HP1-07-0196-3A	ODU, HP 7Ghz, ETSI TR196, 3A	7,149	7,205	56	56
HP1-07-0196-3B	ODU, HP 7Ghz, ETSI TR196, 3B	7,345	7,401	56	56
HP1-07-0196-4A	ODU, HP 7Ghz, ETSI TR196, 4A	7,177	7,233	56	56
HP1-07-0196-4B	ODU, HP 7Ghz, ETSI TR196, 4B	7,373	7,429	56	56
HP1-07-0196-5A	ODU, HP 7Ghz, ETSI TR196, 5A	7,205	7,261	56	56
HP1-07-0196-5B	ODU, HP 7Ghz, ETSI TR196, 5B	7,401	7,457	56	56

HP2-07-0245-1A	ODU, HP2 7Ghz, ETSI TR245, 1A	7,400	7,484	84	56
HP2-07-0245-1B	ODU, HP2 7Ghz, ETSI TR245, 1B	7,645	7,729	84	56
HP2-07-0245-2A	ODU, HP2 7Ghz, ETSI TR245, 2A	7,484	7,568	84	56
HP2-07-0245-2B	ODU, HP2 7Ghz, ETSI TR245, 2B	7,729	7,813	84	56
HP2-07-0245-3A	ODU, HP2 7Ghz, ETSI TR245, 3A	7,568	7,652	84	56
HP2-07-0245-3B	ODU, HP2 7Ghz, ETSI TR245, 3B	7,813	7,897	84	56

HP1-07-0245-1A	ODU, HP 7Ghz, ETSI TR245, 1A	7,400	7,484	84	56
HP1-07-0245-1B	ODU, HP 7Ghz, ETSI TR245, 1B	7,645	7,729	84	56
HP1-07-0245-2A	ODU, HP 7Ghz, ETSI TR245, 2A	7,484	7,568	84	56
HP1-07-0245-2B	ODU, HP 7Ghz, ETSI TR245, 2B	7,729	7,813	84	56
HP1-07-0245-3A	ODU, HP 7Ghz, ETSI TR245, 3A	7,568	7,652	84	56
HP1-07-0245-3B	ODU, HP 7Ghz, ETSI TR245, 3B	7,813	7,897	84	56

Outdoor Unit Part Numbers	Description	TX Freq Min* (MHz)	TX Freq Max* (MHz)	Diplexer Range (MHz)	Max Chan Size (MHz)
---------------------------	-------------	--------------------	--------------------	----------------------	---------------------

HP ODUs,- 8 GHZ

HP2-08-0119-1A	ODU, HP2 8Ghz, ETSI TR119, 1A	8,279	8,307	28	28
HP2-08-0119-1B	ODU, HP2 8Ghz, ETSI TR119, 1B	8,398	8,426	28	28
HP2-08-0119-2A	ODU, HP2 8Ghz, ETSI TR119, 2A	8,293	8,321	28	28
HP2-08-0119-2B	ODU, HP2 8Ghz, ETSI TR119, 2B	8,412	8,440	28	28
HP2-08-0119-3A	ODU, HP2 8Ghz, ETSI TR119, 3A	8,307	8,335	28	28
HP2-08-0119-3B	ODU, HP2 8Ghz, ETSI TR119, 3B	8,426	8,454	28	28
HP2-08-0119-4A	ODU, HP2 8Ghz, ETSI TR119, 4A	8,321	8,349	28	28
HP2-08-0119-4B	ODU, HP2 8Ghz, ETSI TR119, 4B	8,440	8,468	28	28
HP2-08-0119-5A	ODU, HP2 8Ghz, ETSI TR119, 5A	8,335	8,363	28	28
HP2-08-0119-5B	ODU, HP2 8Ghz, ETSI TR119, 5B	8,454	8,482	28	28
HP2-08-0119-6A	ODU, HP2 8Ghz, ETSI TR119, 6A	8,349	8,377	28	28
HP2-08-0119-6B	ODU, HP2 8Ghz, ETSI TR119, 6B	8,468	8,496	28	28

HP1-08-0119-1A	ODU, HP 8Ghz, ETSI TR119, 1A	8,279	8,307	28	28
HP1-08-0119-1B	ODU, HP 8Ghz, ETSI TR119, 1B	8,398	8,426	28	28
HP1-08-0119-2A	ODU, HP 8Ghz, ETSI TR119, 2A	8,293	8,321	28	28
HP1-08-0119-2B	ODU, HP 8Ghz, ETSI TR119, 2B	8,412	8,440	28	28
HP1-08-0119-3A	ODU, HP 8Ghz, ETSI TR119, 3A	8,307	8,335	28	28
HP1-08-0119-3B	ODU, HP 8Ghz, ETSI TR119, 3B	8,426	8,454	28	28
HP1-08-0119-4A	ODU, HP 8Ghz, ETSI TR119, 4A	8,321	8,349	28	28
HP1-08-0119-4B	ODU, HP 8Ghz, ETSI TR119, 4B	8,440	8,468	28	28
HP1-08-0119-5A	ODU, HP 8Ghz, ETSI TR119, 5A	8,335	8,363	28	28
HP1-08-0119-5B	ODU, HP 8Ghz, ETSI TR119, 5B	8,454	8,482	28	28
HP1-08-0119-6A	ODU, HP 8Ghz, ETSI TR119, 6A	8,349	8,377	28	28
HP1-08-0119-6B	ODU, HP 8Ghz, ETSI TR119, 6B	8,468	8,496	28	28

HP1-08-0151-1A	ODU, HP 8Ghz, ETSI TR151, 1A	8,203	8,271	68	56
HP1-08-0151-1B	ODU, HP 8Ghz, ETSI TR151, 1B	8,355	8,423	68	56
HP1-08-0151-2A	ODU, HP 8Ghz, ETSI TR151, 2A	8,240	8,308	68	56
HP1-08-0151-2B	ODU, HP 8Ghz, ETSI TR151, 2B	8,392	8,460	68	56
HP1-08-0151-3A	ODU, HP 8Ghz, ETSI TR151, 3A	8,277	8,345	68	56
HP1-08-0151-3B	ODU, HP 8Ghz, ETSI TR151, 3B	8,429	8,497	68	56

HP2-08-0208-1A	ODU, HP2 8Ghz, ETSI TR208, 1A	8,043	8,113	70	56
HP2-08-0208-1B	ODU, HP2 8Ghz, ETSI TR208, 1B	8,251	8,321	70	56
HP2-08-0208-2A	ODU, HP2 8Ghz, ETSI TR208, 2A	8,099	8,169	70	56
HP2-08-0208-2B	ODU, HP2 8Ghz, ETSI TR208, 2B	8,307	8,377	70	56
HP2-08-0208-3A	ODU, HP2 8Ghz, ETSI TR208, 3A	8,155	8,225	70	56
HP2-08-0208-3B	ODU, HP2 8Ghz, ETSI TR208, 3B	8,363	8,433	70	56
HP2-08-0208-4A	ODU, HP2 8Ghz, ETSI TR208, 4A	8,211	8,281	70	56
HP2-08-0208-4B	ODU, HP2 8Ghz, ETSI TR208, 4B	8,419	8,489	70	56

HP1-08-0208-1A	ODU, HP 8Ghz, ETSI TR208, 1A	8,043	8,113	70	56
HP1-08-0208-1B	ODU, HP 8Ghz, ETSI TR208, 1B	8,251	8,321	70	56
HP1-08-0208-2A	ODU, HP 8Ghz, ETSI TR208, 2A	8,099	8,169	70	56
HP1-08-0208-2B	ODU, HP 8Ghz, ETSI TR208, 2B	8,307	8,377	70	56
HP1-08-0208-3A	ODU, HP 8Ghz, ETSI TR208, 3A	8,155	8,225	70	56
HP1-08-0208-3B	ODU, HP 8Ghz, ETSI TR208, 3B	8,363	8,433	70	56
HP1-08-0208-4A	ODU, HP 8Ghz, ETSI TR208, 4A	8,211	8,281	70	56
HP1-08-0208-4B	ODU, HP 8Ghz, ETSI TR208, 4B	8,419	8,489	70	56

Outdoor Unit Part Numbers	Description	TX Freq Min* (MHz)	TX Freq Max* (MHz)	Diplexer Range (MHz)	Max Chan Size (MHz)
HP2-08-0266-1A	ODU, HP2 8Ghz, ETSI TR266, 1A	7,905	8,024	119	56
HP2-08-0266-1B	ODU, HP2 8Ghz, ETSI TR266, 1B	8,171	8,290	119	56
HP2-08-0266-2A	ODU, HP2 8Ghz, ETSI TR266, 2A	8,017	8,136	119	56
HP2-08-0266-2B	ODU, HP2 8Ghz, ETSI TR266, 2B	8,283	8,402	119	56
HP1-08-0266-1A	ODU, HP 8Ghz, ETSI TR266, 1A	7,905	8,024	119	56
HP1-08-0266-1B	ODU, HP 8Ghz, ETSI TR266, 1B	8,171	8,290	119	56
HP1-08-0266-2A	ODU, HP 8Ghz, ETSI TR266, 2A	8,017	8,136	119	56
HP1-08-0266-2B	ODU, HP 8Ghz, ETSI TR266, 2B	8,283	8,402	119	56
HP2-08-0311-1A	ODU, HP2 8Ghz, ETSI TR311, 1A	7,731	7,867	136	56
HP2-08-0311-1B	ODU, HP2 8Ghz, ETSI TR311, 1B	8,042	8,178	136	56
HP2-08-0311-2A	ODU, HP2 8Ghz, ETSI TR311, 2A	7,835	7,971	136	56
HP2-08-0311-2B	ODU, HP2 8Ghz, ETSI TR311, 2B	8,146	8,282	136	56
HP1-08-0311-2A	ODU, HP 8Ghz, ETSI TR311, 2A	7,835	7,971	136	56
HP1-08-0311-2B	ODU, HP 8Ghz, ETSI TR311, 2B	8,146	8,282	136	56
HP1-08-0311-3A	ODU, HP 8Ghz, ETSI TR311, 3A	7,717	7,867	150	56
HP1-08-0311-3B	ODU, HP 8Ghz, ETSI TR311, 3B	8,028	8,178	150	56

HP ODUs,- 10 GHZ

HP2-10-0350-1A	ODU, HP2 10Ghz, ETSI TR350, 1A	10,150	10,300	150	56
HP2-10-0350-1B	ODU, HP2 10Ghz, ETSI TR350, 1B	10,500	10,650	150	56

HP ODUs,- 10.5 GHZ

HP2-10-091-1A	ODU, HP2 10.5Ghz, ANSI TR91, 1A	10,500	10,531	30	30
HP2-10-091-1B	ODU, HP2 10.5Ghz, ANSI TR91, 1B	10,591	10,622	30	30
HP2-10-091-2A	ODU, HP2 10.5Ghz, ANSI TR91, 2A	10,528	10,559	30	30
HP2-10-091-2B	ODU, HP2 10.5Ghz, ANSI TR91, 2B	10,619	10,650	30	30
HP2-10-091-3A	ODU, HP2 10.5Ghz, ANSI TR91, 3A	10,556	10,587	30	30
HP2-10-091-3B	ODU, HP2 10.5Ghz, ANSI TR91, 3B	10,647	10,678	30	30

HP ODUs, – 11 GHZ

HP2-11-0490-5A	ODU, HP2 11Ghz, ANS/ETSI TR490/500, 5A	10,700	10,890	190	56
HP2-11-0490-5B	ODU, HP2 11Ghz, ANS/ETSI TR490/500, 5B	11,200	11,390	190	56
HP2-11-0490-6A	ODU, HP2 11Ghz, ANS/ETSI TR490/500, 6A	10,855	11,045	190	56
HP2-11-0490-6B	ODU, HP2 11Ghz, ANS/ETSI TR490/500, 6B	11,355	11,545	190	56
HP2-11-0490-7A	ODU, HP2 11Ghz, ANS/ETSI TR490/500, 7A	11,010	11,200	190	56
HP2-11-0490-7B	ODU, HP2 11Ghz, ANS/ETSI TR490/500, 7B	11,510	11,700	190	56

HP1-11-0490-5A	ODU, HP 11Ghz, ANS/ETSI TR490/500, 5A	10,700	10,890	190	56
HP1-11-0490-5B	ODU, HP 11Ghz, ANS/ETSI TR490/500, 5B	11,200	11,390	190	56
HP1-11-0490-6A	ODU, HP 11Ghz, ANS/ETSI TR490/500, 6A	10,855	11,045	190	56
HP1-11-0490-6B	ODU, HP 11Ghz, ANS/ETSI TR490/500, 6B	11,355	11,545	190	56
HP1-11-0490-7A	ODU, HP 11Ghz, ANS/ETSI TR490/500, 7A	11,010	11,200	190	56
HP1-11-0490-7B	ODU, HP 11Ghz, ANS/ETSI TR490/500, 7B	11,510	11,700	190	56

HP2-11-0530-1A	ODU, HP2 11Ghz, ETSI TR530, 1A	10,675	10,855	180	56
HP2-11-0530-1B	ODU, HP2 11Ghz, ETSI TR530, 1B	11,205	11,385	180	56
HP2-11-0530-2A	ODU, HP2 11Ghz, ETSI TR530, 2A	10,795	10,975	180	56
HP2-11-0530-2B	ODU, HP2 11Ghz, ETSI TR530, 2B	11,325	11,505	180	56
HP2-11-0530-3A	ODU, HP2 11Ghz, ETSI TR530, 3A	10,915	11,135	220	56
HP2-11-0530-3B	ODU, HP2 11Ghz, ETSI TR530, 3B	11,445	11,665	220	56
HP2-11-0530-4A	ODU, HP2 11Ghz, ETSI TR530, 4A	11,035	11,215	180	56
HP2-11-0530-4B	ODU, HP2 11Ghz, ETSI TR530, 4B	11,565	11,745	180	56

HP1-11-0530-1A	ODU, HP 11Ghz, ETSI TR530, 1A	10,675	10,855	180	56
HP1-11-0530-1B	ODU, HP 11Ghz, ETSI TR530, 1B	11,205	11,385	180	56
HP1-11-0530-2A	ODU, HP 11Ghz, ETSI TR530, 2A	10,795	10,975	180	56
HP1-11-0530-2B	ODU, HP 11Ghz, ETSI TR530, 2B	11,325	11,505	180	56
HP1-11-0530-3A	ODU, HP 11Ghz, ETSI TR530, 3A	10,915	11,135	220	56
HP1-11-0530-3B	ODU, HP 11Ghz, ETSI TR530, 3B	11,445	11,665	220	56
HP1-11-0530-4A	ODU, HP 11Ghz, ETSI TR530, 4A	11,035	11,215	180	56
HP1-11-0530-4B	ODU, HP 11Ghz, ETSI TR530, 4B	11,565	11,745	180	56

Outdoor Unit Part Numbers	Description	TX Freq Min* (MHz)	TX Freq Max* (MHz)	Diplexer Range (MHz)	Max Chan Size (MHz)
---------------------------	-------------	--------------------	--------------------	----------------------	---------------------

HP ODUs, – 13 GHZ

HP2-13-0225-1A	ODU, HP2 13Ghz, ANSI TR225, 1A	12,700	12,815	115	56
HP2-13-0225-1B	ODU, HP2 13Ghz, ANSI TR225, 1B	12,925	13,040	115	56
HP2-13-0225-2A	ODU, HP2 13Ghz, ANSI TR225, 2A	12,755	12,870	115	56
HP2-13-0225-2B	ODU, HP2 13Ghz, ANSI TR225, 2B	12,980	13,095	115	56
HP2-13-0225-3A	ODU, HP2 13Ghz, ANSI TR225, 3A	12,810	12,925	115	56
HP2-13-0225-3B	ODU, HP2 13Ghz, ANSI TR225, 3B	13,035	13,150	115	56

HP2-13-0266-1A	ODU, HP2 13Ghz, ETSI TR266, 1A	12,751	12,814	63	56
HP2-13-0266-1B	ODU, HP2 13Ghz, ETSI TR266, 1B	13,017	13,080	63	56
HP2-13-0266-2A	ODU, HP2 13Ghz, ETSI TR266, 2A	12,807	12,870	63	56
HP2-13-0266-2B	ODU, HP2 13Ghz, ETSI TR266, 2B	13,073	13,136	63	56
HP2-13-0266-3A	ODU, HP2 13Ghz, ETSI TR266, 3A	12,863	12,926	63	56
HP2-13-0266-3B	ODU, HP2 13Ghz, ETSI TR266, 3B	13,129	13,192	63	56
HP2-13-0266-4A	ODU, HP2 13Ghz, ETSI TR266, 4A	12,919	12,982	63	56
HP2-13-0266-4B	ODU, HP2 13Ghz, ETSI TR266, 4B	13,185	13,248	63	56

HP1-13-0266-1A	ODU, HP 13Ghz, ETSI TR266, 1A	12,751	12,814	63	56
HP1-13-0266-1B	ODU, HP 13Ghz, ETSI TR266, 1B	13,017	13,080	63	56
HP1-13-0266-2A	ODU, HP 13Ghz, ETSI TR266, 2A	12,807	12,870	63	56
HP1-13-0266-2B	ODU, HP 13Ghz, ETSI TR266, 2B	13,073	13,136	63	56
HP1-13-0266-3A	ODU, HP 13Ghz, ETSI TR266, 3A	12,863	12,926	63	56
HP1-13-0266-3B	ODU, HP 13Ghz, ETSI TR266, 3B	13,129	13,192	63	56
HP1-13-0266-4A	ODU, HP 13Ghz, ETSI TR266, 4A	12,919	12,982	63	56
HP1-13-0266-4B	ODU, HP 13Ghz, ETSI TR266, 4B	13,185	13,248	63	56

HP ODUs, – 15 GHZ

HP2-15-0315-1A	ODU, HP2 15Ghz, ETSI TR315, 1A	14,627	14,732	105	56
HP2-15-0315-1B	ODU, HP2 15Ghz, ETSI TR315, 1B	14,942	15,047	105	56
HP2-15-0315-2A	ODU, HP2 15Ghz, ETSI TR315, 2A	14,725	14,844	119	56
HP2-15-0315-2B	ODU, HP2 15Ghz, ETSI TR315, 2B	15,040	15,159	119	56
HP2-15-0315-3A	ODU, HP2 15Ghz, ETSI TR315, 3A	14,823	14,928	105	56
HP2-15-0315-3B	ODU, HP2 15Ghz, ETSI TR315, 3B	15,138	15,243	105	56

HP1-15-0315-1A	ODU, HP 15Ghz, ETSI TR315, 1A	14,627	14,746	119	56
HP1-15-0315-1B	ODU, HP 15Ghz, ETSI TR315, 1B	14,942	15,061	119	56
HP1-15-0315-2A	ODU, HP 15Ghz, ETSI TR315, 2A	14,725	14,844	119	56
HP1-15-0315-2B	ODU, HP 15Ghz, ETSI TR315, 2B	15,040	15,159	119	56
HP1-15-0315-3A	ODU, HP 15Ghz, ETSI TR315, 3A	14,823	14,942	119	56
HP1-15-0315-3B	ODU, HP 15Ghz, ETSI TR315, 3B	15,138	15,257	119	56

HP2-15-0420-4A	ODU, HP2 15Ghz, ETSI TR420, 4A	14,501	14,613	112	56
HP2-15-0420-4B	ODU, HP2 15Ghz, ETSI TR420, 4B	14,921	15,033	112	56
HP2-15-0420-5A	ODU, HP2 15Ghz, ETSI TR420, 5A	14,606	14,725	119	56
HP2-15-0420-5B	ODU, HP2 15Ghz, ETSI TR420, 5B	15,026	15,145	119	56
HP2-15-0420-6A	ODU, HP2 15Ghz, ETSI TR420, 6A	14,718	14,837	119	56
HP2-15-0420-6B	ODU, HP2 15Ghz, ETSI TR420, 6B	15,138	15,257	119	56
HP2-15-0420-7A	ODU, HP2 15Ghz, ETSI TR420, 7A	14,816	14,928	112	56
HP2-15-0420-7B	ODU, HP2 15Ghz, ETSI TR420, 7B	15,236	15,348	112	56

HP1-15-0420-4A	ODU, HP 15Ghz, ETSI TR420, 4A	14,501	14,613	112	56
HP1-15-0420-4B	ODU, HP 15Ghz, ETSI TR420, 4B	14,921	15,033	112	56
HP1-15-0420-5A	ODU, HP 15Ghz, ETSI TR420, 5A	14,606	14,725	119	56
HP1-15-0420-5B	ODU, HP 15Ghz, ETSI TR420, 5B	15,026	15,145	119	56
HP1-15-0420-6A	ODU, HP 15Ghz, ETSI TR420, 6A	14,718	14,837	119	56
HP1-15-0420-6B	ODU, HP 15Ghz, ETSI TR420, 6B	15,138	15,257	119	56
HP1-15-0420-7A	ODU, HP 15Ghz, ETSI TR420, 7A	14,816	14,928	112	56
HP1-15-0420-7B	ODU, HP 15Ghz, ETSI TR420, 7B	15,236	15,348	112	56

Outdoor Unit Part Numbers	Description	TX Freq Min* (MHz)	TX Freq Max* (MHz)	Diplexer Range (MHz)	Max Chan Size (MHz)
HP2-15-0490-4A	ODU, HP2 15Ghz, ETSI TR490, 4A	14,403	14,522	119	56
HP2-15-0490-4B	ODU, HP2 15Ghz, ETSI TR490, 4B	14,893	15,012	119	56
HP2-15-0490-5A	ODU, HP2 15Ghz, ETSI TR490, 5A	14,515	14,634	119	56
HP2-15-0490-5B	ODU, HP2 15Ghz, ETSI TR490, 5B	15,005	15,124	119	56
HP2-15-0490-6A	ODU, HP2 15Ghz, ETSI TR490, 6A	14,627	14,746	119	56
HP2-15-0490-6B	ODU, HP2 15Ghz, ETSI TR490, 6B	15,117	15,236	119	56
HP2-15-0490-7A	ODU, HP2 15Ghz, ETSI TR490, 7A	14,739	14,858	119	56
HP2-15-0490-7B	ODU, HP2 15Ghz, ETSI TR490, 7B	15,229	15,348	119	56

HP1-15-0490-4A	ODU, HP 15Ghz, ETSI TR490, 4A	14,403	14,522	119	56
HP1-15-0490-4B	ODU, HP 15Ghz, ETSI TR490, 4B	14,893	15,012	119	56
HP1-15-0490-5A	ODU, HP 15Ghz, ETSI TR490, 5A	14,515	14,634	119	56
HP1-15-0490-5B	ODU, HP 15Ghz, ETSI TR490, 5B	15,005	15,124	119	56
HP1-15-0490-6A	ODU, HP 15Ghz, ETSI TR490, 6A	14,627	14,746	119	56
HP1-15-0490-6B	ODU, HP 15Ghz, ETSI TR490, 6B	15,117	15,236	119	56
HP1-15-0490-7A	ODU, HP 15Ghz, ETSI TR490, 7A	14,739	14,858	119	56
HP1-15-0490-7B	ODU, HP 15Ghz, ETSI TR490, 7B	15,229	15,348	119	56

HP2-15-0475-1A	ODU, HP2 15Ghz, ETSI TR475, 1A	14,500	14,668	168	56
HP2-15-0475-1B	ODU, HP2 15Ghz, ETSI TR475, 1B	14,975	15,143	168	56
HP2-15-0475-2A	ODU, HP2 15Ghz, ETSI TR475, 2A	14,660	14,828	168	56
HP2-15-0475-2B	ODU, HP2 15Ghz, ETSI TR475, 2B	15,135	15,303	168	56
HP2-15-0475-3A	ODU, HP2 15Ghz, ETSI TR475, 3A	14,715	14,883	168	56
HP2-15-0475-3B	ODU, HP2 15Ghz, ETSI TR475, 3B	15,190	15,358	168	56

HP1-15-0475-1A	ODU, HP 15Ghz, ETSI TR475, 1A	14,500	14,668	168	56
HP1-15-0475-1B	ODU, HP 15Ghz, ETSI TR475, 1B	14,975	15,143	168	56
HP1-15-0475-2A	ODU, HP 15Ghz, ETSI TR475, 2A	14,660	14,828	168	56
HP1-15-0475-2B	ODU, HP 15Ghz, ETSI TR475, 2B	15,135	15,303	168	56
HP1-15-0475-3A	ODU, HP 15Ghz, ETSI TR475, 3A	14,783	14,883	100	56
HP1-15-0475-3B	ODU, HP 15Ghz, ETSI TR475, 3B	15,258	15,358	100	56

HP2-15-0640-1A	ODU, HP2 15Ghz, ETSI TR640, 1A	14,500	14,610	110	56
HP2-15-0640-1B	ODU, HP2 15Ghz, ETSI TR640, 1B	15,140	15,250	110	56
HP2-15-0640-2A	ODU, HP2 15Ghz, ETSI TR640, 2A	14,605	14,715	110	56
HP2-15-0640-2B	ODU, HP2 15Ghz, ETSI TR640, 2B	15,245	15,355	110	56

HP1-15-0640-1A	ODU, HP 15Ghz, ETSI TR640, 1A	14,500	14,610	110	56
HP1-15-0640-1B	ODU, HP 15Ghz, ETSI TR640, 1B	15,140	15,250	110	56
HP1-15-0640-2A	ODU, HP 15Ghz, ETSI TR640, 2A	14,605	14,715	110	56
HP1-15-0640-2B	ODU, HP 15Ghz, ETSI TR640, 2B	15,245	15,355	110	56

HP2-15-0644-1A	ODU, HP2 15Ghz, ETSI TR644, 1A	14,400	14,512	112	56
HP2-15-0644-1B	ODU, HP2 15Ghz, ETSI TR644, 1B	15,044	15,156	112	56
HP2-15-0644-2A	ODU, HP2 15Ghz, ETSI TR644, 2A	14,498	14,610	112	56
HP2-15-0644-2B	ODU, HP2 15Ghz, ETSI TR644, 2B	15,142	15,254	112	56
HP2-15-0644-3A	ODU, HP2 15Ghz, ETSI TR644, 3A	14,596	14,708	112	56
HP2-15-0644-3B	ODU, HP2 15Ghz, ETSI TR644, 3B	15,240	15,352	112	56

HP1-15-0644-1A	ODU, HP 15Ghz, ETSI TR644, 1A	14,400	14,512	112	56
HP1-15-0644-1B	ODU, HP 15Ghz, ETSI TR644, 1B	15,044	15,156	112	56
HP1-15-0644-2A	ODU, HP 15Ghz, ETSI TR644, 2A	14,498	14,610	112	56
HP1-15-0644-2B	ODU, HP 15Ghz, ETSI TR644, 2B	15,142	15,254	112	56
HP1-15-0644-3A	ODU, HP 15Ghz, ETSI TR644, 3A	14,596	14,708	112	56
HP1-15-0644-3B	ODU, HP 15Ghz, ETSI TR644, 3B	15,240	15,352	112	56

Outdoor Unit Part Numbers	Description	TX Freq Min* (MHz)	TX Freq Max* (MHz)	Diplexer Range (MHz)	Max Chan Size (MHz)
HP1-15-0728-1A	ODU, HP 15Ghz, ETSI TR728, 1A	14,500	14,615	115	56
HP1-15-0728-1B	ODU, HP 15Ghz, ETSI TR728, 1B	15,228	15,343	115	56
HP1-15-0728-2A	ODU, HP 15Ghz, ETSI TR728, 2A	14,500	14,625	125	56
HP1-15-0728-2B	ODU, HP 15Ghz, ETSI TR728, 2B	15,228	15,353	125	56
HP2-15-0728-1A	ODU, HP2 15Ghz, ETSI TR728, 1A	14,500	14,615	115	56
HP2-15-0728-1B	ODU, HP2 15Ghz, ETSI TR728, 1B	15,228	15,343	115	56

HP ODUs, – 18 GHZ

HP2-18-1010-1A	ODU, HP2 18Ghz, ETSI TR1010/1008, 1A	17,685	17,985	300	56
HP2-18-1010-1B	ODU, HP2 18Ghz, ETSI TR1010/1008, 1B	18,695	18,995	300	56
HP2-18-1010-2A	ODU, HP2 18Ghz, ETSI TR1010/1008, 2A	17,930	18,230	300	56
HP2-18-1010-2B	ODU, HP2 18Ghz, ETSI TR1010/1008, 2B	18,940	19,240	300	56
HP2-18-1010-3A	ODU, HP2 18Ghz, ETSI TR1010/1008, 3A	18,180	18,480	300	56
HP2-18-1010-3B	ODU, HP2 18Ghz, ETSI TR1010/1008, 3B	19,190	19,490	300	56
HP2-18-1010-4A	ODU, HP2 18Ghz, ETSI TR1010/1008, 4A	18,400	18,700	300	56
HP2-18-1010-4B	ODU, HP2 18Ghz, ETSI TR1010/1008, 4B	19,410	19,710	300	56
HP1-18-1010-1A	ODU, HP 18Ghz, ETSI TR1010/1008, 1A	17,685	17,985	300	56
HP1-18-1010-1B	ODU, HP 18Ghz, ETSI TR1010/1008, 1B	18,695	18,995	300	56
HP1-18-1010-2A	ODU, HP 18Ghz, ETSI TR1010/1008, 2A	17,930	18,230	300	56
HP1-18-1010-2B	ODU, HP 18Ghz, ETSI TR1010/1008, 2B	18,940	19,240	300	56
HP1-18-1010-3A	ODU, HP 18Ghz, ETSI TR1010/1008, 3A	18,180	18,480	300	56
HP1-18-1010-3B	ODU, HP 18Ghz, ETSI TR1010/1008, 3B	19,190	19,490	300	56
HP1-18-1010-4A	ODU, HP 18Ghz, ETSI TR1010/1008, 4A	18,400	18,700	300	56
HP1-18-1010-4B	ODU, HP 18Ghz, ETSI TR1010/1008, 4B	19,410	19,710	300	56
HP1-18-1092-1A	ODU, HP 18Ghz, ETSI TR1092, 1A	17,700	18,060	360	56
HP1-18-1092-1B	ODU, HP 18Ghz, ETSI TR1092, 1B	18,805	19,165	360	56
HP1-18-1092-2A	ODU, HP 18Ghz, ETSI TR1092, 2A	17,975	18,335	360	56
HP1-18-1092-2B	ODU, HP 18Ghz, ETSI TR1092, 2B	19,080	19,440	360	56
HP1-18-1092-3A	ODU, HP 18Ghz, ETSI TR1092, 3A	18,235	18,595	360	56
HP1-18-1092-3B	ODU, HP 18Ghz, ETSI TR1092, 3B	19,340	19,700	360	56
HP2-18-1560-3A	ODU, HP2 18Ghz, ANSI TR1560, 3A	17,700	18,140	440	56
HP2-18-1560-3B	ODU, HP2 18Ghz, ANSI TR1560, 3B	19,260	19,700	440	56
HP1-18-1560-3A	ODU, HP 18Ghz, ANSI TR1560, 3A	17,700	18,140	440	56
HP1-18-1560-3B	ODU, HP 18Ghz, ANSI TR1560, 3B	19,260	19,700	440	56

Outdoor Unit Part Numbers	Description	TX Freq Min* (MHz)	TX Freq Max* (MHz)	Diplexer Range (MHz)	Max Chan Size (MHz)
------------------------------	-------------	--------------------------	--------------------------	----------------------------	------------------------------

HP ODUs, – 23 GHZ

HP2-23-1008-1A	ODU, HP2 23Ghz, ETSI TR1008, 1A	22,000	22,314	314	56
HP2-23-1008-1B	ODU, HP2 23Ghz, ETSI TR1008, 1B	23,008	23,322	314	56
HP2-23-1008-2A	ODU, HP2 23Ghz, ETSI TR1008, 2A	22,286	22,600	314	56
HP2-23-1008-2B	ODU, HP2 23Ghz, ETSI TR1008, 2B	23,294	23,608	314	56

HP1-23-1008-1A	ODU, HP 23Ghz, ETSI TR1008, 1A	21,994	22,330	336	56
HP1-23-1008-1B	ODU, HP 23Ghz, ETSI TR1008, 1B	23,002	23,338	336	56
HP1-23-1008-2A	ODU, HP 23Ghz, ETSI TR1008, 2A	22,274	22,610	336	56
HP1-23-1008-2B	ODU, HP 23Ghz, ETSI TR1008, 2B	23,282	23,618	336	56

HP2-23-1200-5A	ODU, HP2 23Ghz, ANSI TR1200, 5A	21,200	21,600	400	56
HP2-23-1200-5B	ODU, HP2 23Ghz, ANSI TR1200, 5B	22,400	22,800	400	56
HP2-23-1200-6A	ODU, HP2 23Ghz, ANSI TR1200, 6A	21,600	22,000	400	56
HP2-23-1200-6B	ODU, HP2 23Ghz, ANSI TR1200, 6B	22,800	23,200	400	56
HP2-23-1200-7A	ODU, HP2 23Ghz, ANSI TR1200, 7A	22,000	22,400	400	56
HP2-23-1200-7B	ODU, HP2 23Ghz, ANSI TR1200, 7B	23,200	23,600	400	56

HP1-23-1200-5A	ODU, HP 23Ghz, ANSI TR1200, 5A	21,200	21,600	400	56
HP1-23-1200-5B	ODU, HP 23Ghz, ANSI TR1200, 5B	22,400	22,800	400	56
HP1-23-1200-6A	ODU, HP 23Ghz, ANSI TR1200, 6A	21,600	22,000	400	56
HP1-23-1200-6B	ODU, HP 23Ghz, ANSI TR1200, 6B	22,800	23,200	400	56
HP1-23-1200-7A	ODU, HP 23Ghz, ANSI TR1200, 7A	22,000	22,400	400	56
HP1-23-1200-7B	ODU, HP 23Ghz, ANSI TR1200, 7B	23,200	23,600	400	56

HP2-23-1232-1A	ODU, HP2 23Ghz, ETSI TR1232, 1A	21,200	21,500	300	56
HP2-23-1232-1B	ODU, HP2 23Ghz, ETSI TR1232, 1B	22,432	22,732	300	56
HP2-23-1232-2A	ODU, HP2 23Ghz, ETSI TR1232, 2A	21,472	21,786	314	56
HP2-23-1232-2B	ODU, HP2 23Ghz, ETSI TR1232, 2B	22,704	23,018	314	56
HP2-23-1232-3A	ODU, HP2 23Ghz, ETSI TR1232, 3A	21,779	22,093	314	56
HP2-23-1232-3B	ODU, HP2 23Ghz, ETSI TR1232, 3B	23,011	23,325	314	56
HP2-23-1232-4A	ODU, HP2 23Ghz, ETSI TR1232, 4A	22,086	22,386	300	56
HP2-23-1232-4B	ODU, HP2 23Ghz, ETSI TR1232, 4B	23,318	23,618	300	56

HP1-23-1232-1A	ODU, HP 23Ghz, ETSI TR1232, 1A	21,200	21,500	300	56
HP1-23-1232-1B	ODU, HP 23Ghz, ETSI TR1232, 1B	22,432	22,732	300	56
HP1-23-1232-2A	ODU, HP 23Ghz, ETSI TR1232, 2A	21,472	21,786	314	56
HP1-23-1232-2B	ODU, HP 23Ghz, ETSI TR1232, 2B	22,704	23,018	314	56
HP1-23-1232-3A	ODU, HP 23Ghz, ETSI TR1232, 3A	21,779	22,093	314	56
HP1-23-1232-3B	ODU, HP 23Ghz, ETSI TR1232, 3B	23,011	23,325	314	56
HP1-23-1232-4A	ODU, HP 23Ghz, ETSI TR1232, 4A	22,086	22,386	300	56
HP1-23-1232-4B	ODU, HP 23Ghz, ETSI TR1232, 4B	23,318	23,618	300	56

Outdoor Unit Part Numbers	Description	TX Freq Min* (MHz)	TX Freq Max* (MHz)	Diplexer Range (MHz)	Max Chan Size (MHz)
------------------------------	-------------	--------------------------	--------------------------	----------------------------	------------------------------

HP ODUs, – 26 GHZ

HP2-26-0800-1A	ODU, HP2 26Ghz, ETSI TR800, 1A	24,250	24,450	200	56
HP2-26-0800-1B	ODU, HP2 26Ghz, ETSI TR800, 1B	25,050	25,250	200	56

HP-26-0800-1A	ODU, HP 26Ghz, ETSI TR800, 1A	24,250	24,450	200	56
HP-26-0800-1B	ODU, HP 26Ghz, ETSI TR800, 1B	25,050	25,250	200	56

HP2-26-1008-1A	ODU, HP2 26Ghz, ETSI TR1008, 1A	24,549	24,871	322	56
HP2-26-1008-1B	ODU, HP2 26Ghz, ETSI TR1008, 1B	25,557	25,879	322	56
HP2-26-1008-2A	ODU, HP2 26Ghz, ETSI TR1008, 2A	24,843	25,151	308	56
HP2-26-1008-2B	ODU, HP2 26Ghz, ETSI TR1008, 2B	25,851	26,159	308	56
HP2-26-1008-3A	ODU, HP2 26Ghz, ETSI TR1008, 3A	25,123	25,445	322	56
HP2-26-1008-3B	ODU, HP2 26Ghz, ETSI TR1008, 3B	26,131	26,453	322	56

HP-26-1008-1A	ODU, HP 26Ghz, ETSI TR1008, 1A	24,549	24,885	336	56
HP-26-1008-1B	ODU, HP 26Ghz, ETSI TR1008, 1B	25,557	25,893	336	56
HP-26-1008-2A	ODU, HP 26Ghz, ETSI TR1008, 2A	24,829	25,165	336	56
HP-26-1008-2B	ODU, HP 26Ghz, ETSI TR1008, 2B	25,837	26,173	336	56
HP-26-1008-3A	ODU, HP 26Ghz, ETSI TR1008, 3A	25,109	25,445	336	56
HP-26-1008-3B	ODU, HP 26Ghz, ETSI TR1008, 3B	26,117	26,453	336	56

HP ODUs, – 28 GHZ

HP-28-1008-1A	ODU, HP 28Ghz, ETSI TR1008, 1A	27,520	28,025	505	56
HP-28-1008-1B	ODU, HP 28Ghz, ETSI TR1008, 1B	28,528	29,033	505	56
HP-28-1008-2A	ODU, HP 28Ghz, ETSI TR1008, 2A	27,968	28,473	505	56
HP-28-1008-2B	ODU, HP 28Ghz, ETSI TR1008, 2B	28,976	29,481	505	56

HP2-28-1008-1A	ODU, HP 28Ghz, ETSI TR1008, 1A	27,520	28,025	1008	56
HP2-28-1008-1B	ODU, HP 28Ghz, ETSI TR1008, 1B	28,528	29,033	1008	56
HP2-28-1008-2A	ODU, HP 28Ghz, ETSI TR1008, 2A	27,968	28,473	1008	56
HP2-28-1008-2B	ODU, HP 28Ghz, ETSI TR1008, 2B	28,976	29,481	1008	56

HP2-28-450-1A	ODU, HP 28Ghz, ANSI TR450 1A	27,500	27,680	450	56
HP2-28-450-1B	ODU, HP 28Ghz, ANSI TR450 1B	27,950	28,130	450	56
HP2-28-450-2A	ODU, HP 28Ghz, ANSI TR450 2A	27,610	27,790	450	56
HP2-28-450-2B	ODU, HP 28Ghz, ANSI TR450 2B	28,060	28,240	450	56
HP2-28-450-3A	ODU, HP 28Ghz, ANSI TR450 3A	27,720	27,900	450	56
HP2-28-450-3B	ODU, HP 28Ghz, ANSI TR450 3B	28,170	28,350	450	56

HP ODUs, – 32 GHZ

HP-32-0812-1A	ODU, HP 32Ghz, ETSI TR812, 1A	31,815	32,207	392	56
HP-32-0812-1B	ODU, HP 32Ghz, ETSI TR812, 1B	32,627	33,019	392	56
HP-32-0812-2A	ODU, HP 32Ghz, ETSI TR812, 2A	32,179	32,571	392	56
HP-32-0812-2B	ODU, HP 32Ghz, ETSI TR812, 2B	32,991	33,383	392	56

HP ODUs – 38 GHZ

HP1-38-0700-1A	ODU, HP 38Ghz, ANSI/ETSI TR700, 1A	38,595	38,805	210	56
HP1-38-0700-1B	ODU, HP 38Ghz, ANSI/ETSI TR700, 1B	39,295	39,505	210	56
HP1-38-0700-2A	ODU, HP 38Ghz, ANSI/ETSI TR700, 2A	38,795	39,005	210	56
HP1-38-0700-2B	ODU, HP 38Ghz, ANSI/ETSI TR700, 2B	39,495	39,705	210	56
HP1-38-0700-3A	ODU, HP 38Ghz, ANSI/ETSI TR700, 3A	38,995	39,205	210	56
HP1-38-0700-3B	ODU, HP 38Ghz, ANSI/ETSI TR700, 3B	39,695	39,905	210	56
HP1-38-0700-4A	ODU, HP 38Ghz, ANSI/ETSI TR700, 4A	39,195	39,405	210	56
HP1-38-0700-4B	ODU, HP 38Ghz, ANSI/ETSI TR700, 4B	39,895	40,105	210	56

HP2-38-1260-1A	ODU, HP2 38Ghz ETSI TR1260, 1A	37,044	37,632	588	56
HP2-38-1260-1B	ODU, HP2 38Ghz ETSI TR1260, 1B	38,304	38,892	588	56
HP2-38-1260-2A	ODU, HP2 38Ghz ETSI TR1260, 2A	37,604	38,192	588	56
HP2-38-1260-2B	ODU, HP2 38Ghz ETSI TR1260, 2B	38,864	39,452	588	56

HP1-38-1260-1A	ODU, HP 38Ghz, ANSI/ETSI TR1260, 1A	37,044	37,632	588	56
HP1-38-1260-1B	ODU, HP 38Ghz, ANSI/ETSI TR1260, 1B	38,304	38,892	588	56
HP1-38-1260-2A	ODU, HP 38Ghz, ANSI/ETSI TR1260, 2A	37,604	38,192	588	56
HP1-38-1260-2B	ODU, HP 38Ghz, ANSI/ETSI TR1260, 2B	38,864	39,452	588	56

* Frequencies shown are NOT center frequencies, but rather the edge of the transmit band.
Center frequency limits are 1/2 the channel bandwidth away from these numbers.

Accessories

TRANGO PtP MICROWAVE BAND SPECIFIC ACCESSORIES							
Model	Antenna	3/3 dB Dir Mnt Comb	1.9/6 dB Dir Mnt Comb	Dir Mnt Ortho Comb	Remote Mount	Rem Mnt 3/3 dB Comb	Rem Mnt 1.9/6 dB Comb

HP ODUs - 6 GHZ

HP-06-0240-xx	AD6GL-xx-R2, -R3	SMC-06-3-HP	SMC-06-6-HP	OMC-06-HP	HP-MNT-06-WR137	SMC-06-3-HP-R	SMC-06-6-HP-R
HP-06-0252-xx	AD6GL-xx-R2, -R3	SMC-06-3-HP	SMC-06-6-HP	OMC-06-HP	HP-MNT-06-WR137	SMC-06-3-HP-R	SMC-06-6-HP-R
HP-06-0340-xx	AD6GU-xx-R2, -R3	SMC-06-3-HP	SMC-06-6-HP	OMC-06-HP	HP-MNT-06-WR137	SMC-06-3-HP-R	SMC-06-6-HP-R
HP2-06-0160-xx	AD6GU-xx-R4, -R3	SMC-06-3-HP2	SMC-06-6-HP2	OMC-06-HP2	HP2-MNT-6-WR137	SMC-06-3-HP-R	SMC-06-6-HP-R
HP2-06-0170-xx	AD6GU-xx-R4, -R3	SMC-06-3-HP2	SMC-06-6-HP2	OMC-06-HP2	HP2-MNT-6-WR137	SMC-06-3-HP-R	SMC-06-6-HP-R
HP2-06-0252-xx	AD6GL-xx-R4, -R3	SMC-06-3-HP2	SMC-06-6-HP2	OMC-06-HP2	HP2-MNT-6-WR137	SMC-06-3-HP-R	SMC-06-6-HP-R
HP2-06-0300-xx	AD6GL-xx-R4, -R3	SMC-06-3-HP2	SMC-06-6-HP2	OMC-06-HP2	HP2-MNT-6-WR137	SMC-06-3-HP-R	SMC-06-6-HP-R
HP2-06-0340-xx	AD6GU-xx-R4, -R3	SMC-06-3-HP2	SMC-06-6-HP2	OMC-06-HP2	HP2-MNT-6-WR137	SMC-06-3-HP-R	SMC-06-6-HP-R
HP2-06-0350-xx	AD6GU-xx-R4, -R3	SMC-06-3-HP2	SMC-06-6-HP2	OMC-06-HP2	HP2-MNT-6-WR137	SMC-06-3-HP-R	SMC-06-6-HP-R

Note: All -R3 Antennas require a Remote Mount for the ODU and Waveguide

HP ODUs - 7 GHZ

HP-07-xxxx-xx	AD7G-xx-S2	SMC-78-3-HP	SMC-78-6-HP	OMC-07-HP	HP-MNT-78-WR112	SMC-78-3-HP-R	SMC-78-6-HP-R
HP2-07-xxxx-xx	AD7G-xx-S2	SMC-78-3-HP	SMC-78-6-HP	OMC-07-HP	HP-MNT-78-WR112	SMC-78-3-HP-R	SMC-78-6-HP-R

HP ODUs - 8 GHZ

HP-08-xxxx-xx	AD8G-xx-R2	SMC-78-3-HP	SMC-78-6-HP	OMC-07-HP	HP-MNT-78-WR112	SMC-78-3-HP-R	SMC-78-6-HP-R
HP2-08-xxxx-xx	AD8G-xx-R2	SMC-78-3-HP	SMC-78-6-HP	OMC-07-HP	HP-MNT-78-WR112	SMC-78-3-HP-R	SMC-78-6-HP-R

HP ODUs - 10 GHZ

HP2-10-xxxx-xx	AD10G-xx-S2	NA	NA	NA	NA	NA	NA
----------------	-------------	----	----	----	----	----	----

HP ODUs - 11 GHZ

HP-11-xxxx-xx	AD11G-xx-S2, -R2	SMC-11-3-HP	SMC-11-6-HP	OMC-11-HP	HP-MNT-11-WR75	SMC-11-3-HP-R	SMC-11-6-HP-R
HP2-11-xxxx-xx	AD11G-xx-S2, -R2	SMC-11-3-HP	SMC-11-6-HP	OMC-11-HP	HP-MNT-11-WR75	SMC-11-3-HP-R	SMC-11-6-HP-R

HP ODUs - 13 GHZ

HP-13-xxxx-xx	AD13G-xx-S2, -R2	SMC-13-3-HP	SMC-13-6-HP	OMC-13-HP	HP-MNT-13-WR75	SMC-13-3-HP-R	SMC-13-6-HP-R
HP2-13-xxxx-xx	AD13G-xx-S2, -R2	SMC-13-3-HP	SMC-13-6-HP	OMC-13-HP	HP-MNT-13-WR75	SMC-13-3-HP-R	SMC-13-6-HP-R

HP ODUs - 15GHZ

HP-15-xxxx-xx	AD15G-xx-S2	SMC-15-3-HP	SMC-15-6-HP	OMC-15-HP	HP-MNT-15-WR62	SMC-15-3-HP-R	SMC-15-6-HP-R
HP2-15-xxxx-xx	AD15G-xx-S2	SMC-15-3-HP	SMC-15-6-HP	OMC-15-HP	HP-MNT-15-WR62	SMC-15-3-HP-R	SMC-15-6-HP-R

HP ODUs - 18 GHZ

HP-18-xxxx-xx	AD18G-xx-S2, R2	SMC-18-3-HP	SMC-18-6-HP	OMC-18-HP	HP-MNT-18-WR42	SMC-18-3-HP-R	SMC-18-6-HP-R
HP2-18-xxxx-xx	AD18G-xx-S2, R2	SMC-18-3-HP	SMC-18-6-HP	OMC-18-HP	HP-MNT-18-WR42	SMC-18-3-HP-R	SMC-18-6-HP-R

HP ODUs - 23 GHZ

HP-23-xxxx-xx	AD23G-xx-S2, -R2	SMC-23-3-HP	SMC-23-6-HP	OMC-23-HP	HP-MNT-23-WR42	SMC-23-6-HP-R	SMC-26-3-HP-R
HP2-23-xxxx-xx	AD23G-xx-S2, -R2	SMC-23-3-HP	SMC-23-6-HP	OMC-23-HP	HP-MNT-23-WR42	SMC-23-6-HP-R	SMC-26-3-HP-R

HP ODUs - 26 GHZ

HP-26-xxxx-xx	AD26G-xx-S2	SMC-26-3-HP	SMC-26-6-HP	NA	HP-MNT-26-WR42	SMC-26-3-HP-R	SMC-26-6-HP-R
HP2-26-xxxx-xx	AD26G-xx-S2	SMC-26-3-HP	SMC-26-6-HP	NA	HP-MNT-26-WR42	SMC-26-3-HP-R	SMC-26-6-HP-R

HP ODUs - 26 GHZ

HP-28-xxxx-xx	AD28G-xx-R2	SMC-28-3-HP	SMC-28-6-HP	NA	HP-MNT-28-WR28	SMC-28-3-HP-R	SMC-28-6-HP-R
---------------	-------------	-------------	-------------	----	----------------	---------------	---------------

HP ODUs - 32 GHZ

HP-32-xxxx-xx	AD32G-xx-R2	SMC-32-3-HP	SMC-32-6-HP	NA	HP-MNT-32-WR28	SMC-32-3-HP-R	SMC-32-6-HP-R
---------------	-------------	-------------	-------------	----	----------------	---------------	---------------

HP ODUs - 38 GHZ

HP-38-xxxx-xx	AD38G-xx-R2	SMC-38-3-HP	SMC-38-6-HP	OMC-38-HP	HP-MNT-38-WR28	SMC-38-3-HP-R	SMC-38-6-HP-R
HP-38-xxxx-xx	AD38G-xx-R2	SMC-38-3-HP	SMC-38-6-HP	OMC-38-HP	HP-MNT-38-WR28	SMC-38-3-HP-R	SMC-38-6-HP-R
HP2-38-xxxx-xx	AD38G-xx-R2	SMC-38-3-HP	SMC-38-6-HP	OMC-38-HP	HP-MNT-38-WR28	SMC-38-3-HP-R	SMC-38-6-HP-R

Appendix F – Link Install and Commissioning Logs

Standardized forms are provided here for use during the installation and configuration phase and to serve as a record of the link performance at the time of installation. It is highly recommended that the operator use the *status save* feature in the radio to save the state of the link upon commissioning.

Site Information

Customer:	
Site Name:	
Site Address:	
Site Coordinates:	
IDU Model:	
IDU Serial #	
ODU Model:	
ODU Serial #	
Site Access notes:	

Antenna Information

Antenna model	
Antenna size	
Height above Ground Level	
Does it meet Fresnel zone requirement?	Yes No
Antenna Mount is properly secure?	Yes No
Is the Antenna properly secure?	Yes No
Is the Mount Properly grounded?	Yes No
Is the Antenna Properly grounded?	Yes No
Is the Antenna side strut installed?	Yes No
Is the Antenna weather proof?	Yes No
Was the O-Ring installed properly?	Yes No

Outdoor Unit Information

Model of ODU :		
Direct or Remote ODU Mount	Direct	Remote
Are all four latches properly closed?	Yes	No
What is the ODU polarization?	H	V
Does the ODU look damaged?	Yes	No
Is the Gore Vent damaged?	Yes	No

Power Supply Information

Type of power Supply:		
Redundant power to the IDU?	Yes	No
Measure input voltage at IDU		(-VDC)
Properly grounded to the Earth?	Yes	No
Are the leads properly terminated to the power supply's terminal block	Yes	No

IF Cable Information

Cable type:	
Cable Length:	
Secure connection to the ODU?	
Secure connection to the IDU?	

Proper weather proofing at all necessary Points?	Yes	No	Remarks:
Point of entry properly weather proof?	Yes	No	
Point of entry properly grounded?	Yes	No	
Is there a drip loop at the ODU?	Yes	No	
Lightning suppressor at base of tower	Yes	No	Model:
Lightning suppressor at ODU	Yes	No	Model:
Is there any damage to the cable, bends, kinks, etc.?	Yes	No	Remarks:

Notes:

--

Installation Performed by:

Name:	Date:
Title:	Contact Number:
Company:	Signature:

Installation Approved by:

Name:	Date:
Title:	Contact Number:
Company:	Signature:

Link Configuration Log

Site A Information	
Customer:	
Site Name:	
Site Address:	
Site Coordinate:	
Site Configuration:	1+0/ 1+1 / 2+0 (Circle One)
Site Access notes:	

Complete after Link Configuration completed

Site A Configuration Performed by:	
Name:	Date:
Title:	Contact Number:
Company:	Signature:

Site A Configuration Approved by:	
Name:	Date:
Title:	Contact Number:
Company:	Signature:

Site A Unit #1 Information

Model of ODU	
ODU Serial Number	
IDU Serial Number	
IDU MAC Address	OBM: IBM:
IDU IP Address	OBM: IBM:
Polarization of this unit	V or H
Antenna Model	
Antenna Serial Number	
Transmit Frequency Setting	MHz
Transmit Power Setting	dBm
Speed/Modulation Setting	
Adaptive Coding & Modulation	ON / OFF
Automatic Transmit Power Control	ON / OFF
Target RSSI Setting	dBm
Recorded RSSI	dBm
Expected RSSI from PCN	dBm
Recorded MSE	dB
Linktest 99: stable RSSI, MSE, Lock?	Yes / No
24 Hour Traffic Test	No Errors –Pass / Errors: Fail
Utype	Active/Standby

Site A Unit #2 Information	
Model of ODU	
ODU Serial Number	
IDU Serial Number	
IDU MAC Address	OBM: IBM:
IDU IP Address	OBM: IBM:
Polarization of this unit	V or H
Combiner Model	
Combiner Serial Number	
Transmit Frequency Setting	MHz
Transmit Power Setting	dBm
Speed/Modulation Setting	
Adaptive Coding & Modulation	ON / OFF
Automatic Transmit Power Control	ON / OFF
Target RSSI Setting	dBm
Recorded RSSI	dBm
Expected RSSI from PCN	dBm
Recorded MSE	dB
Linktest 99: stable RSSI, MSE, Lock?	Yes / No
24 Hour Traffic Test	No Errors –Pass / Errors: Fail
Utype	Active/Standby

Site B Information	
Customer:	
Site Name:	
Site Address:	
Site Coordinate:	
Site Configuration:	1+0/ 1+1 / 2+0 (Circle One)
Site Access notes:	

Complete after Link Configuration completed

Site B Configuration Performed by:	
Name:	Date:
Title:	Contact Number:
Company:	Signature:

Site B Configuration Approved by:	
Name:	Date:
Title:	Contact Number:
Company:	Signature:

Site B Unit #1 Information	
Model of ODU	
ODU Serial Number	
IDU Serial Number	
IDU MAC Address	
IDU IP Address	OBM: IBM:
Polarization of this unit	V or H
Antenna Model	
Antenna Serial Number	
Transmit Frequency Setting	MHz
Transmit Power Setting	dBm
Speed/Modulation Setting	
Adaptive Coding & Modulation	ON / OFF
Automatic Transmit Power Control	ON / OFF
Target RSSI Setting	dBm
Recorded RSSI	dBm
Expected RSSI from PCN	dBm
Recorded MSE	dB
Linktest 99: stable RSSI, MSE, Lock?	Yes / No
24 Hour Traffic Test	No Errors –Pass / Errors: Fail
Utype	Active/Standby

Site B Unit #2 Information	
Model of ODU	
ODU Serial Number	
IDU Serial Number	
IDU MAC Address	
IDU IP Address	OBM: IBM:
Polarization of this unit	V or H
Combiner Model	
Combiner Serial Number	
Transmit Frequency Setting	MHz
Transmit Power Setting	dBm
Speed/Modulation Setting	
Adaptive Coding & Modulation	ON / OFF
Automatic Transmit Power Control	ON / OFF
Target RSSI Setting	dBm
Recorded RSSI	dBm
Expected RSSI from PCN	dBm
Recorded MSE	dB
Linktest 99: stable RSSI, MSE, Lock?	Yes / No
24 Hour Traffic Test	No Errors –Pass / Errors: Fail
Utype	Active/Standby

Appendix G – Declaration of Conformity

We, Trango Systems, Inc.,

14118 Stowe Drive
Ste B
Poway, California, 92127 USA
Tel +1 858 391-0010
Fax +1 858 391-0020

Hereby declare that the product(s) listed below,

Product Name: *TrangoLINK GigaPLUS Indoor Unit, 100Mbps Full Duplex, 1/2 U rack mnt*

Model No: *GIGAPLUS-IDU-1*

Product Name: *High Power Outdoor Unit 6-40 GHz*

Model No: *HP-XX-YYYY-ZZ, HP1-XX-YYYY-ZZ HP2-XX-YYYY-ZZ*

Where:

XX = the Frequency Band in GHz

YYYY= the T/R Spacing

ZZ= the Sub-band

To which this declaration relates, are in conformity with the following standards and/or other normative documents:

EN 302 217-2-2 (2007-04)

EN 302 217-2-1 (2005-08)

EN 301 489-17 v1.2.1 (2002-08)

EN 60950-1/IEC 60950-1:2001 First Edition

EN 50385: 2002

We hereby declare that all essential radio test suites have been carried out and that the above named products are in conformity with all the essential requirements of Directive 1999/5/EC.

The conformity assessment procedure referred to in Article 10(5) and detailed in Annex IV of Directive 1999/5/EC has been followed with the involvement of the following Notified Body using the CB Scheme:



Glossary

AGC	Automatic Gain Control
ATPC	Automatic Transmit Power Control
BER	Bit Error Rate
BPF	Band Pass Filter
Cat5e	Category 5 enhanced Cable
COS	Class Of Service
dB	Decibel
dBm	Decibel relative to one milliwatt
DSCP	Differentiated Services Code Point
E1	European-Carrier 1
FCC	Federal Communication Commission
FEC	Forward Error Correction
FPGA	Field Programmable Gate-Array
FTP	File Transfer Protocol
GigE	Gigabit Ethernet
HTTP	HyperText Transfer Protocol
HTTPD	HyperText Transfer Protocol Daemon
HTTPS	HyperText Transfer Protocol Secure
IF	Intermediate Frequency
IDU	Indoor Unit
LB	Loopback
LDPC	Low Density Parity Check
LED	Light-emitting Diode
LIU	Line Interface Unit
MSE	Mean Square Error
ODU	Outdoor Unit
Opmode	Operation Mode
OS	Operating System
PIC	A Series of microcontrollers a product of the Microchip Technology
PoE	Power Over Ethernet
QAM	Quadrature Amplitude Modulation
QoS	Quality of Service
QPSK	Quadrature Phase Shift Keying
RF	Radio Frequency
RJ-45	Registered Jack - 45
RS-232	Recommended Standard 232
RSSI	Receive Signal Strength Indicator
Rx	Receive
SFP	Small Form-factor Pluggable
SNMP	Simple Network Management Protocol
SSH	Secure Shell

Sysinfo	System Information
T1	1.544 Mbps telephony carrier 1
TDM	Time-Division Multiplexing
T/I	Threshold to Interference
TFTP	Trivial File Transfer Protocol
TFTPD	Trivial File Transfer Protocol Daemon
Tx	Transmit
VLAN	Virtual Local Area Network
WISP	Wireless Internet Service Provider
WRR	Weighted Round Robin