



# TrangoLINK<sup>®</sup> ApexPlus

6-40 GHz

All Outdoor High Capacity Point to Point Microwave Backhaul System



## User Manual

## Notice

This document contains information that is confidential and proprietary to Trango Systems, Inc. No part of the content of this publication may be reproduced, modified, used, copied, disclosed, conveyed, or distributed to any party in any manner whatsoever without prior written authorization from Trango Systems, Inc. This document is provided as is, without warranty of any kind.

## Trademarks

Trango Systems<sup>®</sup>, TrangoLINK<sup>®</sup>, and TrangoLINK Giga<sup>®</sup> are registered trademarks of Trango Systems, Inc. Other names mentioned in this publication are owned by their respective holders.

## Statement of Conditions

The information contained in this document is subject to change without notice. Trango Systems, Inc. shall not be liable for errors contained herein or for incidental or consequential damage in connection with the furnishing, performance, or use of this document or equipment supplied with it.

## Information to User

Any changes or modifications of equipment not expressly approved by the manufacturer could void the user's authority to operate the equipment and the warranty for such equipment.

Trango Systems, Inc.

Tel.: +1 (858) 391-0010

Fax: +1 (858) 391-0020

Copyright © Trango Systems, Inc. All rights reserved.

# Contents

Tables.....	9
Figures.....	10
Revision History .....	12
Preface.....	13
Reference conventions.....	14
Warranty Information .....	14
Contacting Trango Technical Support.....	14
Standards Compliance.....	15
<b>1.0 Product Description .....</b>	<b>16</b>
Overview.....	16
Ports and Indicators.....	18
Antenna Connection .....	21
Remote Mounting.....	21
Combiners for Antenna Sharing.....	21
Power Supply.....	21
Direct Power Option.....	22
Power Over Ethernet (PoE) Option.....	22
Key Features.....	23
Patent Pending Design .....	23
Traffic Capacity .....	23
Industry Leading System Gain.....	23
Full Licensed band frequency and T/R spacing support.....	25
Channel Sizes from 3.5 MHz to 80 MHz.....	25
Adaptive Coding and Modulation .....	26
Link Protection through 1+1 Hot Standby.....	27
<b>2.0 Wireless Operation Detail.....</b>	<b>28</b>
Channel Bandwidth .....	28
Modulation .....	28
Mean Squared Error (MSE) .....	28
Adaptive Coding and Modulation (ACM).....	30

Wireless Link Capacity.....	33
Automatic Transmit Power Control (ATPC).....	34
ATPC Max Power & Step Size .....	34
Transmitter Maximum Power Output.....	34
Transmitter Minimum Power output.....	35
Receiver Maximum Input .....	36
<b>3.0 Network Operation Detail .....</b>	<b>37</b>
1+0 Non-Protected Link Configuration .....	37
1+1 Hot Standby Protected Link Configuration.....	38
Hardware triggered failover .....	39
Software triggered failover.....	40
User triggered (manual) failover.....	40
Rapid Port Shutdown (RPS).....	41
VLAN Tagging.....	41
Port Mapping (802.1q) .....	42
Quality of Service (QoS) (802.1p and Diffserv).....	42
Port Priority.....	43
Port Rate Limiting (Ingress) .....	44
Egress Margin .....	44
<b>4.0 Link Management.....</b>	<b>45</b>
Overview.....	45
Graphical User Interface (Web Browser).....	46
Command Line Interface (CLI) using SSH, Telnet or Console .....	49
Changing Password.....	51
Console Port.....	52
Simple Network Management Protocol (SNMP).....	52
Common Objects for Monitoring and Control.....	53
Firmware Upgrade.....	54
Upgrade Procedure -TFTP.....	55
Upgrade Procedure -FTP.....	57
Capacity Upgrades.....	59
<b>5.0 Link Planning.....</b>	<b>60</b>
Frequency/Path Planning.....	60
Site Selection.....	60
Licensing .....	60
<b>6.0 Installation .....</b>	<b>61</b>
Safety.....	61

Installation Process .....	64
Preparing for Installation .....	64
Tools .....	64
Power Supply.....	65
Grounding Diagram.....	67
PoE Based Installation.....	68
PoE Based Installation (1+0).....	70
PoE Based Installation (1+1 Hot Standby).....	73
Direct Power Based Installation (1+0) .....	74
Direct Power Based Installation (1+1 Hot Standby) .....	74
ApexPlus ODU Installation on Antenna.....	75
Cable Installation.....	77
Antenna Installation.....	80
<b>7.0 Link Configuration .....</b>	<b>81</b>
Web Based Configuration.....	82
Web Based 1+0 Setup .....	82
Web Based 1+1 Setup .....	87
Adaptive Coding and Modulation (ACM) (Optional).....	88
Automatic Transmit Power Control (ATPC) (Optional).....	89
Command Line Interface (CLI) Based Configuration .....	90
CLI Based 1+0 Configuration .....	90
CLI Based 1+1 Hot Standby Configuration .....	96
Antenna Alignment .....	97
CLI Common Task Reference .....	99
Setting up the In-Band-Management (IBM).....	99
Capacity License Activation .....	101
Automatic Transmit Power Control (ATPC) Configuration (optional).....	101
Check Ethernet and RF port Statistics.....	102
Enable Traps (Optional).....	104
<b>8.0 Troubleshooting .....</b>	<b>106</b>
<b>Appendix A – Command Line Interface Reference.....</b>	<b>109</b>
Command Keying Overview .....	109
Key Functions.....	109
Different Node Levels.....	110
View Node.....	110
Config Node.....	112
Debug Node .....	117
Individual Command Details.....	118

acm	118
atpc	119
ber	120
bootimage	120
config	121
cos	122
datapath (future)	123
datapattern	124
date	124
debug	124
default_opmode	125
diagnostic	126
egress_margin	126
exit	127
failover	127
freq	128
freq_duplex	129
ftp	129
guard_time	131
help / ?	132
httpd	132
ibm	133
ipconfig	134
license	134
link_history	135
linktest	135
loglevel	136
loopback	136
model	137
mse	138
odupower	139
opmode	139
passwd	140
port	140
power	141
prompt	142
qos	142
reboot	143
reload	143
remark	144

reset.....	144
rps.....	145
rss.....	146
show.....	146
siglevel.....	147
smart_mode.....	148
snmpd.....	148
speed.....	149
status.....	150
sync.....	150
sync_status.....	151
sysinfo.....	152
syslog.....	152
targetrss.....	153
tdm.....	153
telnetd.....	154
temp.....	154
ftpd.....	155
threshold.....	155
trap.....	157
uptime.....	157
utype.....	158
utype_switch.....	159
version.....	160
voltage.....	160
web_refresh_rate.....	160

**Appendix B – Product Specifications .....162**

Dimensions and Weight.....	162
Environmental.....	162
Emissions.....	162
Reliability.....	163
Electromagnetic Compliance.....	163
Wireless Compliance.....	163
Wireless Parameters.....	164
Transmitter Power.....	164
1+1 Hot Standby Link Protection.....	166
Specification.....	166
Power.....	166
User Interfaces.....	166

Ethernet Parameters.....	167
T1/E1 Parameters.....	167
<b>Appendix C – Cable Wiring .....</b>	<b>168</b>
Ethernet Cabling.....	168
Console Port Cabling.....	169
<b>Appendix D – MIB OID Listing.....</b>	<b>170</b>
<b>Appendix E – Part Numbers .....</b>	<b>176</b>
ApexPlus Sub-bands/Tuning Ranges.....	176
Accessories.....	188
<b>Appendix F – Link Install and Commissioning Logs.....</b>	<b>189</b>
<b>Appendix G – Declaration of Conformity.....</b>	<b>200</b>
<b>Glossary .....</b>	<b>201</b>



## **Tables**

Table 1: TrangoLINK® ApexPlus part numbers.....	13
Table 2 Combiner Cross Reference.....	21
Table 3 ApexPlus Band and T/R Spacing Options.....	25
Table 4 MSE Expected and Maximum Values.....	29
Table 5 ACM Threshold Table.....	31
Table 6 Max Link Capacity (Mbps) for non-ACM Speed Settings.....	33
Table 7 Maximum Set Power Levels by Band and Modulation.....	35
Table 8 Minimum TX set power by band.....	35
Table 9 Max Receive Level Input.....	36
Table 10 Failover Events.....	39
Table 11 Default Login Passwords.....	46
Table 12 RSSI to Voltage Conversion.....	98

## **Figures**

Figure 1 OMU Functional Block Diagram.....	16
Figure 2 ODU Functional Block Diagram .....	17
Figure 3 ApexPlus Ports and indicators.....	18
Figure 4 Polarization Indicator .....	20
Figure 5 Product Label .....	20
Figure 6 LDPC vs. Reed-Solomon Coding .....	24
Figure 7 Adaptive Coding and Modulation (ACM) .....	26
Figure 8 1+0 Setup.....	37
Figure 9 1+1 Setup.....	38
Figure 10 Web Browser Login .....	46
Figure 11 System Info Page .....	47
Figure 12 Console Port Setting .....	52
Figure 13: Windows Start & Telnet.....	55
Figure 14 Capacity Upgrade – Web .....	59
Figure 15- 48 VDC Power Connector using Coaxial Cable and 16 AWG Cable.....	66
Figure 16 PoE Based Grounding Diagram .....	67
Figure 17 POE-GIGE-48.....	68
Figure 18 POE-GIGE-48 Internal wiring .....	69
Figure 19 1+0 / IBM PoE Wiring .....	70
Figure 20 1+0 / OBM PoE Wiring .....	71
Figure 21 1+0 PoE Redundant Wiring.....	72
Figure 22 Direct Power Wiring.....	74
Figure 23 Antenna to ApexPlus Slip Fit Waveguide connection .....	75

Figure 24 Polarization Indicator .....	76
Figure 25 Latches .....	76
Figure 26 Port Sealing Components .....	77
Figure 27 STP Cables installed on Unit.....	77
Figure 28 Detail of the Stainless Steel Thumbscrew .....	78
Figure 29 Strain Relief Exploded View.....	78
Figure 30 Strain Relief Installed.....	79
Figure 31 Ground Lug on OMU.....	79
Figure 32 Web Interface Login .....	82
Figure 33 Web Login with Password.....	82
Figure 34 System Status- Version Page.....	83
Figure 35 Link Setup Page.....	86
Figure 36 Failover Mode Set.....	87
Figure 37 ACM Setup.....	88
Figure 38 ATPC Setup/ RPS /Telnetd/ tftpd.....	89
Figure 39 BNC Connector for RSSI Voltage .....	97
Figure 40 EIA/TIA 568A Straight through.....	168
Figure 41 EIA/TIA 568B Cross-Over.....	168
Figure 42: ApexPlus Serial Cable Pin-Out.....	169

## Revision History

Revision	Revision Date	Description
1.0	4 Apr 2011	Initial Release
3.0	5 May 2012	<p>Update to reflect the following feature changes in SW V3.0 plus bug fixes (see release note for bug fixes)</p> <ul style="list-style-type: none"> <li>- Allow IBM without a VLAN on AP-OMU-1 HWID 2 models</li> <li>- Custom Speed Profile Support</li> <li>- Support for 5, 8.33, 12.5, and 25 MHz channels sizes</li> <li>- Diffserv (DSCP) and weighted QoS on a per port basis</li> <li>- Individual Ethernet Port utilization Statistics</li> <li>- SNMP OID harmonization with GigaPlus 3.0</li> <li>- Remote Link status reporting</li> <li>- Two level access web interface (view/ config)</li> <li>- Web look and feel changes</li> <li>- Auto loopback diagnostic</li> <li>- Add "link down" threshold parameter</li> <li>- Link Status recording and comparing diagnostic</li> <li>- Reload/reboot in x seconds</li> <li>- Linktest added to web</li> <li>- Web page refresh rate control</li> <li>- BER calculation improvement</li> <li>- Eth port loopback diagnostic</li> <li>- Remove limitation of turning opmode off for a freq change</li> </ul> <p>Add note regarding hardware compatibility by revision            Update Table 3 to add new 7 and 13 GHz TR s            Add note about PoE Voltage range and grounding            Updated Figure 22 Direct Power Input            Login via web config mode</p>

## Preface

This manual covers the configuration and installation of the TrangoLINK® ApexPlus licensed microwave backhaul system,

This document is intended to instruct and assist personnel in the operation, installation and maintenance of the TrangoLINK® ApexPlus microwave backhaul system and related accessories shown in Table 1.

It is recommended that all personnel engaged in such activities be properly trained. Trango Systems disclaims all liability whatsoever, implied or express, for any risk of damage, loss or reduction in system performance arising directly or indirectly out of the failure of the customer, or anyone acting on the customer's behalf, to abide by the instructions, system parameters, or recommendations made in this document.

Part Number	Description
TLAP1-XX-YYYY-Z	TrangoLINK® ApexPlus HP system, XXGHz, YYYY Duplex, Subband Z
TLAP2-XX-YYYY-Z	TrangoLINK® ApexPlus HP2 system, XXGHz, YYYY Duplex, Subband Z
AP1-XX-YYYY-ZZ	TrangoLINK® ApexPlus HP All Outdoor Unit, XXGHz, YYYY Duplex, Subband ZZ
AP2-XX-YYYY-ZZ	TrangoLINK® ApexPlus HP2 All Outdoor Unit, XXGHz, YYYY Duplex, Subband ZZ
PSUPPLY-DT-48	-48 Volt Universal Desktop Power Supply
PSUPPLY-1U-48	-48 Volt Universal Rack mount Power Supply
POE-GIGE-48	PoE injector/Surge Suppressor for ApexPlus
CBLDAT-4	Serial Console Cable for ApexPlus
CBLDAT-RIU4	1+1 Hot Standby Cable for ApexPlus
CBLDAT-RSSI	BNC-M to Banana plug cable for RSSI voltage measurement
AP-KEY-1	Software Key to Allow Throughputs up to 200Mbps
AP-KEY-2	Software Key to Allow Throughputs up to 375Mbps
AP-KEY-3	Software Key to Allow Higher Transmit Power for 11-23 GHz on AP1 models
SFP-GigE-C	SFP 1000BaseT Copper RJ45
SFP-GigE-S	SFP Fiber Single Mode Module
SFP-GigE-M	SFP Fiber Multi Mode

Table 1: TrangoLINK® ApexPlus part numbers

Specific part numbers for radio unit sub-bands and band specific accessories such as antennas, combiners and remote mounts can be found in Appendix E.

## ***Reference conventions***

This document utilizes several conventions.

All system command references are shown in ***bold italics***.

All references to external publications are shown in **bold**.

## ***Warranty Information***

TrangoLINK® ApexPlus units purchased from Trango Systems, Inc. are warranted for one year from date of purchase. Please see [www.trangosys.com](http://www.trangosys.com) for a complete description of warranty coverage and limitations.

Extended warranty protection can be purchased through Trango Sales or Customer Service (+1 858-391-0010).

## ***Contacting Trango Technical Support***

Should assistance be required or an RMA be required, you may contact the technical support department using the following methods:

**Phone:** (858) 391-0010 from 8 am to 5 pm Pacific Standard Time.

**Email:** [techsupport@trangosys.com](mailto:techsupport@trangosys.com)

**Web:** [www.trangosys.com](http://www.trangosys.com)

# Standards Compliance

## Federal Communications Commission (FCC)

ANSI models of the TrangoLINK® ApexPlus product line have been tested and found to comply with the following FCC standards:

### CFR47 Part 15

### CFR 47 Part 101

Appendix E shows the specific part numbers that have been tested.

## Federal Communications Commission (FCC) Emission Designators

- 5M0D7W for 5 MHz BW rates and all modulations
- 8M3D7W for 8.33 MHz BW rates and all modulations
- 10M0D7W for 10 MHz BW rates and all modulations
- 12M5D7W for 12.5 MHz BW rates and all modulations
- 20M0D7W for 20 MHz BW rates and all modulations
- 25M0D7W for 25 MHz BW rates and all modulations
- 30M0D7W for 27.5/28/30 MHz BW rates and all modulations
- 40M0D7W for 40 MHz BW rates and all modulations
- 50M0D7W for 50 MHz BW rates and all modulations
- 56M0D7W for 55/56/80 MHz BW rates and all modulations

## European Telecommunications Standards Institute (ETSI)

ETSI models of the TrangoLINK® ApexPlus product line have been tested and found to comply with the European Telecommunications Standards:

- **EN 302 217-2-1 V1.2.1 (2007-02)**
- **EN 302 217-2-2 V1.2.2 (2007-04)**
- **EN 301 489-1 V1.8.1 (2008-04)**
- **EN 301 489-4 V1.4.1 (2008-09)**
- **EN 60950-1**



These standards cover all the essential requirements of Directive 1999/5/EC. Appendix E shows the specific part numbers that have been tested.

## RoHS Compliance

The TrangoLINK® ApexPlus product line complies with the European Union (EU) Directive 2002/95/EC on the Restriction of Hazardous Substances (RoHS).



# 1.0 Product Description

## Overview

The TrangoLINK® ApexPlus is a high-performance all outdoor point-to-point wireless microwave system designed for Carrier, Enterprise, and Service Provider networks using the 6-40 GHz licensed spectrum. The system provides a full duplex wireless Layer 2 Ethernet connection with ultra low packet latency and jitter, and supports both 10/100/1000BaseT and Fiber interfaces, as well as T1/E1 interfaces for timing or legacy TDM support.

The unique design of the ApexPlus was created to allow the highest performance possible across all standard frequency bands and TR spacings, best heat dissipation for operation in warm climates, and easy sparing options for larger networks. Each unit consists of an Outdoor Modem Unit (OMU) and an Outdoor RF unit (ODU), connected via a single coaxial cable. Figures 1 and 2 show the functional block diagram of the system as they are divided between the OMU and ODU.

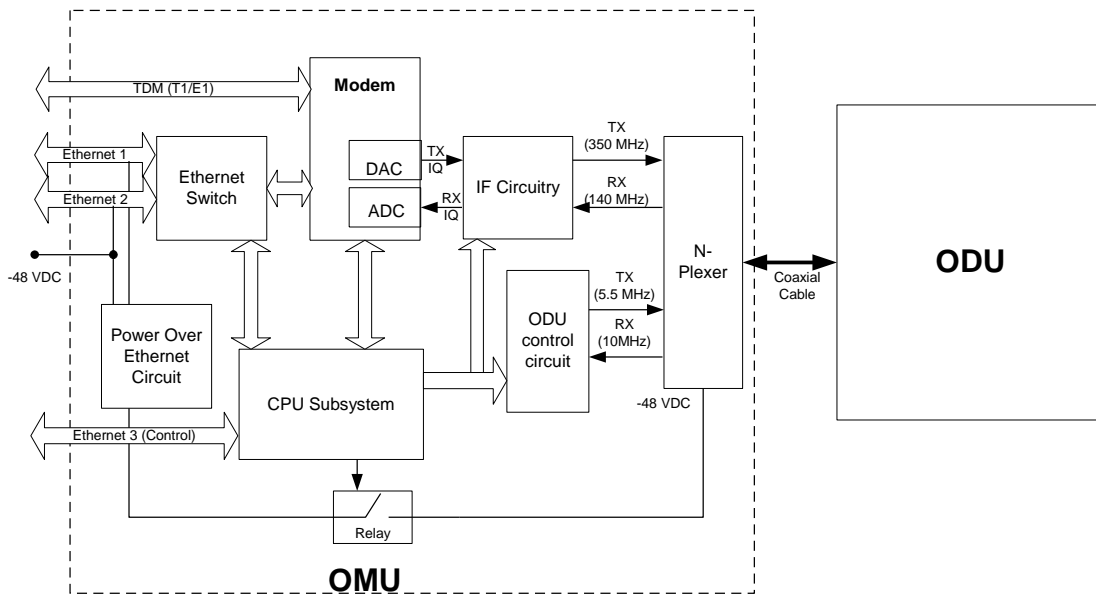

Figure 1 OMU Functional Block Diagram



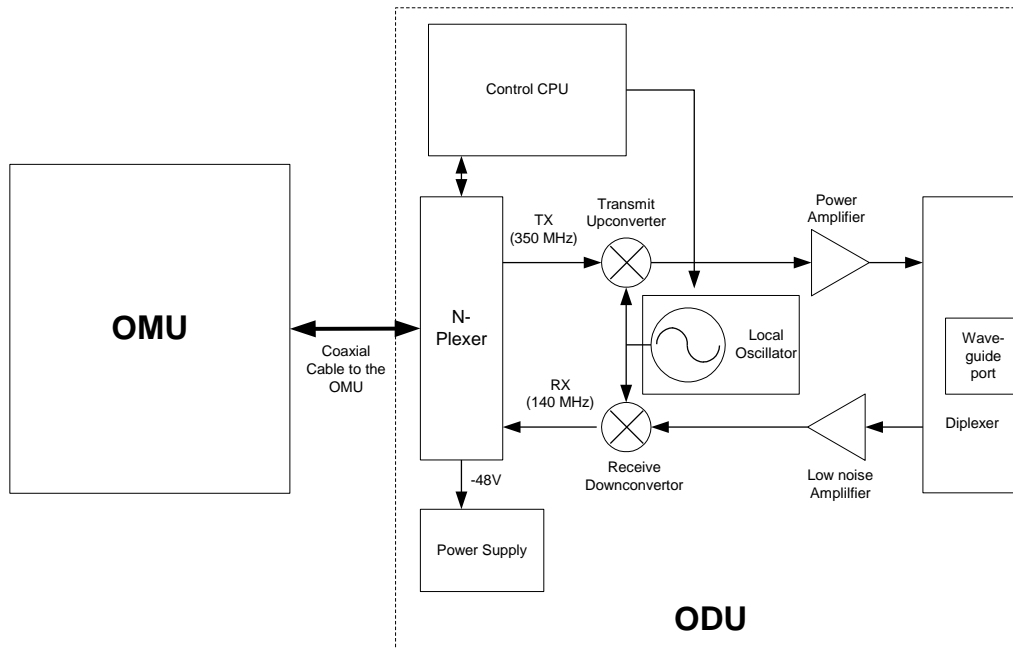

Figure 2 ODU Functional Block Diagram

The TrangoLINK® ApexPlus is a Frequency Division Duplex (FDD) radio which can provide low latency of less than 150 microseconds ( $\mu\text{s}$ ), over 1 million packets per second, and up to 375 Mbps of full duplex capacity. Standard features include Quality-of-Service (QoS) traffic prioritization to ensure that critical traffic gets through, Hitless Adaptive Coding and Modulation (ACM) and Adaptive Transmit Power Control (ATPC) to improve performance during weather related signal degradation.

ApexPlus supports either direct -48 Volt DC power or power over Ethernet using a PoE injector device provided by Trango. The PoE injector has interfaces for Ethernet, T1/E1 traffic and management, as well as support for redundant power supplies.

## Ports and Indicators

The Figure below shows the various ports on the ApexPlus Unit.

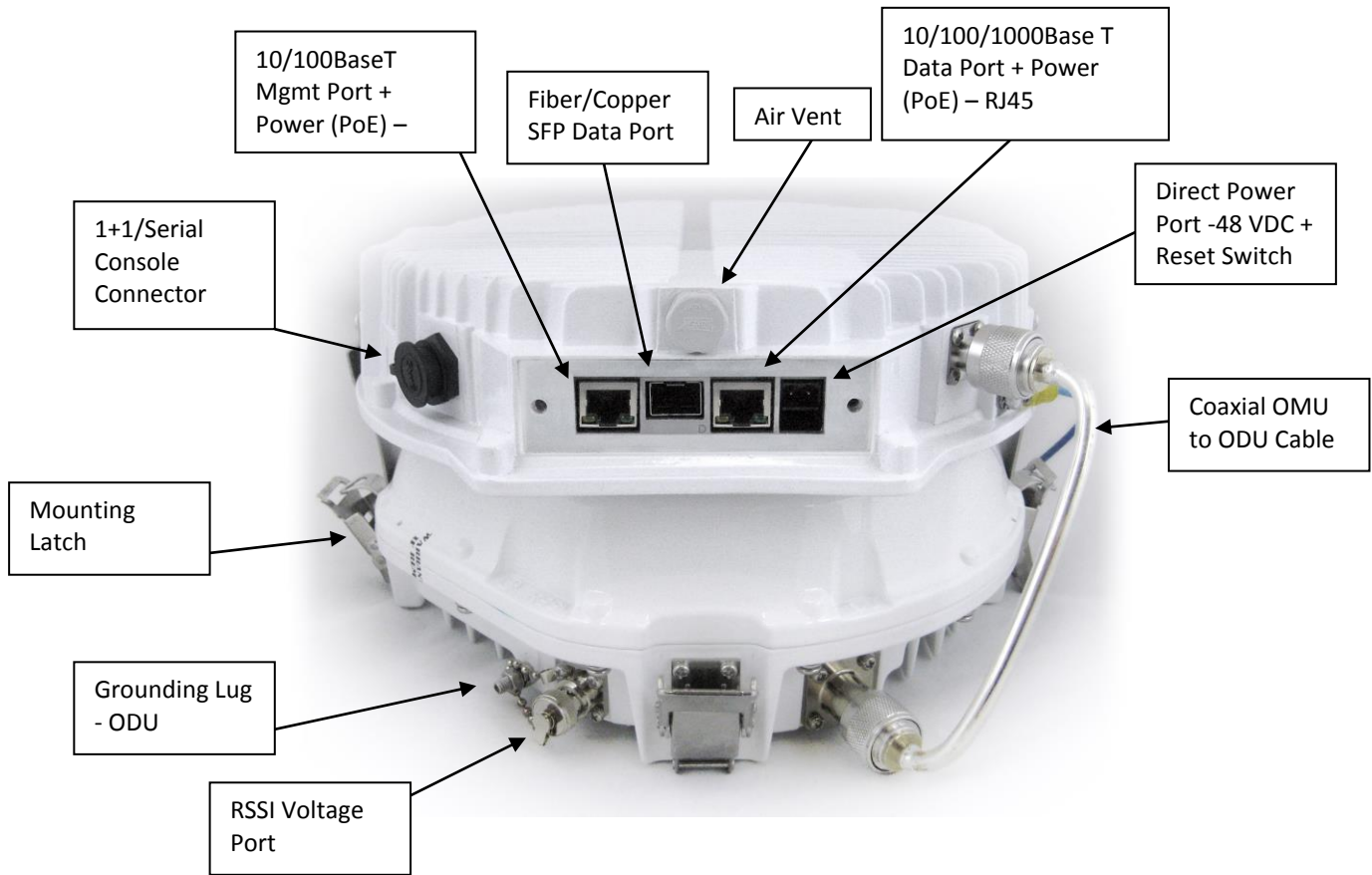

Figure 3 ApexPlus Ports and indicators

**10/100/1000BaseT RJ45 Connector** - This is the main native Ethernet data port.

**SFP Port** – SFP Port supports a second native 1000BaseT or LC fiber Ethernet connection for traffic. SFP modules are available to support each as follows:

- SFP-GigE-C – Copper RJ45 module to support 1000BaseT
- SFP-GigE-S – Single Mode Fiber for long haul
- SFP-GigE-M– Multimode Fiber for short haul

**10/100BaseT RJ45 Connector** – For Out of band Web, SNMP, Telnet, and SSH management. Also multiplexed as a native T1/E1 Interface to support TDM traffic when using the PoE Injector PoE-GigE-48.

**Direct Power Terminal Block** – this terminal block supports direct powering of the unit using -48 Volt DC power.

**1+1 Hot Standby LED** – This LED indicates the following conditions related to the 1+1 hot standby operation.

- 1) A backup unit has been detected (solid).
- 2) The 1+1 mode is active (blinking).

**Reset Switch** – The Reset switch operates as follows:

- 1) Hold for more than 2 seconds, but less than 6 seconds, the unit will:
  - a. The IP address will be reset to default to allow access in the event of a forgotten password or IP address.
  - b. The CLI management passwords will be reset to default
  - c. The Web interface passwords will be reset to default.
  - d. The SNMP read/write/trap community strings will be set to defaults.
  - e. The CLI prompt will be reset.
- 2) Hold for more than 6 seconds: The unit will reset the system configuration to the factory default, but **NOT** reset the items it (1) above. The unit **WILL REBOOT** automatically.

**1+1/Serial Console Connector** – When using 1+1 Hot Standby with a combiner and second identical ApexPlus, cable CBLDAT-RIU4 is connected between this connector on both units to allow critical timing and communication between the OMU during 1+1 hot standby operation.

**Gore™ Air Vent** – The air vent is present to provide pressure equalization at high altitudes while preventing moisture from entering the unit. No operator interaction is necessary.



**DO NOT TAMPER with the Air Vent. It should not be twisted or removed. Tampering with or damaging the Protective Vent will void the factory warranty.**

**RSSI Voltage BNC-F Connector** – This connector is provided to allow easy antenna alignment when used with a multi-meter and the CBLDAT-RSSI cable. The Voltage present on the connector is directly proportional to the Received Signal Strength in the receiver section of the ApexPlus.

**OMU to ODU cable**– This cable carries the Transmit IF signal, Receive IF signal, supply voltage, and control signaling to the ODU. The cable is sealed using heat shrink to prevent water ingress and should only be changed by Trango factory certified personnel.

**Mounting Latches** – Four latches are provided to allow easy attachment of the ApexPlus to the standard antennas, combiners and remote mounts. Two of the latches have keyholes to allow locking the unit to deter theft and/or secure the unit.

**Polarization Indicators** – The letters “H” and “V” are die cast on the OMU housing perimeter to assist in mounting the ApexPlus to the antenna in the correct polarization. The letter that is at the top will always indicate the antenna polarization being utilized.

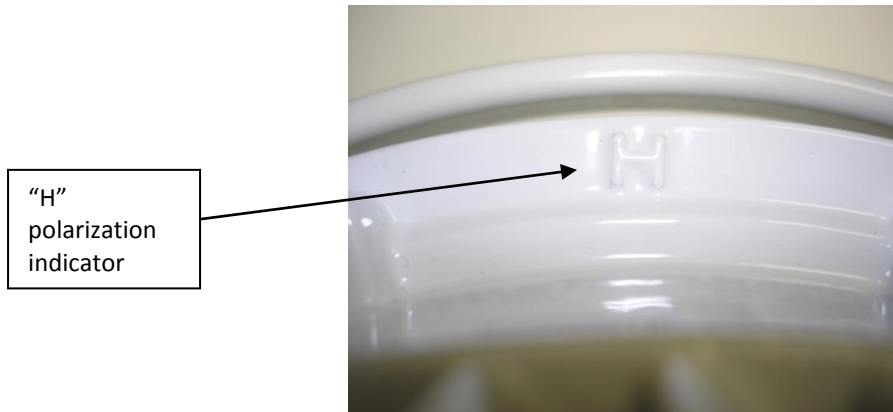

Figure 4 Polarization Indicator

**Grounding Lug – OMU** – The ground lug provided on the OMU should be connected to the tower/structure leg per the grounding section recommendations.

**Grounding Lug – ODU** - The ground lug provided on the ODU should be connected to the tower/structure leg per the grounding section recommendations.

**Labels** – The Serial numbers and MAC address, along with the regulatory compliance information are shown on the ODU labels attached to the ODU and OMU exterior.

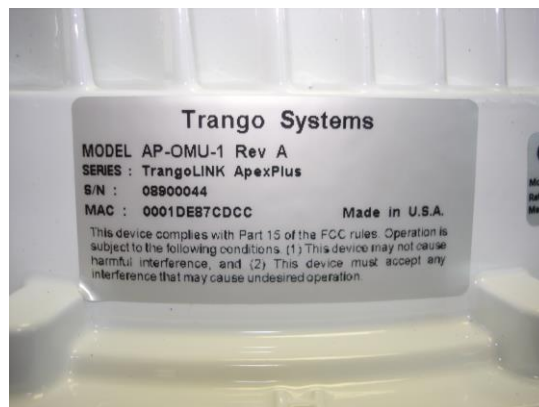

Figure 5 Product Label

## Antenna Connection

The ODU portion of the ApexPlus utilizes a slip fit connection that makes installation simple. The ODUs are all designed to mount to a circular waveguide antenna or combiner with the exception of the 6 GHz models. For 7 to 40 GHz models, simply rotating the ApexPlus will change the antenna polarization being used. A compatibility list of antennas is provided in Appendix E.

## Remote Mounting

When using the ApexPlus with non-Trango antennas, a Remote Mount plus flex waveguide may be needed. The compatible remote mounts are shown in Appendix E. The waveguide flanges are available for mounting all standard waveguide sizes.

## Combiners for Antenna Sharing

The ApexPlus unit is designed with an easy slip fit interface to the antenna. If desired, two units may be connected to the same antenna for 1+1 hot standby application or to aggregate two channels for more capacity. Trango can provide multiple combiner options based on the customer applications as the table shows below:

Model	LOSS (dB)	LOSS (dB)	ODU1=H	ODU1=H	ODU1=V
	ODU1	ODU 2	ODU2=V	ODU2=H	ODU2=V
SMC-06-xx	1.9	6.5		●	●
SMC-03-xx (6-23 GHz)	3.3	3.3		●	●
SMC-03-xx (26-38 GHz)	4.1	4.1		●	●
OMC-xx	0.5	0.5	●		

Table 2 Combiner Cross Reference

Appendix E gives detailed information on which specific frequency bands are supported for each type of combiner.

## Power Supply

Trango can provide power supplies for rack mount and desktop applications. The PSUPPLY-1U-48 is a rack mount power supply with 6.5 Amp capacity that can support multiple co-located ApexPlus units. The PSUPPLY-WM-48-L is a wall mount power supply with 1.5 Amp capacity and is only recommended for a single ApexPlus unit. The power supply must be kept in a temperature controlled environment within the operating temp of 0 to 40 deg C.

## **Direct Power Option**

The ApexPlus can be direct powered using a -48 Volt DC source with a terminal block connection at the unit. The length of the cable varies on the gauge of the wire being used, but in general longer distances can be achieved than using the PoE option since the voltage drop is less. As long as the minimum voltage is maintained at the ApexPlus unit, the system will operate. This option is also preferred for applications using fiber for the data

## **Power Over Ethernet (PoE) Option**

When utilized with a POE-GIGE-48 PoE injector, the ApexPlus can be powered over the same Cat5e/Cat6 Shielded Twisted Pair (STP) that is used for the Data and in-band management connection. Surge suppression and provision for redundant power supplies are provided with a single POE-GIGE-48 device.

## Key Features

### Patent Pending Design

The ApexPlus is the first all outdoor microwave system to utilize two piece architecture consisting of an outdoor Modem Unit (OMU) and an Outdoor Radio Unit (ODU). This unique design has several benefits:

- 1) Support for all licensed frequencies from 6-40 GHz via a common IF/telemetry/power interface.
- 2) Improved temperature performance due to the increased surface area of the unit.
- 3) Common ODUs with Trango GigPlus and GigaPro split architecture systems to simplify field sparing requirements.
- 4) System Gain equivalent to Trango Split architecture systems, among the highest in the industry.

### Traffic Capacity

With QAM256 modulation in a 56 MHz channel, the link can support capacities up to 375 Mbps full duplex or 750 Mbps aggregate, with an additional T1 circuit provided for timing or TDM applications.

The base model comes with 100 Mbps full duplex capacity and there are two upgrade keys available that can open the entire 375 Mbps capacity:

#### ***AP-Key-1***

Description: Unlocks throughput capacity from 100 up to 200 Mbps Full Duplex payload (200 Mbps each direction) – Covers one link – (2 license keys provided)

#### ***AP-Key-2:***

Description: Unlocks throughput capacity from 100 Mbps up to Maximum capacity Full Duplex payload (375 Mbps each direction) – Covers one link – (2 license keys provided)

### Industry Leading System Gain

The combination of the High Transmit power and superb receive sensitivity of the ODU provide for one of the highest system gains available on the market today.

The technology behind the high system gain relates to the Low Density Parity Check (LDPC) forward error correction (FEC) coding that was implemented in the ApexPlus design.

The Figure below shows how the Low Density Parity Check (LDPC) coding, which replaces the older Reed-Solomon lock coding, reduces the signal to noise ratio required to achieve a 1E-6 Bit Error Rate (BER). As a result, the receive sensitivity is lowered by the same amount, typically 3 to 4 dB.

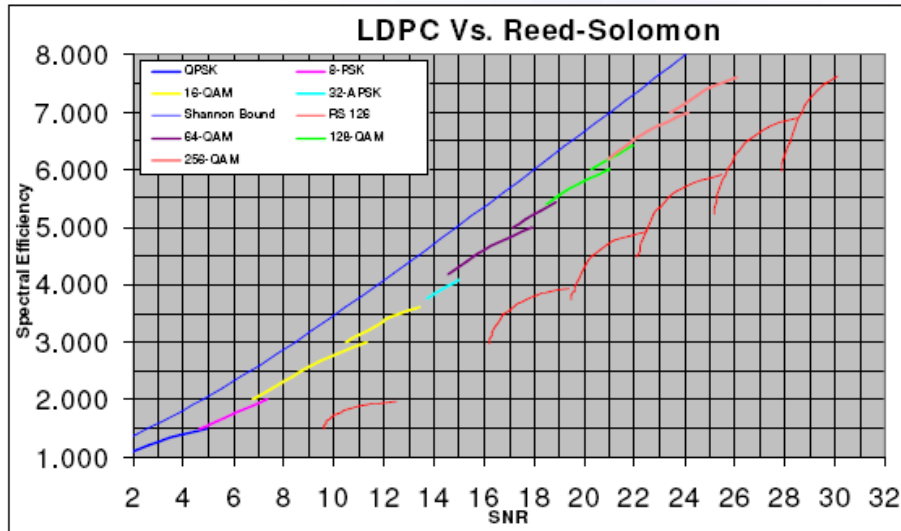

\* SNR is for BER of 1e-6

Figure 6 LDPC vs. Reed-Solomon Coding

System gain is one of the most important metrics for a microwave system because it has a direct relationship to the link reliability, antenna size, and transmission distance as shown in the figure below.

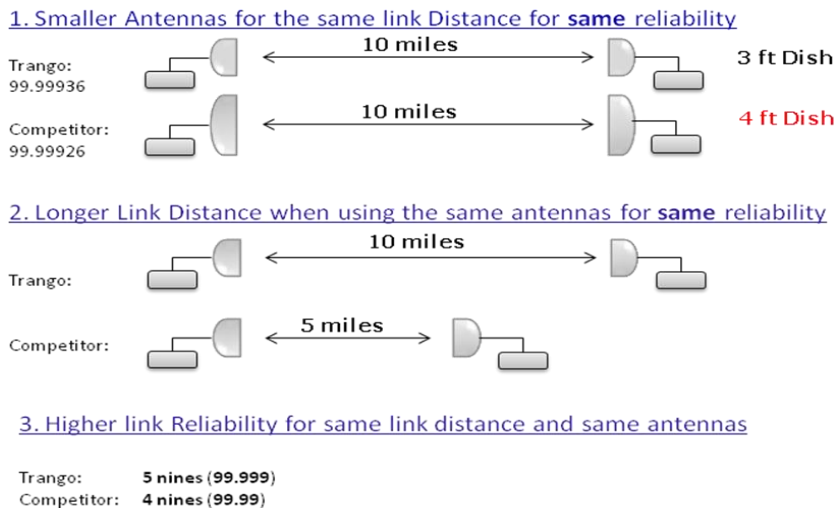



## Full Licensed band frequency and T/R spacing support

Due to the unique design, all standard frequency bands and T/R spacings are available for this product with no long product rollout delays. The Figure below shows the currently supported band and T/R spacings for ApexPlus, with the numbers representing the number of sub-bands for each frequency band. ApexPlus is available in two base models, AP1-XX-YYYY-ZZ, which utilizes the HP ODUs and AP2-XX-YYYY-ZZ, which utilizes HP2 ODUs.

Models	6 GHz						7 GHz						8 GHz				10 GHz	11 GHz						
	TR Spacing																							
	160	170	240	252.04	300	340/350	150	154	160	161	168	196	245	300	119/126	151.614	208	266	310	311.32	360	350	490/500	530
AP1/HP1 ODU	2	2	3	3	4	2	3	3	16	3	5	3	3	6	3	4	2	3	2	3	3	3	3	4
AP2/HP2 ODU	4	4		4	4	4	2	3	3	16	3	5	3	6		4	2		2		1	3	3	4
Common sub-banding							●	●	●	●	●	●		●		●	●		●			●	●	●

Models	13 GHz			15 GHz								18 GHz		23 GHz		26 GHz		28 GHz		32 GHz	38 GHz		42 GHz		
	TR Spacing																								
	200	225	266	315	315/322	420	475	490	640	644	728	1010/1008	1092.5/1120	1560	1008	1200	1232	800	1008	450	1008	812	700	1260	1500
AP1/HP1 ODU	4	5	4		3	4	3	4	2	3	1	4	3	1	2	3	4	1	3		2	2	4	2	2
AP2/HP2 ODU		3	4	3		4	3	4	2	3	1	4		1	2	3	4	1	3	3	2	2	4	2	
Common sub-banding			●			●	●	●	●	●	●	●		●		●	●	●			●	●	●	●	

Table 3 ApexPlus Band and T/R Spacing Options

Specific information on the sub-bands is shown in Appendix E.

For AP1 models the TR spacing can be customized via a software command as long as the new TR spacing and channel bandwidths are within the diplexer range. See Appendix E for more information

### Channel Sizes from 3.5 MHz to 80 MHz

Across all the frequency bands, the system can support channel sizes as low as 3.5 MHz. The channel sizes are user selectable. Table 6 shows the maximum Ethernet capacities for each symbol rate and modulation level.

In addition, custom speed profiles can be added to replace the existing speed profiles. This allows optimization of various system parameters such as latency, sensitivity, and traffic capacity. Contact Trango Sales for more information.

### Adaptive Coding and Modulation

Adaptive coding and modulation provides error-free hitless changing of the modulation level for a fixed channel width to allow the link to be maintained during heavy weather related fading conditions. Instead of the link dropping and no traffic passing, the link will be maintained with a lower capacity until the fading condition is removed, at which time the link will return to the normal modulation level.

The transitions between modulation levels are controlled by thresholds which are user-modifiable and each transition is made without dropping packets since both ends of the link coordinate the transition automatically.

The Figure below shows the Adaptive Coding and modulation in action.

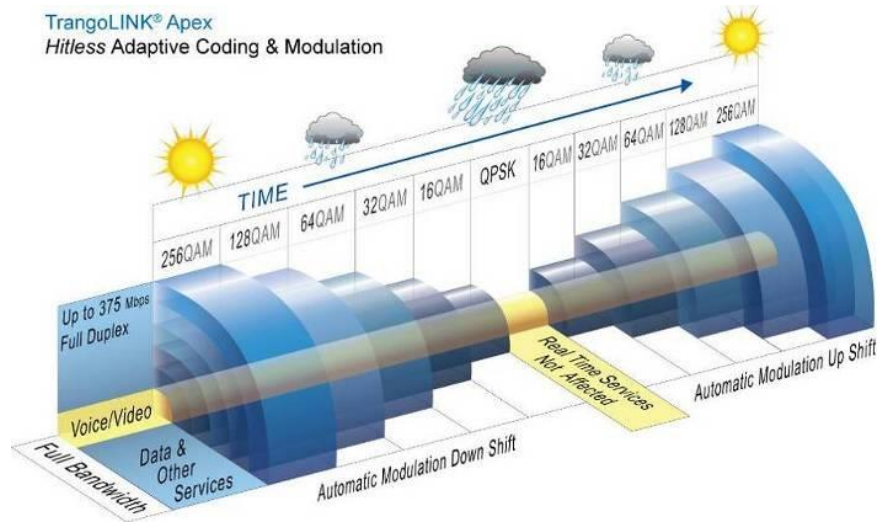

Figure 7 Adaptive Coding and Modulation (ACM)

### **Link Protection through 1+1 Hot Standby**

Two ApexPlus units can be mounted using a combiner directly on a single antenna , and with an optional short jumper cable between the two units, provide 1+1 hot standby functionality to protect against a hardware failure of the one ApexPlus unit or a cable failure.

The hot-standby feature is available on all frequencies and can support layer 2 and layer 3 routed networks to allow immediate routing of the signal to the standby link. The failover time is typically less than 200 milliseconds.

## 2.0 Wireless Operation Detail

### Channel Bandwidth

The system supports the following channel bandwidths:

3.5 MHz	25 MHz
5.0 MHz	27.5/28 MHz
7 MHz	30 MHz
8.33 MHz	40 MHz
10 MHz	50 MHz
12.5 MHz	55/56 MHz
13.75/14 MHz	80 MHz
20 MHz	

The Speed is changed via the management interface using the speed command or a drop down box in the web interface. Both sides of the link must be changed independently to ensure the RF link is established.

### Modulation

The following modulation levels are supported within each of the channel bandwidths shown above:

QAM256  
QAM128  
QAM64  
QAM32  
QAM16  
QPSK

The modulation is changed via the management interface using the speed command or a drop down box in the web interface. Both sides of the link must be changed independently to ensure the RF link is established.

### Mean Squared Error (MSE)

Mean Square Error (MSE) is similar to Signal-to-Noise Ratio (SNR) except that it accounts for **distortion** and **interference** in addition to noise power.

*Distortion* may come from several sources such as bad Ethernet cables (poor shield, damaged, or low quality), path degradations such as multipath, or Fresnel zone encroachment.

*Interference* can come from other transmitters on the tower, as well as from sources inside an indoor shelter. High power transmitters inside a shelter can cause interference when near the PoE device or when located very close to the cabling.

There are maximum acceptable MSE values for each modulation which are useful in determining the quality of the link. The MSE value reported is only relevant to one tx-rx path, so the MSE of each tx-rx path must be evaluated to verify the link is operating as expected. The lower the number the better, so a -35dB is better than a -30dB. The table below shows the maximum MSE value to expect in IF Loopback, Normal Operation, and Absolute Maximum.

<b><i>MSE Expected and Maximum Values (dB)</i></b>						
	QAM256	QAM128	QAM64	QAM32	QAM16	QPSK
Maximum Expected value IF loopback	-36	-36	-36	-36	-36	-36
Maximum Expected value Normal operation at max power	-34	-33	-32	-30	-30	-29
Absolute Maximum for 1E-6 BER Sensitivity Threshold	-28	-25	-22	-19	-16	-9

Table 4 MSE Expected and Maximum Values

## Adaptive Coding and Modulation (ACM)

The ACM feature works in conjunction with the Mean Square Error (MSE) values. Using the **acm** command, the operator enables the ACM function and then sets the speed using the speed command. When ACM is enabled (on) and the link MSE becomes degraded, the radio will automatically shift down in modulation and speed based on the MSE degrade threshold setting shown in Table 5. Since the original set modulation may be QAM256, QAM128, QAM64, QAM32, or QAM16, the table shows each setting and total range of modulation levels that will be used for that setting. The threshold values can be changed by the operator if desired, however the default values shown have been thoroughly tested and are the recommended settings.

<b>Speed Setting QAM256</b>		
<b>Modulation</b>	<b>Improve</b>	<b>Degrade</b>
QAM256	-32.1	-27.2
QAM64	-29.2	-24.3
QAM16	-25.3	-18.5
QPSK	-20.3	-17.1
<b>Speed Setting using QAM128</b>		
<b>Modulation</b>	<b>Improve</b>	<b>Degrade</b>
QAM128	-32.1	-27.2
QAM64	-29.2	-24.3
QAM32	-26.3	-21.3
QAM16	-25.3	-18.5
QPSK	-20.3	-17.1
<b>Speed Setting using QAM64</b>		
<b>Modulation</b>	<b>Improve</b>	<b>Degrade</b>
QAM64	-29.2	-24.3
QAM32	-26.3	-21.3
QAM16	-25.3	-18.5
QPSK	-20.3	-17.1
<b>Speed Setting using QAM32</b>		
<b>Modulation</b>	<b>Improve</b>	<b>Degrade</b>
QAM32	-26.3	-21.3
QAM16	-25.3	-18.5
QPSK	-20.3	-17.1
<b>Speed Setting using QAM16</b>		
<b>Modulation</b>	<b>Improve</b>	<b>Degrade</b>
QAM16	-25.3	-18.5
QPSK	-20.3	-17.1

Table 5 ACM Threshold Table



The ACM feature will automatically shift the modulation level up or down based on the MSE value and the above specified thresholds. If you do not want the radio to change speed settings then disable ACM.

## ACM Detailed Description

If the channel conditions degrade due to multipath or fading, the signal strength and consequently the MSE may be affected. This typically occurs during heavy rain and is more pronounced with higher frequencies.

If the degrade threshold shown in the table is exceeded, the ACM engine will coordinate a shift of the modulation level down to the next level shown. **No packets will be dropped during this transition** since the two ends of the link are coordinating with each other to ensure that the switch occurs at the same time. Since lower modulation levels are more robust against channel fading and multipath, they can tolerate a higher MSE as is evident from the table.

If the link conditions continue to degrade, the shifts downward will continue until the lowest modulation level, QPSK, has been reached. If further degradation occurs above the maximum MSE (shown previously in Table 5) for QPSK, the link will be dropped and packet loss will occur. If the link MSE starts to improve, however, the ACM engine will gradually shift the modulation level up as the improve thresholds are passed.

When ACM is active the modulation level may be asymmetrical, meaning that one direction may be running at QPSK and the other may be running at the originally set higher modulation such as 256 QAM. This is because the ACM engine acts independently at each endpoint of the link. A low level Binary Phase Shift Keying (BPSK) channel is maintained between the two ends to allow very tight coordination of the switches in modulation. Only data traffic capacity in the direction towards the affected receiver will be reduced as the modulation level is reduced, maintaining performance on the unaffected direction.

During all ACM operation the transmitter power remains at the set level if ATPC is off. If enabled, ATPC acts normally when ACM is active and may increase or decrease the transmit power based on RSSI levels and the ATPC maximum levels set for each modulation. This gives a significant advantage in the system gain since the maximum transmit power can be increased automatically as the modulation level is reduced. As the modulation level increases with improving channel conditions, the transmit power will be decreased. From the operator perspective all that is required is to set the maximum power levels for each modulation and enable ATPC.

The **acm** command provides configuration of the ACM and must be done on both sides of the link. The **linktest** command from the CLI can be used to view the current TX and RX modulation levels.



## Wireless Link Capacity

The table below shows the capacity of the system for each non-ACM speed setting. The capacities for the ACM settings will be approximately 1-2% lower due to the additional overhead of the ACM.

All capacities shown are in Mbps full duplex, meaning that the aggregate bidirectional capacity is twice the number shown.

The capacities shown are also layer 2 using 1518 byte packets for IPV4. Layer 1 numbers will be higher, especially for small packets:

BW(MHz)	QPSK	QAM16	QAM32	QAM64	QAM128	QAM256
3.5	6	9	15	18	21	23
5	8	12	19	24	27	31
7	10	20	25	31	36	40
8.33	13	26	33	40	46	52
10	15	30	37	46	53	60
12.5	20	40	49	60	70	78
13.75/ 14	22	45	55	67	78	88
20	31	63	78	96	111	126
25	39	80	99	120	140	160
28/30	47	95	118	142	167	192
40	63	128	159	192	225	256
50	78	157	195	238	277	318
55/56/80	90	181	225	275	320	365*

**\*375 Mbps when set to speed 80 qam256, with symbol rate 49.9 Msym/sec**

Table 6 Max Link Capacity (Mbps) for non-ACM Speed Settings

## Automatic Transmit Power Control (ATPC)

**ATPC** and **targetRSSI** work together to control the remote side power output in order to achieve optimal signal strength. ATPC can be enabled or disabled. When enabled, ATPC will adjust the power of the remote side based on the local targetRSSI setting.

If the current RSSI value is lower than the targetRSSI setting of the local radio, the local radio will send commands over the air instructing the remote radio unit to increase its output power to achieve the targetRSSI setting within +/- 2 dB.

If the RSSI value is higher than the targetRSSI setting, the remote radio will be commanded to reduce the power until either the target level is reached within +/- 2 dB or the TX power has hit the minimum level (See Table 8).

ATPC also works in conjunction with the ACM mechanism to increase transmit power with modulation levels changes. The **atpc max\_power** command allows setting the individual maximum power levels for each modulation level from QPSK to QAM256

ATPC has Step Size and Max Power settings to limit the output power of the unit and prevent a violation of the license.



The user set transmit power setting cannot be changed after ATPC is enabled. To manually change the power setting, ATPC needs to be disabled.

### ATPC Max Power & Step Size

Settings for **ATPC Max Power** and the **ATPC Step Size** control how the ATPC function will behave while attempting to achieve the **targetRSSI**. ATPC Max Power is the maximum power setting ATPC can set the power output to when trying to reach the TargetRSSI. ATPC Step Size is the power level change in dB that ATPC can change power output. Larger step sizes result in faster response to fading conditions.

### Transmitter Maximum Power Output

Maximum Transmitter power output is dependent on the band of operation and the modulation level. Both the AP1 and AP2 models have the same default maximum power levels for each band and modulation. AP1 models can be set to higher transmit power levels for some frequencies when the Power License Key (AP-KE-3) is enabled. See Table 7 for details.

There is no dependency on the channel bandwidth used within a particular band. As an example, the power level for QAM256 within the 6 GHz band is the same for 3.5 MHz channels as it is for 56 MHz channels. The table illustrates this and shows the maximum set power levels for each model family, band, and modulation level.

Modulation	Maximum Transmit Power by Frequency (dBm)					
	6, 7, 8	10	11	13,15	18-26	28-40
QPSK	30	26.5	28	26	25	23
16QAM	28	22.5	26	22/25*	22/23*	21
32QAM	28	22.5	26	22/25*	22/23*	21
64QAM	25	20.5	22/25*	21/24*	20/22*	17
128QAM	25	20.5	22/25*	21/24*	20/22*	17
256QAM	24	18.5	21/24*	20/23*	19/21*	16

\*With high power license key (AP-KEY-3) on AP1 models only

Table 7 Maximum Set Power Levels by Band and Modulation

When ATPC is active, the **atpc\_max power** should be set to the maximum power for the each modulation used if adaptive power changes are desired with ACM modulation changes.

If the power level to remain constant across ACM modulation changes, all **atpc\_max power** levels should be set to the max power of the highest modulation level, typically 256QAM.

If ATPC is off then the power will not be changed under any circumstance and will remain at the level set by the operator.

### Transmitter Minimum Power output

The minimum transmit power that can set is limited by the ODU model and is not dependent on the modulation level like the maximum levels are. The table below shows the minimum power levels for each band and model family. The levels are also the minimum levels that ATPC can set the output to when enabled.

ApexPlus Model	Transmitter Minimum Power Output Level (dBm)												
	6 GHz	7 GHz	8 GHz	10 GHz	11 GHz	13 GHz	15 GHz	18 GHz	23 GHz	26 GHz	28 GHz	32 GHz	38 GHz
AP1-XX-YYY-ZZ	+9	+9	+9	NA	+6	+3	+3	+2	+2	+2	+2	+1	+1
AP2-XX-YYY-ZZ	+0	+0	+0	+0	+0	+0	+0	+0	+0	+0	+0	+0	+0

Table 8 Minimum TX set power by band

## Receiver Maximum Input

The maximum receiver RF level, measured by RSSI, is depicted in Table 9 below. If the RSSI value is higher than listed for the modulation being used, packet loss may result. When operating short range links with a high receiver input level, always make sure that the transmitter power is adjusted down from the maximum to ensure the levels shown below are not exceeded, or active ATPC with a *targetrssi* that is at least several dB below the levels shown to provide a safety margin.

Modulation Level	Max RSSI
256 QAM	-24 dBm
128 QAM	-22 dBm
64QAM	-20 dBm
32QAM	-18 dBm
16QAM	-16 dBm
QPSK	-14 dBm

Table 9 Max Receive Level Input

### 3.0 Network Operation Detail

This section describes key network related elements of the system in detail.

#### 1+0 Non-Protected Link Configuration

The diagram below shows the typical setup of the ApexPlus in a network environment. Although this configuration is call non-protected, it is commonly used in ring architectures which use layer 2 or 3 routing to reroute the traffic the other direction if the link fails.

Figure 8 shows the unprotected 1+0 link setup with switches or routers.

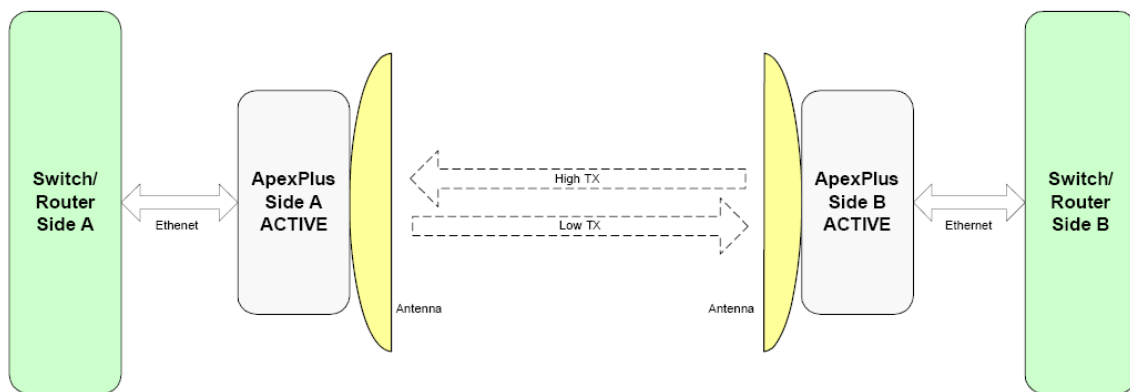

Figure 8 1+0 Setup



The Table below shows the events will cause a failover from active to standby:

Event	Failover Type (local Site)	Failover Type (remote pair)
Modem link lost on Active	Hardware	Hardware
CLI “utype_switch”	Software	Hardware
Power supply failure on Active	Software	Hardware
Reboot on Active	Software	Hardware
ODU PLL failure on Active	Software	Hardware
Violation of threshold setting	Software	Hardware
Link related command (see list)	No failover	Hardware
Power supply failure on Standby	No failover	No failover
Reboot on Standby	No failover	No failover
Odupower on/off on Standby	No failover	No failover
ODU PLL failure on Standby	No failover	No failover
Modem link lost on Standby	No failover	No failover
1+1 cable removal/failure	No failover	No failover
ACM Tx/Rx profile changes	No failover	No failover

Table 10 Failover Events

### Hardware triggered failover

In the event that the modem RX link is lost (status changes from “1” to “0”), a hardware triggered failover will occur and the following sequence of actions will occur:

#### Actions:

- 1) The IF transmit signal will be shut off on the active unit and enabled on the backup unit
- 2) The standby ApexPlus utype will change from standby to active and the previously active unit utype will change to standby.
- 3) The Ethernet port will be shut down on the new standby unit if RPS was enabled.

- 4) The far end of the link will also failover since the transmitter switch will cause the far end to lose lock as well. Steps 1-3 above will repeat for the far end.

Hardware initiated failover to the backup pair will occur on the far end unit due to the small gap in the transmitter being switched from active to standby on the local side. The total time for the failover to occur is typically 150-200 milliseconds.

A hardware failover will only occur the following initial conditions are met, otherwise none of the events in the Table will cause a failover.

- 1) A Standby unit is detected
- 2) The active Radio has its RX locked.
- 3) The election time period is over.
- 4) The guard time has elapsed

### **Software triggered failover**

Software triggered failover is Initiated by the software based on the following conditions. Software failovers will take 3- 5 seconds due to the fact that the events are polled by the operating software inside the unit.

- 1) ODU PLL unlocked
- 2) Violation of a threshold setting when failover is configured as one of the threshold actions.
- 3) Power Supply failure

### **User triggered (manual) failover**

Initiated by user issue CLI/SNMP/web commands as shown below. Typically the only user triggered command that should be executed is the ***utype\_switch*** command, which is used when the original active unit is restored or replaced and the operator wants to return it to active status. The other commands are listed to make the operator aware that they will cause an unintentional (and usually undesired) failover.

Commands that will force a failover

1. Using the ***utype\_switch*** command to restore the active after a failover
  - a. This command can only be initiated on the Active unit.
  - b. A low level command is sent from Active to Standby unit to turn on transmitter.



2. User commands: When the operator changes the following settings on the active unit, an unintentional failover may occur. It is not recommended to run any of these commands while an active 1+1 link is running:
  - a. *acm enable*
  - b. *bootimage upgrade odu*
  - c. *datapath*
  - d. *data pattern*
  - e. *loopback*
  - f. *opmode*
  - g. *odupower*
  - h. *power*
  - i. *reboot*
  - j. *speed*

## Rapid Port Shutdown (RPS)

ApexPlus supports the shutdown of the Ethernet ports to assist in rerouting traffic in the event of a link failure. When enabled at both ends of the link, All Ethernet ports at both ends of the link will be shut down within 50 mS of the modem lock status changing from “1” to “0” at **either** end of the link.

RPS emulates a cable failure if the entire link is thought of as a cable, and will trigger a routing change when used with a switch or router setup for Rapid Spanning Tree Protocol (RSTP) or another layer 2 routing protocol at both ends, as is normal in a ring architecture. For higher layer routing protocols the ports are normally left active in the event of a link loss.

**It is highly recommended that the operator enable ACM when using RPS since the fade margin will be much higher than a non-ACM speed setting, preventing link loss and subsequent rerouting during weather related events.**

## VLAN Tagging

ApexPlus supports tagged packets with VLAN IDs ranging from 0-4089. The last seven VLAN IDs are used internally as described in the Port Mapping Section below. If In-Band Management (IBM) is used and the OMU model is AP-OMU-1, the management traffic must have a VLAN tag to allow the switch internal to the system to identify packets in the data stream and direct them to the CPU for processing. The VLAN ID for management is user specified using the *ibm* command, with a factory default VLAN ID of 4085. For AP-OMU-2 models, IBM without a VLAN is allowed in addition to IBM with VLAN.

Q in Q Support : ApexPlus supports double tagged packets on all ports using Ethertype 9100 and 88A8, but no QoS will be performed on these packets. If Service Provider

Tagging and reprioritization is desired, Ethertype 8100 should be used by the provider in the outer tag on customer traffic. In other words, the service provider can override the priority field in any packet by adding another VLAN tag with a new priority to the packet using a switch just before the Radio input. The ApexPlus will apply QoS to the outer tag as long as the Ethertype is 8100.

### **Port Mapping (802.1q)**

The port mapping feature is a fixed setting and provides an additional amount of data security since traffic on the Ethernet port is segmented and isolated from traffic on the fiber port. Port mapping is implemented by using VLAN tags internal to the ApexPlus link. When Ethernet Traffic arrives in a port, it may be tagged or untagged. Both tagged and untagged packets are tagged with an additional internal VLAN Tag depending on which port they arrived at as follows:

**GE1: GigE 10/100/1000BaseT port** :VLAN ID 4091

**GE2: SFP port:** VLAN ID 4092

At the other end of the link, the internal tags are removed and the original packets are sent out unaltered. Essentially the ApexPlus is performing double tagging on packets that have already been tagged.

### **Quality of Service (QoS) (802.1p and Diffserv)**

ApexPlus internal switch fabric performs QoS on all incoming packets to allow the operator to give priority to certain traffic types. The following fields are used to classify the incoming traffic:

- Layer 2 using the COS bits in the VLAN tag on incoming Ethernet traffic (Tagged traffic only)
- Layer 3 Diffserv (DSCP) using the Differentiated services field in IP packets. The DSCP mapping can be controlled on a port by port basis from CLI or Web.
- Port Priority for untagged traffic

The incoming traffic is mapped into 4 queues (FIFOs) which are emptied into a single data pipe going into the modem and subsequently over the air. The scheduling of the queue traffic into the modem data pipe can be either strict or Weighted Round Robin (WRR)

Strict QoS Mode, which applies to the VLAN COS field only, follows the logic rule below:

**COSQ3> COSQ2> COSQ1 > COSQ0**

This rule essentially means that the system will empty COSQ3 before sending any COSQ4 packets across the link, and if both COSQ3 and COSQ2 are empty then COSQ1 packets will be sent, etc. Note that while strict priority ensures that **ALL** high priority traffic will go through (up to max burst size and link capacity limits), it may block lower priority traffic or increase the latency significantly for lower priority packets during traffic congestion.

The default priority mapping of the packet will be set as follows:

COS priority 0 → **COSQ0**, Lowest Priority Queue  
COS priority 1 → **COSQ1**  
COS priority 2 → **COSQ2**  
COS priority 3 → **COSQ3**, Highest Priority Queue

These default mappings can be changed with the **qos** command, allowing the packets to be mapped into any one of the 4 queues based on the COS bit in the VLAN tag. Different priority tags may be mapped into the same queue if desired.

In WRR QoS Mode, both COS and DSCP bits are used. The DSCP field in the IP packet will contain a number from 0-63 in the Type of Service (TOS) field, which can be mapped to a priority level, which is subsequently mapped to a queue.

WRR mode allows weights to be applied to each queue to allow the QoS engine to spend at least some portion of time emptying the queues. This mode is useful for allowing at least some of the lower priority traffic to get through the link and ensuring that **MOST** high priority traffic will go through. Both COS and DSCP fields are monitored on the incoming traffic for assignment of packets to the queues.

The traffic can be classified into 8 priorities (0-7 based on the VLAN tag COS/DSCP bits). This is done external to the GigaPlus unit using a switch or application to set the priority tag field or by the application. Once the tagged traffic with COS/DSCP priority bits set arrives in the GigaPlus Ethernet port, the internal switch will perform prioritization on the traffic by mapping it to one of 4 queues.

## Port Priority

The port priority feature allows for untagged traffic arriving into each Ethernet port to have priority level assigned to it. If the arriving traffic is already tagged then that tag priority level will be honored over the port priority. The port priority setting will determine which port traffic is forwarded in the event of more traffic coming into all the ports than the capacity of the system can handle.

Port priority can augment port rate limiting, especially in when ACM is active and the link has downshifted to a lower modulation. The **port** command is used to set the port priority for each port.

## Port Rate Limiting (Ingress)

The port rate limiting feature is used to restrict the ingress traffic rate on a specific Ethernet port. This is useful for Service Level Agreements (SLAs) when both ports of the GigaPlus are being used to supply two customers and the channel capacity is limited to less than the sum of the capacity of the two Ethernet ports.

For example, if both ports are set to 1000BaseT, and the RF channel capacity is 375 Mbps, setting GE1 to rate limit of 125 Mbps and GE2 to a rate limit of 250 Mbps will always guarantee that both users have the bandwidth of the channel reserved for them.

Packets are dropped before QoS processing, so if QoS is desired the port rate should be set to match the line rate (default).

## Egress Margin

Egress margin is used to fine tune the behavior QoS when using VLAN tagged traffic marked with COS priority (802.1p), or when using port priority to assign priority to untagged traffic on multiple ports.

Traffic coming into the Ethernet ports is bursty by nature and may exceed the radio link capacity if the radio speed is less than the Ethernet line speed (10/100/1000 Mbps). To reduce or eliminate traffic loss in this case, buffers are used inside the OMU. These are the same buffers used for QoS traffic grooming.

The traffic from all Ethernet ports share the buffers and are serially fed to the radio section at a rate equal to or slightly less than the radio capacity. The egress margin simply controls the egress rate in Mbps from the switch as a percentage added or subtracted for the nominal link capacity. The default is 0% which means that the rate from the switch into the modem section will be equal to the total link capacity. This setting will provide the best throughput for all packet sizes, but may allow some high priority packets to be dropped when the channel is overloaded (input rate > link capacity).

By setting the egress margin to between -2 and -15 percent, the QoS will be enforced and no high priority packets will be dropped.

## 4.0 Link Management

This section describes the various ways to manage and monitor the health and performance of the ApexPlus microwave backhaul link.

### Overview

The ApexPlus can be managed through the following methods:

#### Graphical User Interface (GUI):

**Web Browser:** Remote access via in band and out of band methods with two level view and configuration level access using any standard web browser such as Internet Explorer, Chrome, Firefox, and Safari .

#### Command Line Interfaces

**SSH** – Encrypted remote access via in band and out of band methods with separate view and configuration level access (password protected)

**Telnet** – Remote access via in band and out of band methods with separate view and configuration level access (password protected)

**Console** – Local Access using a serial cable for bench configuration with separate view and configuration level access (password protected).

**SNMP** – Remote control and monitoring via in-band and out-of band methods using any third party Network Management Software (NMS). See Appendix D for details on the MIB and SNMP objects. Standard MIB II System Level and Enterprise MIB Blocks are supported with monitoring for all major link health and traffic related metrics.

#### Default IP Address

The factory configuration for IP address is 192.168.100.100 for all units, and the IBM default address is 172.16.1.1 for the "A" side unit and 172.16.1.2 for the "B" side unit.

#### Default Passwords

The default passwords are shown in the table below:

Access mode	Username	Password
CLI View Mode	admin	trango
CLI Config Mode	N/A	trango
CLI Debug Mode	N/A	N/A
Web View Mode	admin	trango
Web Config Mode	config	trango
SNMP Read Community	N/A	public
SNMP Write Community	N/A	private
SNMP Trap	N/A	trapstr

Table 11 Default Login Passwords

## Graphical User Interface (Web Browser)

To access the browser interface simply open your Web browser and enter the IP address of the radio. A login window will pop up, requiring a user name and password (Figure 10). Enter the default (user= “admin”, pw = “trango”) or modified user name and password then press OK to bring up the View mode Browser interface.

Figure 10 Web Browser Login

In View Mode, no changes can be made to system operating parameters, but statistics and current settings can be viewed. If changes are required, the user can log in to the Config Mode by selecting the Config Login button at bottom left. The default username is “config” and the default password is “trango”.

The first page to display will be the System Info Page as shown in the Image below:

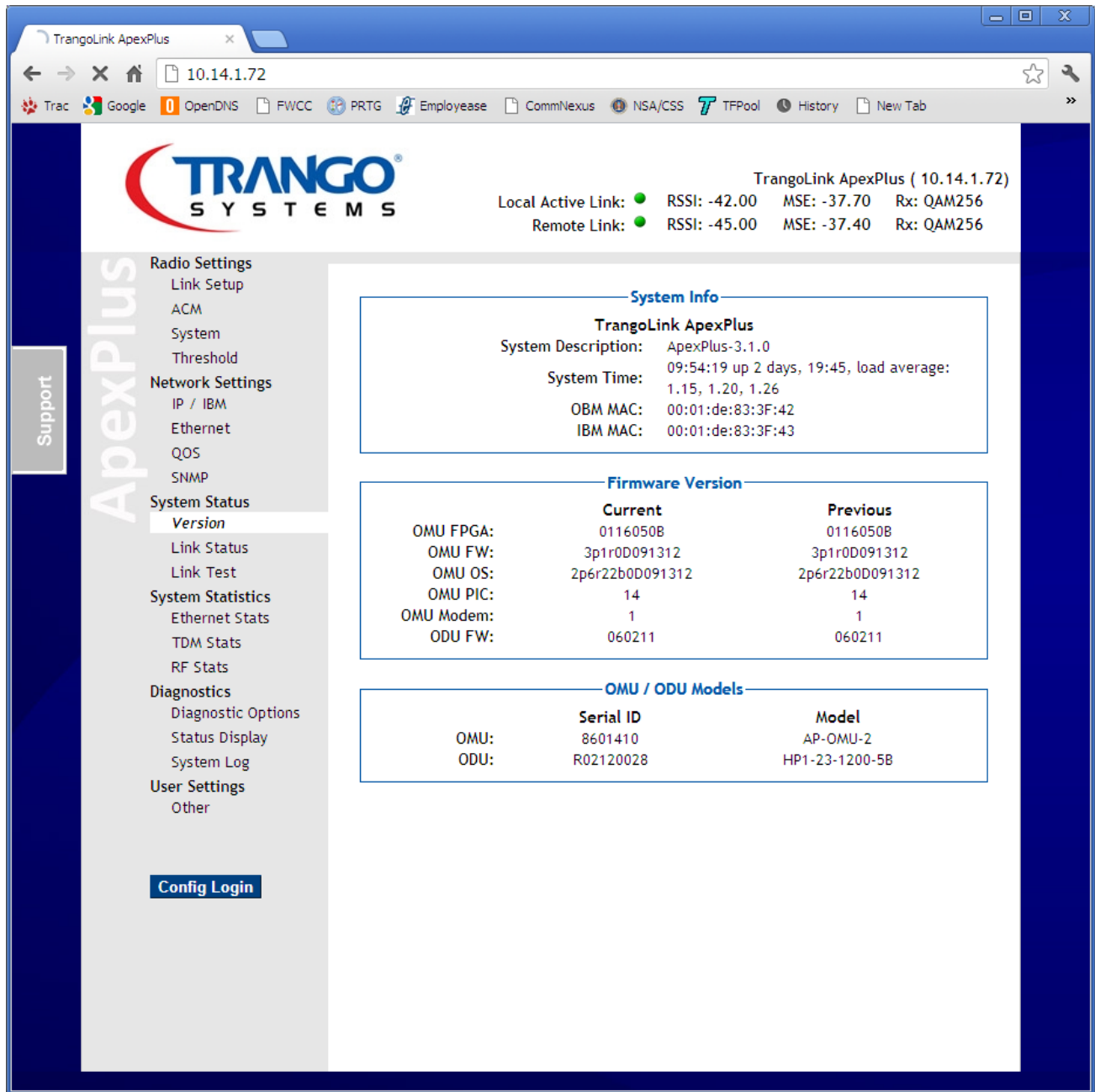

Figure 11 System Info Page

The main format of the ApexPlus Web Interface is shown in Figure 11 above. The layout is designed to allow the operator to view the current link status on all pages. The left side of the display shows various pages organized by function. Each page can be opened and explored by simply clicking on the italicized page name. Below is a description of each function.

**Navigation Bar:** The navigation bar the left shaded area containing the functional categories. The navigation bar contains the following categories:

- **Radio Setting:** The essential Radio Link setup parameters, TX/RX frequency, transmitter power, ATPC, speed and modulation, as well as the capacity license are found here. Settings for 1+1 failover are found here as well.
- **Network Settings:** The essential Network setup parameters, such as IP address, In Band Management (IBM), Ethernet port settings, Quality of Service(QoS) and SNMP setup are located here.
- **System Status:** Shows most of the basic configuration parameters of the radio, including firmware versions, OMU/ODU models and serial numbers, and Management port MAC addresses. All port and radio link status are shown here as well. The link test command can be run here to view the current RF link state
- **System Statistics:** Counter/status information on all interfaces RF, Ethernet, and T1/E1 ports is displayed. These statistics are refreshed automatically and can be cleared from the web page.
- **Diagnostics:** This section contains pages that show current system settings, the system log which records all the events and user settings, and a special diagnostic export function that produces a text file for Trango Tech Support to use when troubleshooting is required. This folder also has a page to control the loopback functions, view the syslog, and run other special diagnostic functions.
- **User Setting:** User can change the web view and config passwords, change the system remark field and change the web refresh rate.



## Command Line Interface (CLI) using SSH, Telnet or Console

All typical radio functions can be managed via the browser interface, but the Command Line Interface (CLI) has additional functionality that facilitates installation and troubleshooting.

The Command Line Interface has 3 nodes: View, Config, and Debug. Logging into the radio via Command Line Interface is covered here briefly, and a complete listing of all CLI commands is provided in Appendix A

Logging into the radio via Command Line Interface is covered here briefly. A complete listing of all CLI commands is provided in Appendix A - Command Line Interface.

### Launch Telnet

Open a command prompt (DOS) session on your PC (Windows® Start icon and select “Run”). Open a Telnet session by typing:

```
telnet [ip address of radio]
```

#### **Example:**

```
C:>telnet 192.168.100.100
```

Once at the CLI login prompt, type in the login and press enter, then the password and press enter.

```
CLI login: admin
Password: (No characters will be display during input)

Trango System: TrangoLINK ApexPlus Command Line Interface
v1.0.0

(CLI-view) #
```

If the incorrect password is entered during login, the system will allow two more tries before terminating a telnet session. A new session will need to be open to try again.

To terminate a CLI session (Telnet or Console) simply close the console window. A CLI SESSION CAN ALSO BE TERMINATED FROM THE **DEBUG NODE** WITH “EXIT” COMMAND.

View Node : *(CLI-view) #* prompt allows view level only, and no parameters of the radio link can be changed.

Config Node: (CLI-config) #, This node is accessed by typing in the command **config** from the view node. The system will prompt for a password and after successful authentication, the config node is enabled. All configuration settings are changed within the config node.

Any command entered without any parameters returns the current configured values similar to “view” node.

Most configuration changes are applied immediately and do not require a reboot. All config changes must be saved to FLASH memory by issuing the **config save** command. This can be done after all the changes desired are made within a single session

If the configuration is not saved, the system will restore the last saved settings after reboot.



ALL CONFIGURATION CHANGES HAVE TO BE SAVED TO FLASH IN ORDER TO BE PERSISTENT ACROSS A REBOOT. A SINGLE “CONFIG SAVE” COMMAND WILL SAVE ALL CONFIGURATION CHANGES

The operator can go back to the “view” node by using the **exit** command from the config node.

**Example:**

```
CLI login: admin
```

```
Password:
```

```
Trango System: TrangoLINK ApexPLUS Command Line Interface  
v1.0.0
```

```
(CLI-view)# config
```

```
Password:
```

```
(CLI-config)#
```

```
(CLI-config)#exit
```

```
SUCCESS
```

```
(CLI-view)#
```

The Command Line Interfaces keeps a history of commands used, pressing the up arrow will display previous commands used. The CLI can supports auto-complete of a command being typed by pressing <tab> key. If a command is partially typed followed immediately by a “?” it will display all related commands.

**Example:**

```
(CLI-config)# ? (The ? will not be display)
targetrssi Set target RSSI level for ATPC
tdm        Display TDM configuration
telnetd    Enable/Disable telnetd
temp       Display IDU and ODU temperature
tftpd      Enable/Disable tftpd
threshold  Set the threshold for the radio parameters
trap       Display snmp trap management information
(CLI-config)#
```



TYPE “?” FOR A LISTING OF ALL CLI COMMANDS.

**Changing Password**

The debug and view node share the same password. The config node has a separate password. The view and debug mode password is changed in the debug mode. The config node password is changed in the config node. Use the CLI command **password** to change the password. The example below demonstrates changing the password for the config node to “control”

Syntax: *password* <newpassword> <newpassword>

**Example:**

```
(CLI-config)# passwrd control control (The password must be entered twice)
```

If the command is properly executed, the system will return a “SUCCESS” and return to the **CLI-config** prompt.

If the password is lost and the unit is locked, the pushbutton on the access panel can be used to reset the password and default IP back to the factory settings

## Console Port

ApexPlus features a console port which is multiplexed with the port for the 1+1 hot standby operation. If 1+1 hot standby is active the console cable cannot be used. The console port is useful in the event that the unit cannot be accessed via TCP/IP (HTTP or Telnet). A Terminal Emulation program such as **HyperTerminal** or **Putty** can be used to access the radio's CLI via the console port as shown in Figure 12.

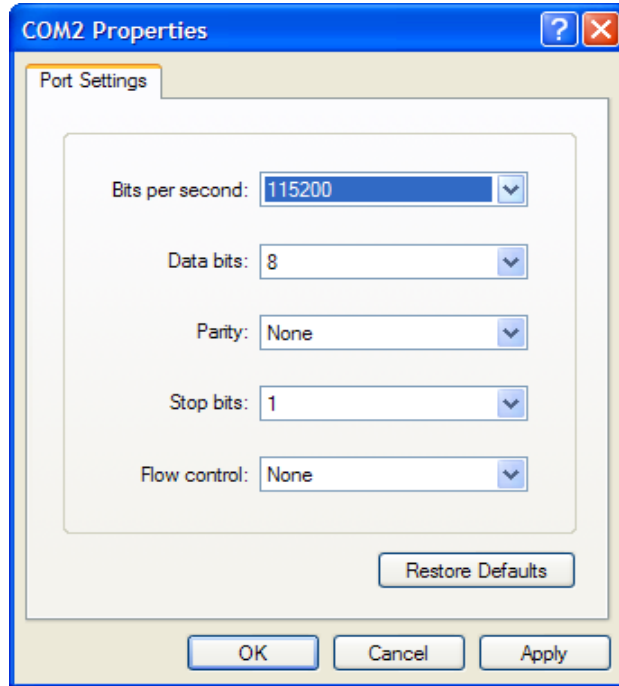

Figure 12 Console Port Setting

## Simple Network Management Protocol (SNMP)

TrangoLINK® ApexPlus supports Simple Network Management Protocol (SNMP) for network management. Network management consists of 4 categories:

1. Configuration
2. Accounting
3. Alarm
4. Monitoring/Control

These capabilities allow the network operator to provide superior services through higher network accessibility and integrated accounting system. Use of SNMP requires the customer to have already implemented a NMS or SNMP software package.

The Trango SNMP solution supports MIB-II (system only) and the Trango proprietary Management Information Base (MIB).

Users interested in using the SNMP functionality should review the entire TrangoLINK® ApexPlus MIB, found in Appendix D, for a complete understanding of its features.

The following is an overview of some of the more commonly used SNMP objects in the TrangoLINK® ApexPlus system. A complete listing can be found in Appendix D.

A copy of the MIB files for the current firmware version can be obtained by contacting Trango Technical Support.

## **Common Objects for Monitoring and Control**

### ***GigE Bandwidth Monitoring***

- **gigeEth1InOctets**: Number of octets of payload received on GigE port 1 (copper).
- **gigeEth2InOctets**: Number of octets of payload received on GigE port 2 (fiber).
- **gigeEth1OutOctets**: Number of octets of payload transmitted on GigE port 1 (copper).
- **gigeEth2OutOctets**: Number of octets of payload transmitted on GigE port 2 (fiber).

### ***RF Monitoring***

- **rfInOctet**: Number of octets of payload received on the RF port.
- **rfOutOctet**: Number of octets of payload transmitted on the RF port.
- **rfEthernetInPackets**: Number of octets of payload received from the GigE ports to transmit on RF port.
- **rfEthernetOutPackets**: Number of octets of payload transmitted to GigE ports from RF port.
- **rfRSSI**: The Receive Signal Sensitivity Indicator the unit receives from the distance end of the link.

### ***Link Status Traps***

Various traps are defined as follows:

- **trapReboot**: trap is triggered when the unit is rebooted.
- **trapStartUp**: trap is triggered when the unit boots up.
- **trapBackupLink**: trap triggered when the backup status changes.
- **trapBackupTakeover**: The trap is triggered when the Backup unit has taken over.

- **trapModemLock** - This trap will inform you when there is a change to the link lock.
- **trapDownShift** - This trap will inform you when the modulation of the radio has shifted downed.

Trango recommends monitoring RSSI, MSE, Ethernet Traffic (gigeEthOctets), Temp, and modem lock as a minimum for thorough monitoring of the link. Additional objects and traps can be added to the monitoring software as required. Please review Appendix D MIB for a complete listing of MIB Objects and Traps.

Understanding and familiarization of Simple Network Management Protocol (SNMP) concepts and software platforms are required to utilize SNMP management of the TrangoLINK® ApexPlus system.

Due to the large number of programs available for SNMP, Trango does not provide support of SNMP software packages or NMS systems. Some common items to try while having issues monitoring specific OIDs are:

- Properly load the MIBs into your software
- Try adding a “.0 “ at the end of your OID string

## Firmware Upgrade

The firmware on the TrangoLINK ApexPLUS can updated to a newer version through IBM or OBM Ethernet Ports. A firmware release consists of up to two files which contains the appropriate software files that are loaded onto the OMU and ODU:

OMU OS Image Firmware File      < omu.apexplus\_<version>.tar.gz>

ODU Image Firmware File      <odu\_fw.bin>

If only the OMU firmware was changed then the ODU firmware does not need to be updated.

Before beginning the update procedure, be certain that all required files have been downloaded to an easily accessible directory on your local hard drive.

## Upgrade Procedure -TFTP



ALWAYS CONSULT THE UPGRADE INSTRUCTIONS THAT ARE INCLUDED WITH A NEW FIRMWARE RELEASE AS CERTAIN FILES MAY NOT BE REQUIRED FOR AN UPGRADE.

- 1) Place the firmware files in an easily accessible directory path on your computer.
- 2) Telnet into the radio by Clicking on Start menu then RUN. The figures use the default IP address; you must use the correct IP address for the TrangoLINK ApexPlus.

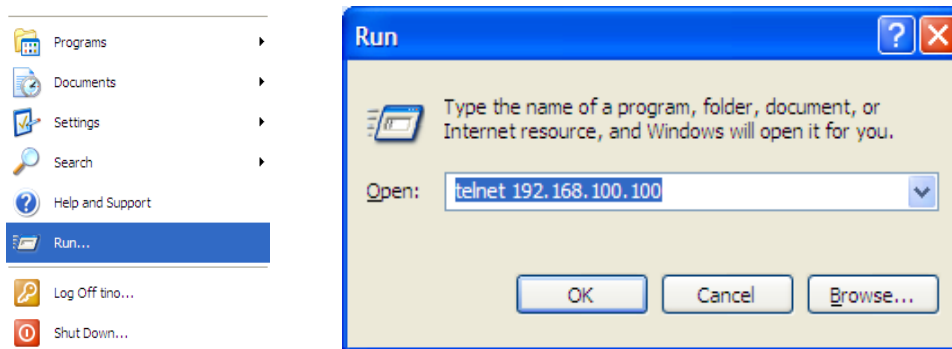

Figure 13: Windows Start & Telnet

- 3) At the login enter your username and password. The username is “*admin*” and default password is “*trango*”
- 4) Enter ***config*** node by typing “*config*” and entering you write access password. The default config node password is “*trango*”
- 5) Enable the tftp daemon using the TFTP command as shown below.

Login as: admin

Password:

Trango System: TrangoLink ApexPLUS Command Line Interface v1.0

```
(CLI-view)# config
Password:
(CLI-config)#
```

```
(CLI-config)# tftpd on
tftpd: on
SUCCESS
(CLI-config)#
```

- 6) Open a MS-DOS prompt (or other CLI interface) window and access the directory that you extracted the firmware files.

```
C:\CD Firmware
C:\Firmware
```

- 7) Using windows TFTP command line tool, we will upload the firmware file. The tftp syntax and an example are below.

```
TFTP [-i] host [GET | PUT] source [destination]
```

```
C:\firmware>tftp -i 192.168.100.100 put omu_apexplus_v10.tar.gz
Transfer successful: 1951744 bytes in 15 seconds, 130116 bytes/s
```

- 8) Once the file has been transferred successfully, log back into the unit and apply the updates into the FLASH memory using the **bootimage** command from the config mode. Each firmware needs to be upgraded on the unit using the **bootimage upgrade** command.

```
(CLI-config)#
(CLI-config)# bootimage upgrade omu
```

**NOTE: THE BOOTIMAGE UPGRADE COMMAND MUST BE ALLOWED TO COMPLETE BEFORE THE SYSTEM IS REBOOTED. IF THE SYSTEM IS REBOOTED DURING THE WRITING OF THE IMAGE TO FLASH, THE FLASH MAY BECOME CORRUPT – WAIT FOR THE SUCCESS INDICATION BEFORE PROCEEDING.**



If the ODU firmware was also being upgraded, the ODU file would be transferred to the ApexPlus using the same method as the OMU file. After loading the file, the **bootimage upgrade odu** command would be used to write it to FLASH.

```
(CLI-config)# bootimage upgrade odu
```

- 9) A reboot of the radio is required to load the new image after upgrade

```
(CLI-config)# reboot
```

The upgrade time varies depending upon the images and the size of the image.

The firmware can be verified by logging into the radio via the CLI through the **version** command or Web browser version page under the Firmware Version section.

The Current firmware is the currently running firmware. The firmware which was replaced will be located in the Pprevious images.

### Upgrade Procedure -FTP

To perform the firmware upgrade using FTP, use the **ftp** command to load the images into memory, then the **bootimage upgrade** commands just as with the TFTP method. The FTP method is much faster and has built in error checking.

All that is needed is the IP address of the ftp server, a username/password, and the filename to be uploaded. The new file to be uploaded should be placed on the server. The ftp server will prompt for the password before allowing access.

- 1) Put the new software files on the ftp server using the ftp put command from a local computer (these commands are not done from the Trango equipment).

```
ftp> put <source file> <destination>:
```

The <source> will be the filename only. The <destination> will include both path and file name.

- 2) After putting the file onto the server, log into the ApexPlus and run the **ftp** command from the command line as follows to open access to the server:

```
ftp <server_ip> <user_name>
```

```
password: xxxxxxx
```

If prompted for the password multiple times, check the connectivity to the server by pinging the FTP server IP address from the debug prompt.

- 3) Next , get the file from the FTP server by typing the get command from the ftp prompt.

```
ftp> get <file_name>
```

- 4) Logout of the ftp session

```
ftp> logout: logout of ftp session.
```

- 5) Run the **bootimage** omu and/or **bootimage** odu command as required.

## Capacity/Transmit Power Upgrades

The ApexPlus speed capacity is standard at 100 Mbps. To upgrade the capacity or Transmit power for AP1 models, an alphanumeric key will be required. This key can be purchased from your Trango sales representative.

To update the capacity/power key from the Web, copy and paste the applicable key into the Speed or Power License field on the Link Setup Page. Click the submit button. If the license is accepted, the word “Enable” will be displayed as shown below and replace the blank field.

TrangoLink ApexPlus ( 10.14.1.72)  
Local Active Link: ● RSSI: -42.50 MSE: -37.60 Rx: QAM256  
Remote Link: ● RSSI: -45.50 MSE: -37.50 Rx: QAM256

**System Configuration and Licenses**

Datapath:    
Speed License: Speed License 2 enabled   
Power License: Enable   
Failover Mode:  ON (port on)  ON (port off)  OFF   
**Submit**

Note: Enable license key does not require reboot

**ODU Power**

ODU Power: ON   
**Odupower On** **Odupower Off**

**Link Setup:**

Default Opmode:  ON  OFF   
Tx Freq Min: 22400.00 Tx Freq Max: 22800.00   
Tx Freq: 22800.00 Rx Freq: 21600.00   
Freq Duplex: 1200.00   
Bandwidth:  Set Modulation:    
Power: 15.00   
**Link Setup**

Note: (\*) denotes custom profile is in use

**Operation Mode**

Opmode: ON   
**Opmode On** **Opmode Off**

Figure 14 Capacity Upgrade – Web

The capacity key can also be entered using the *license* command from the command line interface.

## **5.0 Link Planning**

This section describes the process that occurs before installing and setting up an ApexPlus microwave backhaul link

### **Frequency/Path Planning**

Most microwave links use licensed spectrum that requires third party coordination to ensure minimal interference will occur to nearby licensed spectrum users. To ensure success, a path analysis must be done for each link that is being considered. Antenna heights, system gain, rain region and terrain data are evaluated to determine the reliability of the link over time and changing weather.

Trango will run path analysis for its customers using industry standard software, evaluate different equipment options to achieve the customer goals, and assist the coordination process.

### **Site Selection**

After the Planning phase is complete, it is essential that the proposed site be physically evaluated by the operator to ensure that no buildings or vegetation has crossed into the Fresnel zone that would affect operational reliability.

It is not uncommon for tall buildings to be located in what would otherwise be a perfect non blocked line of sight path based on terrain data, but too often this is discovered when the installation is being performed.

The site must also be evaluated for power and shelter provisions.

### **Licensing**

Licensing of spectrum is typically done on an individual path basis. In the US, the FCC will grant licenses for 11 years for paths that do not interfere with other users after the coordination and fees have been paid.

Contact Trango for more information on the above topics.

## 6.0 Installation

This section describes the installation to ensure that the ApexPlus units are correctly installed. Failure to follow these procedures may result in damage to the equipment and void the factory warranty.

### Safety

Installing microwave equipment can be dangerous. Please take the following precautions when installing or performing maintenance on the equipment.

**Equipment Protrusions:** The equipment has been designed to be free of unnecessary protrusions or sharp surfaces that may catch or otherwise cause injury during handling. However, always take care when working on or around the equipment.

**Laser and Fiber Optic Cable Hazards:** Trango fiber optic SFP Module transmitters are IEC60825-1 / 21CFR1040-1 Class I compliant and present no danger to personnel in normal use. However: Do not look into active unterminated optical ports or fibers. If visual inspection is required ensure the equipment is turned off or, if a fiber cable, disconnect the far end. Follow the manufacturer's instructions when using an optical test set. Incorrect calibration or control settings could result in hazardous levels of radiation. Protect/cover unconnected optical fiber connectors with dust caps. Place all optical fiber cuttings in a suitable container for safe disposal. Bare fibers and fiber scraps can easily penetrate the skin and eyes.

**Lifting Equipment:** Be careful when hoisting or lifting the ODU or its antenna during installation or maintenance. The ApexPlus unit is nominally 15 lbs. However, antennas with their mounting hardware can weigh in excess of 100 kg (220 lb) and require specialized lifting equipment and an operator trained and certified in its use.

**Protection from RF Burns – Trango ODUs:** Trango ApexPlus ODUs do not generate RF fields intense enough to cause RF burns, however, installers/operators should comply with the following cautions:

- 1) It is hazardous to look into or stand in front of an active antenna aperture. Do not stand in front of or look into an antenna without first ensuring the associated transmitter or transmitters are switched off.
- 2) Do not look into the waveguide port of an ODU when the radio is active.

**Protection from RF Burns - Tower Site:** When the ApexPlus ODU is to be installed where existing antennas are located, avoid exposure to potentially harmful levels of RF radiation from these antennas by:

- 1) Determining the RF exposure risk. If necessary ask the structure/tower owner or operator. When necessary, wear a protective suit or have the transmitter(s) switched off for the duration of the installation.

2) Do not stand in front of or look into any antennas.

**Safety Warnings:** When a practice or procedure poses implied or potential harm to the user or to the radio equipment, a warning is included in this manual.

**Airflow Requirements:** Installations must be made so the airflow required for safe and correct operation of Trango equipment is not compromised. For the ApexPlus, unobstructed air passage must be maintained to all sides of the unit, and the gap between the OMU and ODU must not be blocked.

**Circuit Overloading:** When connecting the ApexPlus, determine the effect this will have on the power supply, circuit protection devices, and supply wiring. Check ApexPlus power consumption specifications and the supply capability of the power supply system. This check of capacity must extend to the dc power supply and not just to an intermediate connection point.

**Power Supply Earthing:** -48 V power supply earth must be connected directly to a bonding jumper from an earthing terminal bar or bus.

**Electrostatic Discharge (ESD):** ESD can damage electronic components. Even if components remain functional, ESD can cause latent damage and/or premature failure. Always wear proper ESD grounding straps when handling or touching any PCB assemblies. Connect your ESD grounding strap to the ground connector on the ODU or PoE units as applicable

**Fiber Optic Cables:** Handle optical fibers with care. Keep them in a safe and secure location during installation. Do not attempt to bend them beyond their minimum bend radius. Protect/cover unconnected optical fiber connectors with dust caps.

**Ground Connections:** Reliable grounding of the system must be maintained. Refer to instructions in this manual for grounding of the ODU, ODU cable, lightning surge suppressor, and IDU.

**Lightning Surge Suppressor:** ApexPlus Ethernet cables must be fitted with surge suppressors to prevent damage to equipment. Contact Trango for further details.

**Mains Power Supply Routing:** ApexPlus DC power, T1/E1, Ethernet data and management cables are not to be routed with any AC mains power lines. They are also to be kept away from any power lines which cross them.

**Ambient Temperature:** The ambient temperature range for the ApexPlus is -40° to +65° Celsius. To ensure operation and to maximize long term component reliability, ambient

temperatures must not be exceeded. Operational specification compliance is not guaranteed for temperatures outside this range.

**Mechanical Loading:** When installing the ApexPlus unit and antenna/remote mount on a tower mount or building, ensure the mount is securely anchored first and can support the full load of the radio unit and antenna. Ensure that the additional loading of an ApexPlus unit will not cause any reduction in the mechanical stability of the mount.

**Power Supply Connection:** The ApexPlus radio has the positive pin on its dc power supply connector connected directly to the chassis, which is in turn connected directly to the earth ground through the tower leg. ApexPlus radios must be used with a -48 Vdc power supply which has a positive earth; the power supply earth conductor is the positive supply to the radio or PoE injector.

- 1) There must be no switching or disconnecting devices in this earth conductor between the dc power supply and the point of connection to an ApexPlus system.
- 2) The power supply must be located in the same premises as the ApexPlus system.
- 3) All Ethernet cabling which is carrying power to the ApexPlus radio unit from the PoE injector must be 24 AWG solid strand Cat 5e or Cat 6 Shielded Twisted Pair (STP) cable with all 8 conductors terminated using shielded connectors. A low impedance connection must be made between the cable shield and connector ground shield.

**Power Supply Disconnect:** An appropriate power supply disconnect device should be provided as part of the building installation.

**Rack Mount Temperature Considerations:** If the ApexPlus PoE unit is installed in a closed or multi-unit rack assembly, the operating ambient temperature of the rack environment may be greater than room ambient. The maximum ambient temperature of +65°Celsius applies to the immediate operating environment surrounding the PoE unit, which, if installed in a rack, is the ambient within the rack.

**Restricted Access:** The ApexPlus system must be installed in restricted access sites. The PoE unit and associated power supply must be installed in restricted areas, such as dedicated equipment rooms, closets, cabinets, or the like. Access to the tower and ODU/antenna location must be restricted.

**Note:** For USA: In restricted access areas install the ApexPlus system in accordance with articles 110-26 and 110-27 of the **2002 National Electrical Code ANSI/NFPA 70**.

## **Installation Process**

The standard procedure for installing the equipment is as follows:

- 1) Install antenna
- 2) Install previously configured ApexPlus unit on antenna at both ends
- 3) Align antennas
- 4) Proceed to commissioning.

**CAUTION:** ApexPlus has no user serviceable parts, including the cable between the OMU and the ODU. Only factory certified personnel should make any changes or repairs to the units.

## **Preparing for Installation**

### **Tools**

The following tools are required for installation:

Adjustable Open Ended Wrench

Ethernet Cat5e cable crimp tool

#2 Flat screwdriver

#2 Philips Head screwdriver

Stranded 18 AWG wire for power connection

Stranded 12 AWG wire for ApexPlus ODU and OMU ground connections

Wire Insulation strippers for ground and power wire

Terminal crimpers for ground and power wire



## Power Supply

The ApexPlus requires a -48 Volt power supply, however other power supplies will work as long as the voltage at the radio unit is between -40 and -72 VDC. Trango recommends two power supplies

1. -48 VDC, 1U rack mount power supply (part# P-SUPPLY-1U-48) - Powers up to four ApexPlus units



2. -48 VDC universal desktop power supply, 1.6 A (part# PSUPPLY-WM-48L) - Powers one ApexPlus unit.



Each unit is supplied with a two position terminal block that plugs into the ApexPlus main access panel. The wiring of the terminal block should be done as shown below.

The cabling used should be either coaxial (LMR 195 or Equivalent) or two wires of a size no smaller than 18 AWG. If individual wires are used, the wires should be twisted together to reduce susceptibility to noise. At least one turn per inch is recommended.

**NOTE: Ensure that only a -48 Volt Supply is used and that the wiring is correct. If a +48 VDC supply is used and the Earth ground is wired to the negative terminal shown in the figure, permanent damage to the unit may occur.**

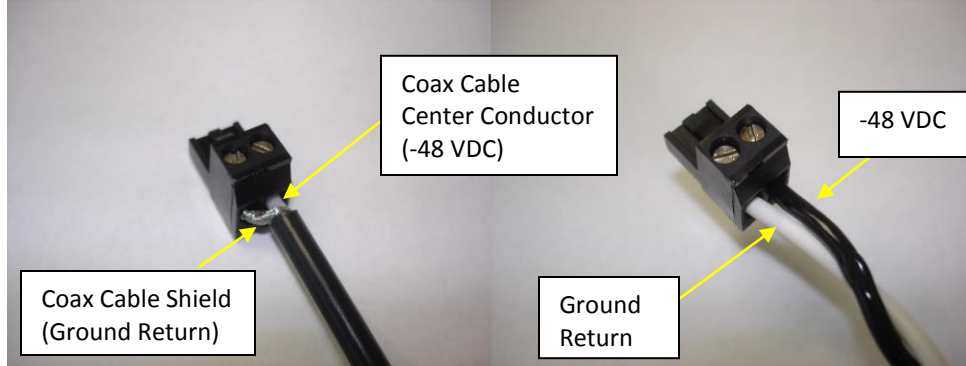

Figure 15- 48 VDC Power Connector using Coaxial Cable and 16 AWG Cable

In the figure above, the Power can be connected in two ways, **Power-over-Ethernet** or **Direct DC Power** as described in the sections below.

## Grounding Diagram

Grounding of the Ethernet cable should be done at the base of the tower using the Terminal Block on the PoE Injector/Surge Suppressor Box. This applies to direct power or PoE powered installations using copper Ethernet. The surge suppression built into the PoE- GigE-48 will help protect network equipment inside the shelter from damage.

A Ground wire of AWG 12 or larger should be used and grounded to an Earth grounded tower leg or Bus Bar before entry into the shelter. Figure 16 shows the overall ground design.

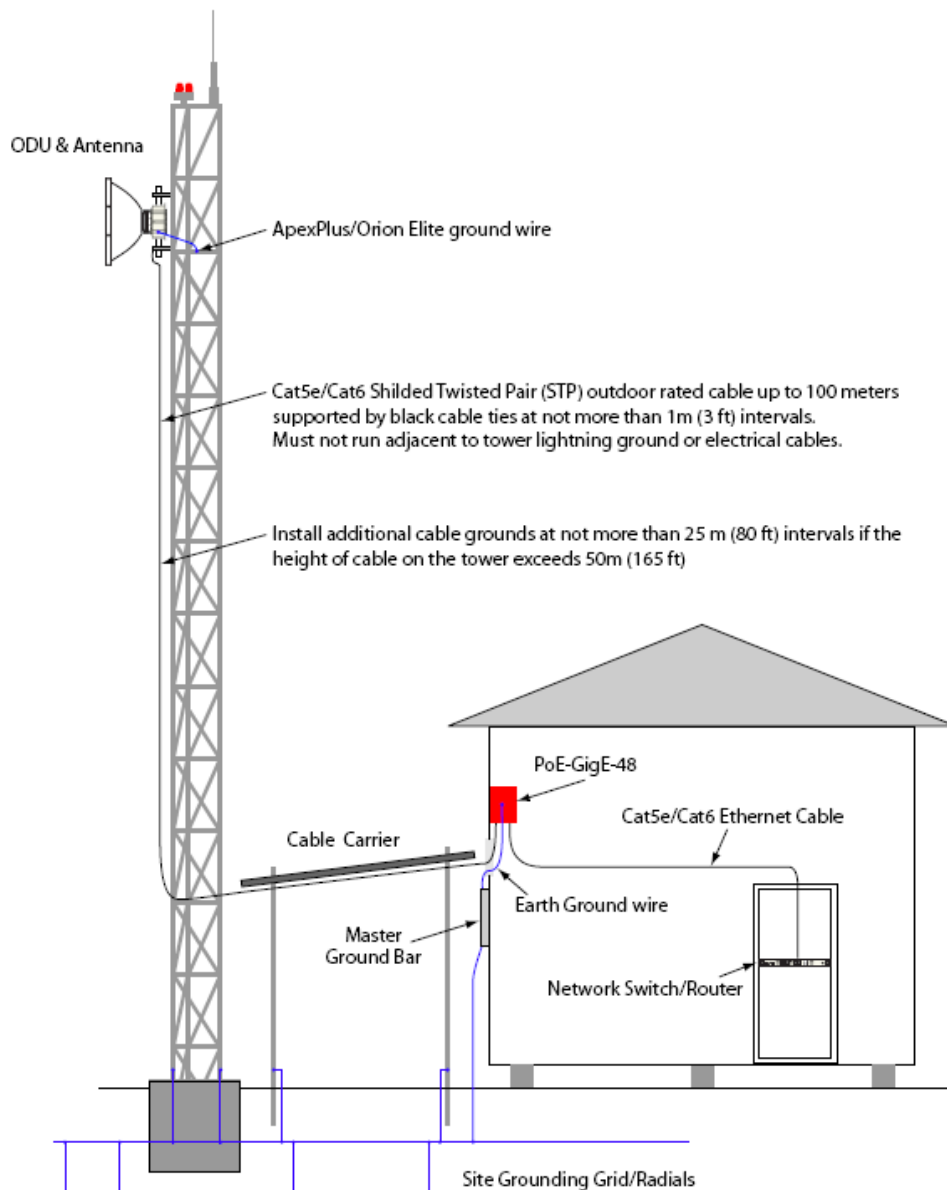

Figure 16 PoE Based Grounding Diagram

## PoE Based Installation

This section covers installation when powering the unit through Power Over Ethernet (PoE) using a single or multiple Cat5e or Cat6 Shielded Twisted Pair (STP) Cable is desired, with copper or fiber traffic interfaces. The POE-GIGE-48 is shown in the Figure below:



Figure 17 POE-GIGE-48

The **PoE Power Injector POE-GIGE-48** can be connected to either of the two copper Ethernet ports:

1. **Out-of-Band Management Port:** Always use a shielded *Cross-Over* Ethernet cable when connecting the out-of-band Management Port to a COMPUTER (see Figure 6).
2. **Data Port:** Always use a shielded *Straight-Through* cable when connecting the Data Port to a HUB, SWITCH, or ROUTER

### IMPORTANT INFORMATION ON THE APEXPLUS PoE

- 1) The PoE is non-standard and will not support 802.3af due to the high current requirements of the radio unit.
- 2) The total length of the Ethernet cabling from network switch to ApexPlus unit cannot exceed 100 meters. This length is the sum of the length of cable from the PoE injector to the ApexPlus unit PLUS the length of cable from the PoE Injector to the network switch.
- 3) Since the PoE Requires **ALL 8 conductors AND the shield** which acts as the ground, it is critical that
  - a. **ONLY** shielded Twisted Pair (STP) Cat5e or Cat6 cabling be used

- b. Shielded connectors are used with the shield crimped properly to the cable shield wire.
  - c. All 8 conductors are wired.
- 4) The PoE Has an “ODU ON” LED that will illuminate solid green when the connection to the ApexPlus is consuming the normal operating current with an input voltage from -40 to -72 VDC. The LED will flash or turn off if the current is below roughly 700 mA, indicating a faulty cable, power supply, or ApexPlus

**If any of the above conditions are not met the PoE function may not work correctly**

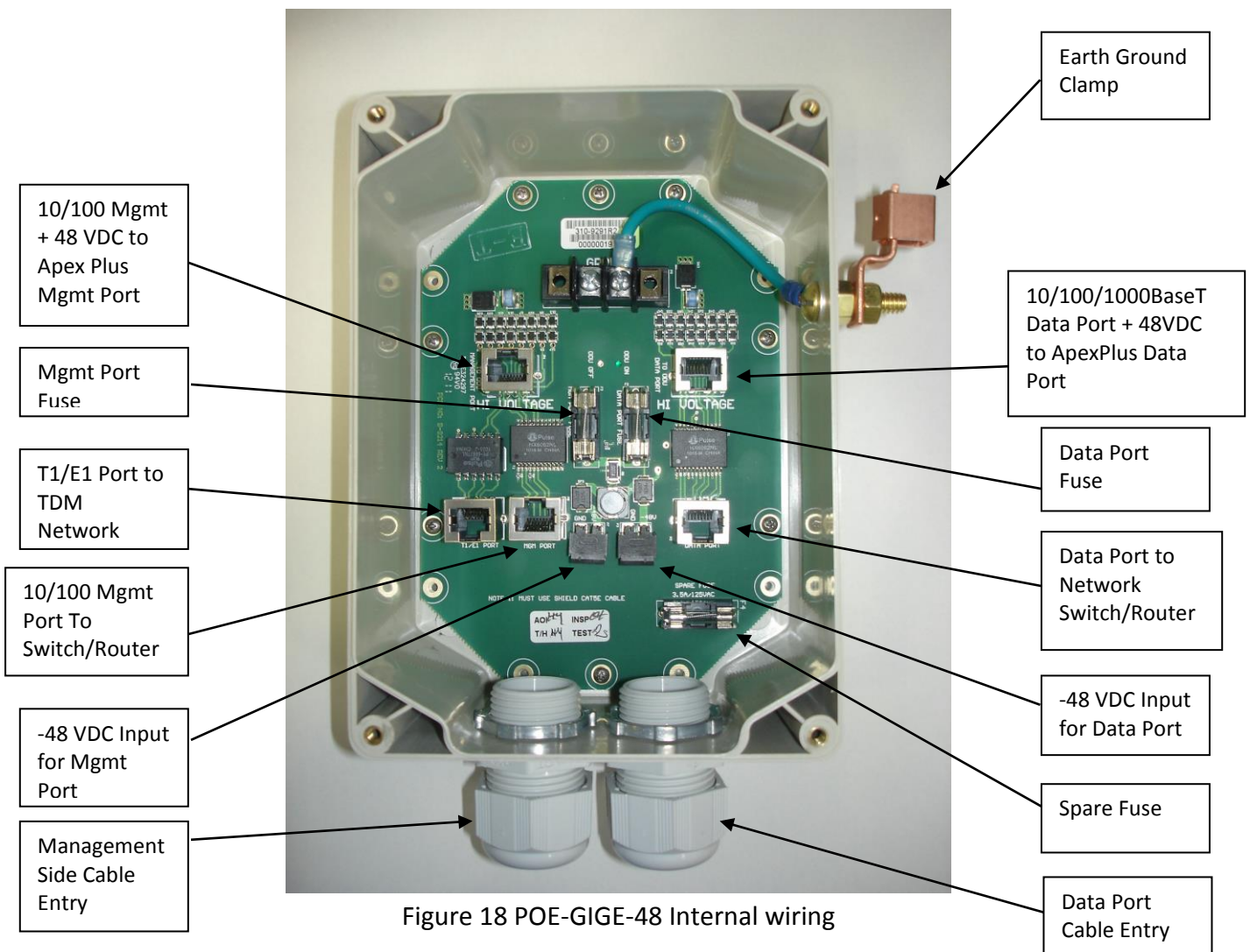

## PoE Based Installation (1+0)

### In-Band Management Only

The wiring for basic 1+0 installation with In-Band Management is shown below. Use this configuration if only one cable is being run from the network switch to the unit and it must carry the data, management traffic, and power.

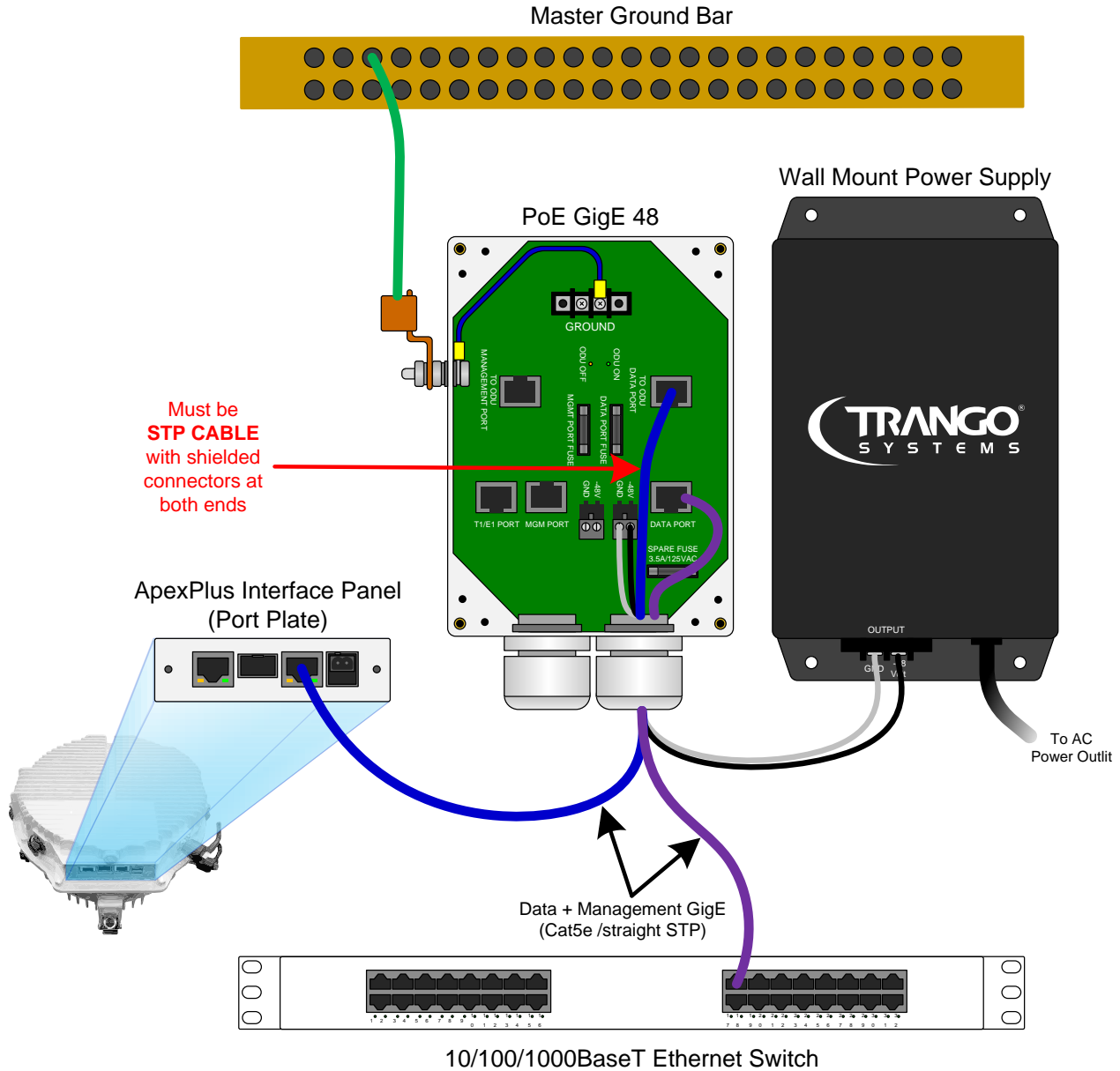

Figure 19 1+0 / IBM PoE Wiring

## In-Band and Out-of-Band Management, Single power Supply

The wiring for basic 1+0 installation with Out-of-Band Management is shown below. Use this configuration if two cables can be used, one for Data and power, and one for management of the radio.

The power may also be applied on the management side only if desired with no change in function. Although it is possible to run the unpowered Ethernet cable directly to the Radio without going through the PoE-GigE-48, no surge protection would be present on the unpowered cable. Both the management and data are protected from surges if wired as shown below.

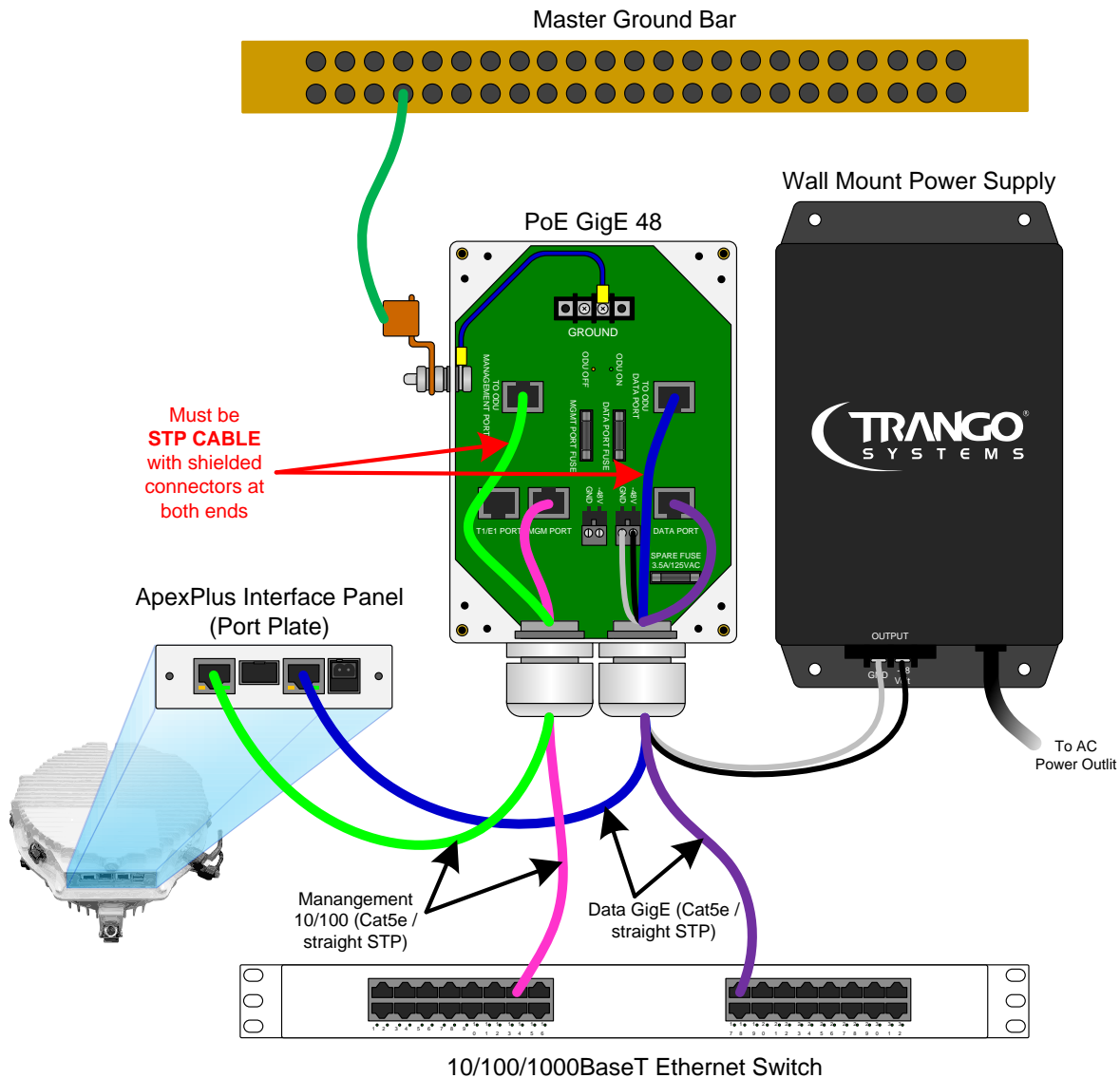

Figure 20 1+0 / OBM PoE Wiring

## In-Band and Out-of-Band Management, Dual Power Supply

The PoE GigE-48 has separate physically isolated and fused circuits to allow powering the same ApexPlus with two separate redundant power supplies as shown below. Both IBM and OBM can be used in this configuration.

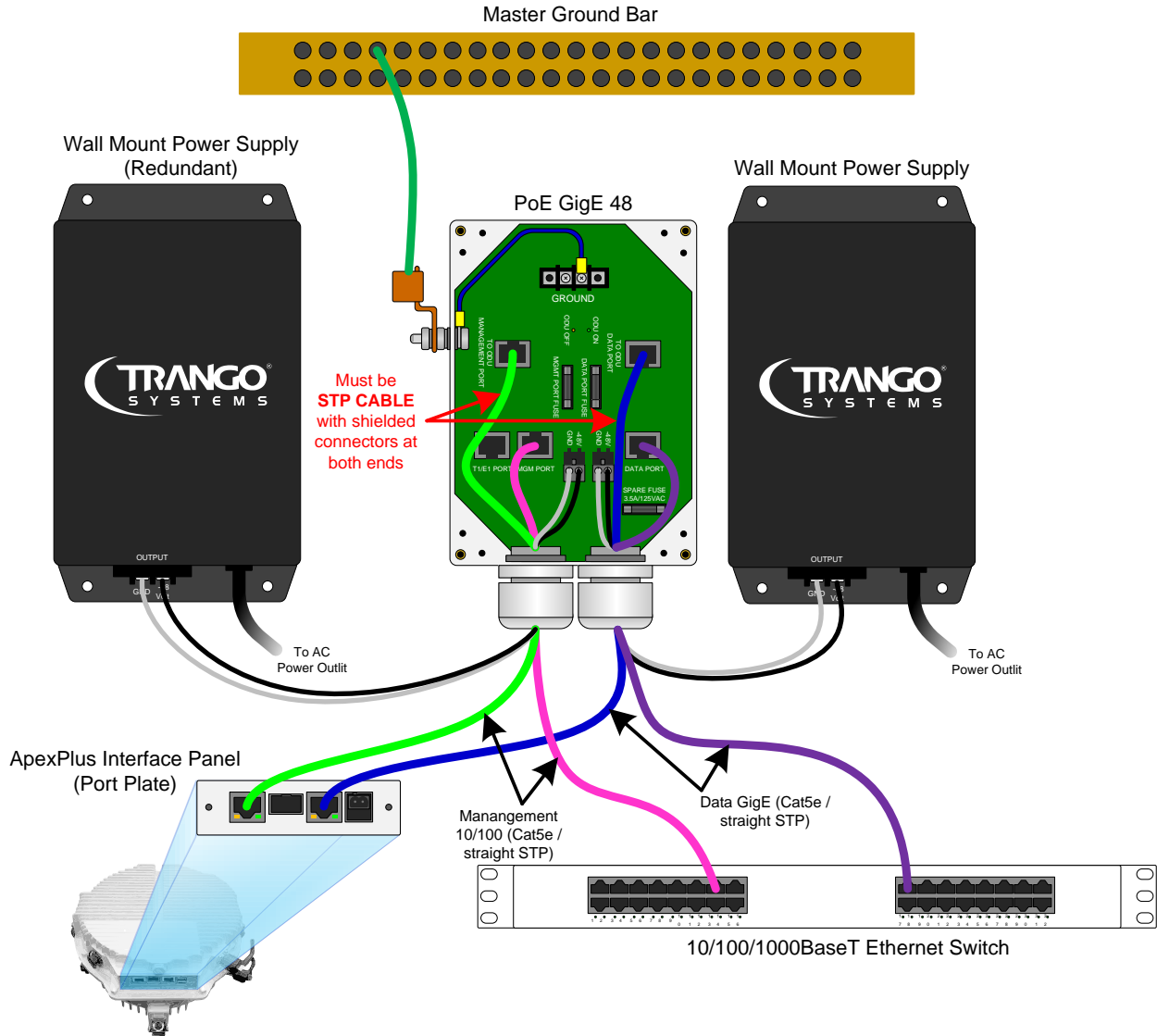

Figure 21 1+0 PoE Redundant Wiring



## **PoE Based Installation (1+1 Hot Standby)**

The installation of the 1+1 hot Standby is similar to the 1+0 installation, except the installation is repeated using a second PoE-GigE-48 and separate power supply for the second standby unit which is mounted on the combiner.

Although it is possible to use a single PoE-GigE-48 to support both the active and standby unit in the 1+1 configuration, it is recommended to use two PoE-GigE-48 PoE Injectors.

## Direct Power Based Installation (1+0)

This section covers installation when powering the unit through the direct -48 Volt DC port and using the Copper or Fiber traffic interfaces is desired.

The primary benefit of direct power is that no surge suppression is required on the traffic interface since fiber can now be used, and the distance to the network can be longer due to the long lengths supported by the fiber and direct power wiring. The 100 meter limitation still applies for any copper Ethernet cabling.

The actual length of the power cable run depends on the wire gauge being used. It is recommended that the voltage be measured at the radio terminals after power-on of the OMU and ODU to ensure it does not fall below the minimum required voltage.

For long runs of Power, coaxial cable is recommended in conjunction with surge suppressors to reduce the risk of voltage spikes causing damage to network equipment.

The Direct Power interface on the front panel is shown below:

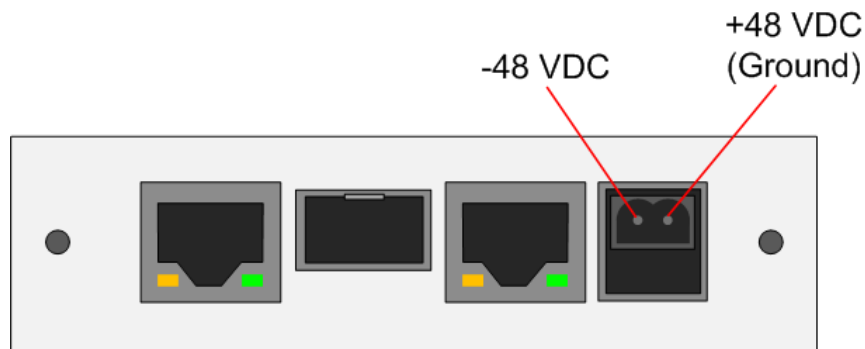

Figure 22 Direct Power Wiring

## Direct Power Based Installation (1+1 Hot Standby)

The installation of the 1+1 hot Standby is similar to the 1+0 installation, except the installation is repeated for the second standby unit which is mounted on the combiner. The CBLDAT-RIU4 is connected between the units.

## ApexPlus ODU Installation on Antenna

The ODU portion of the ApexPlus utilizes a slip fit connection that makes installation simple. The ODUs are all designed to mount to a circular waveguide antenna or combiner with the exception of the 6 GHz models.

For 7 to 40 GHz models, simply rotating the ApexPlus will change the antenna polarization being used.

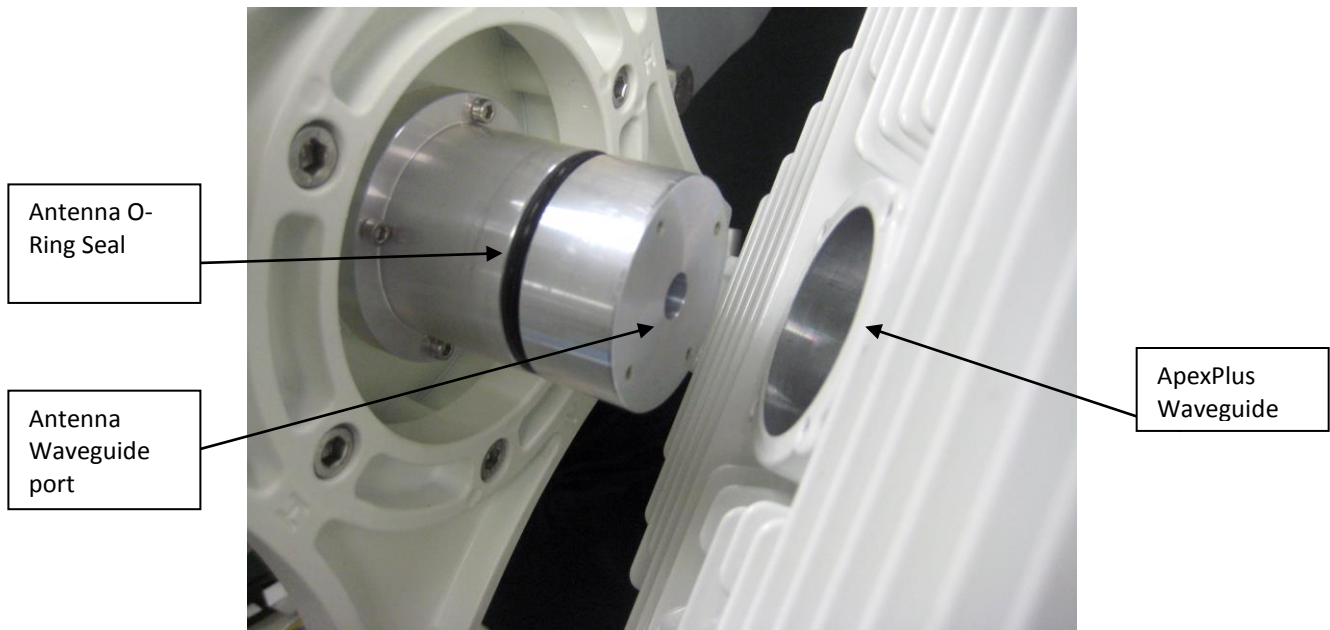

Figure 23 Antenna to ApexPlus Slip Fit Waveguide connection

After installing and securing the antenna the Apex Plus unit can be installed directly on the back of the unit. First, determine which Antenna polarization will be used and ensure that the polarization indicator is at the top of the unit. For vertical polarization the “V” should be at the top of the unit, and for horizontal polarization the “H” should be at the top of the unit.

**Polarization Indicators** – The letters “H” and “V” are die cast on the OMU housing perimeter to assist in mounting the ApexPlus to the antenna in the correct polarization. The letter that is at the top will always indicate the antenna polarization being utilized, for all models.

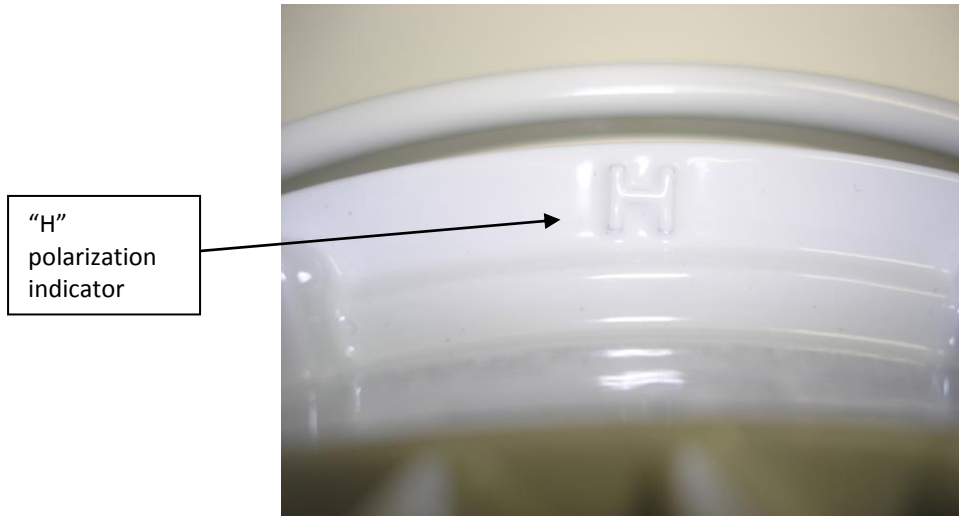

Figure 24 Polarization Indicator

Cover the antenna O-ring with silicone grease per the Antenna manual. Failure to do this may result in a damaged O-ring and subsequent damage to the antenna or radio.

Gently slide the ApexPlus unit onto the antenna and clip the four spring loaded latches to the antenna clips as shown below. The latches should be very snug and “click” into place. If there is difficulty closing the latches, then check the waveguide for debris or foreign matter around the perimeter.

Secure the latches that have eyelets with locks if desired.

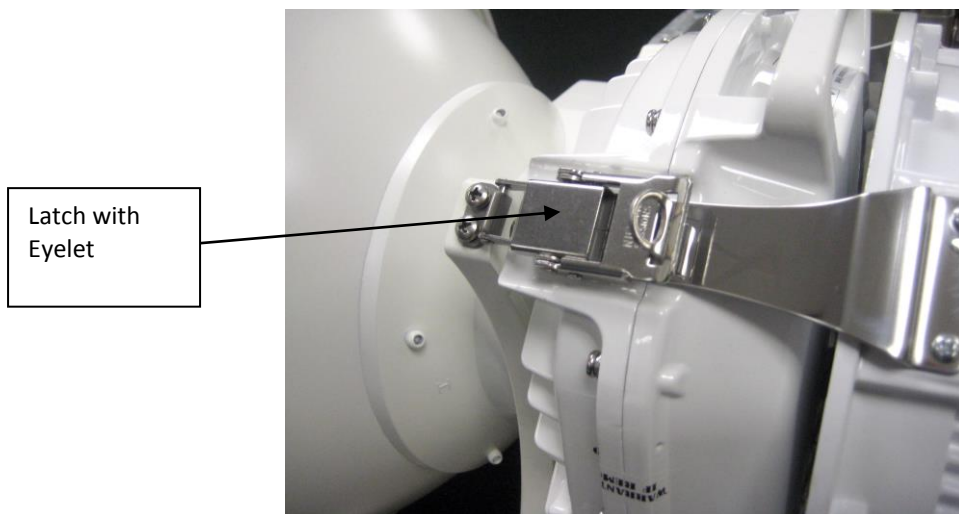

Figure 25 Latches

For AP1-06-xxxx-zz models, both the antennas and radios use a rectangular waveguide opening on the same slip-fit design. The standard polarization is supplied as Vertical. To

change the polarization, the antenna must be changed from vertical to horizontal by rotating either the antenna or the antenna waveguide port

## Cable Installation

ApexPlus is supplied with the following components to seal the cable entry port from weather.

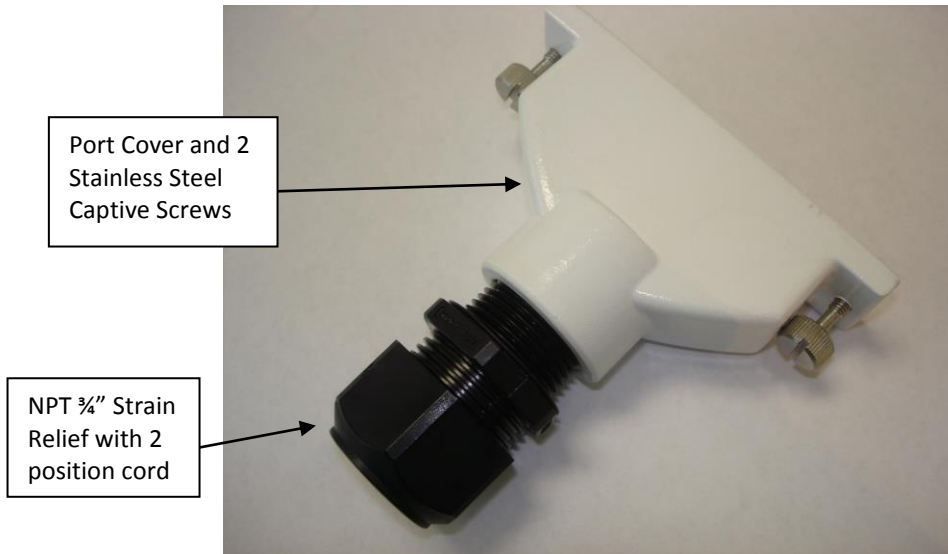

Figure 26 Port Sealing Components

After the Ethernet/Power/Fiber cables are prepared, they should be run through the Cord Grip and port cover and then connected to the ApexPlus ports:

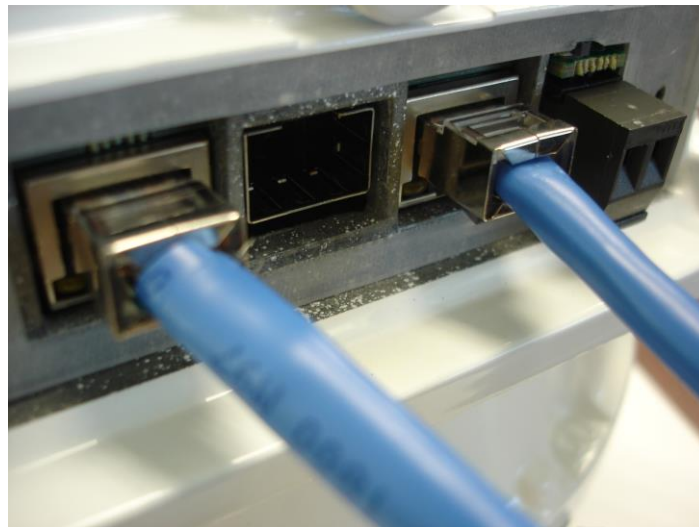

Figure 27 STP Cables installed on Unit

Tighten the two port cover screws using a flathead screwdriver. The screws should be tightened to 8 lb-in to ensure sealing pressure on the silicone gasket around the ports inside.



Figure 28 Detail of the Stainless Steel Thumbscrew

Run the Ethernet cables through the strain relief as shown below. The rubber grommet may need to be cut on the edges to fit cables that have already been terminated with RJ45 connectors. If required, use straight blade to carefully cut the grommet.

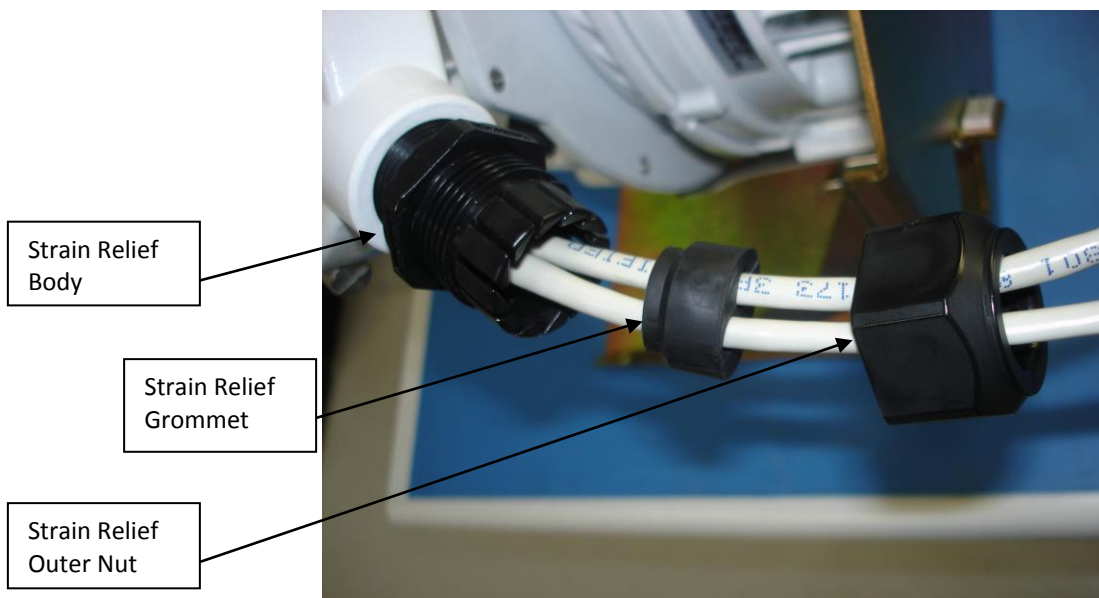

Figure 29 Strain Relief Exploded View

Snug the strain relief body into the port cover as shown below - Teflon tape may be used on the threads but is not necessary. Slide the grommet into the body and tighten the outer strain relief nut. The cables should be held tight by the rubber after the strain relief is tightened. Note – A clicking sound may be heard during tightening which is normal.

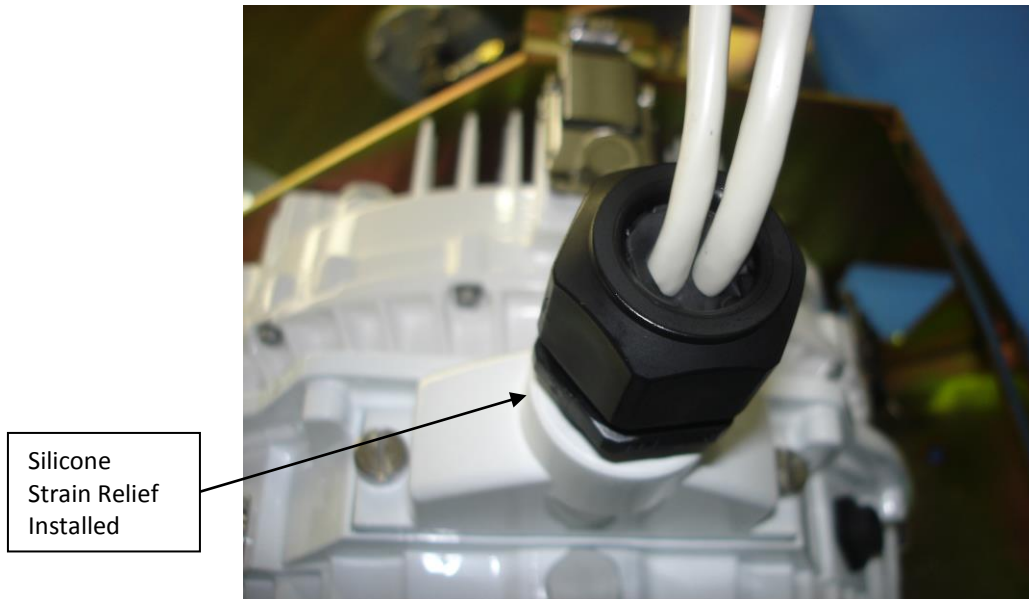

Figure 30 Strain Relief Installed

The OMU ground lug is shown below (next to the OMU to ODU cable). Use the ApexPlus ground wire kit to attach this point and the ODU ground lug to the grounded tower leg where the unit is installed.

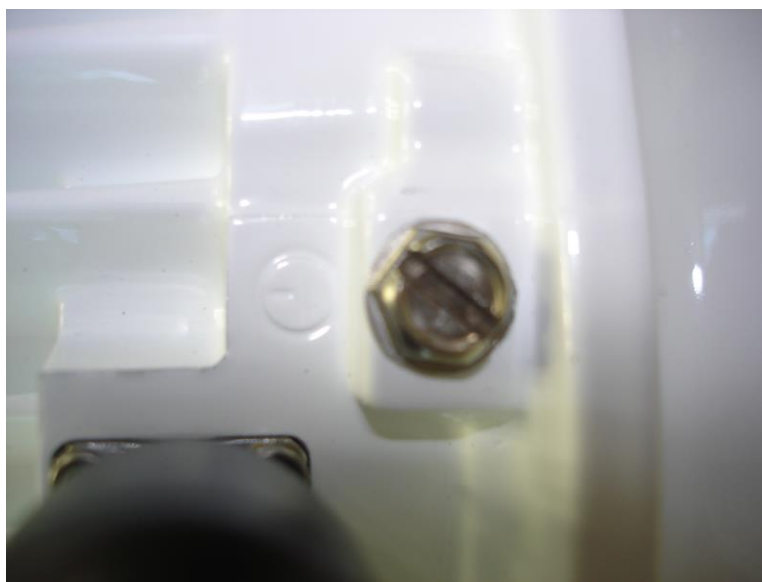

Figure 31 Ground Lug on OMU

## **Antenna Installation**

Antennas are typically installed and are coarse aligned using either visually or with third party equipment. Alternatively, some operators prefer to install the radio equipment onto the antenna prior to installing the antenna on the rooftop or tower.

Consult the specific antenna manual for the antenna being used for detailed installation instructions.

The Link Configuration section covers the alignment of the antennas.



## 7.0 Link Configuration

This section describes the step by step process of configuring a link and making sure it is working properly before installing and putting live traffic on the system.

This section covers basic link establishment for a single link. This setup may be done on the bench or in the field. It is highly recommended that the basic link setup be done on the bench to avoid problems when installing the equipment.

Special bench test setups that provide mounting and fixed or variable attenuation between the RF ports of the units can be obtained from Trango for this purpose. All steps given should be performed on both ends of the link.

**IMPORTANT NOTE: If the link was factory preconfigured at Trango before shipment, this section can be skipped since the proper settings are already in place inside the radio units.**

**Only the IP addresses need to be changed and the Opmode needs to be enabled at both ends. See the Quick Setup Guide for more information.**

## Web Based Configuration

### Web Based 1+0 Setup

The Web interface is the most commonly used way to setup a link. A step by step guide is shown below. To access the Browser interface from the Out-of Band management port, simply connect to the unit using Ethernet cabling, open a web browser and enter the IP address of the radio. The default IP address is 192.168.100.100

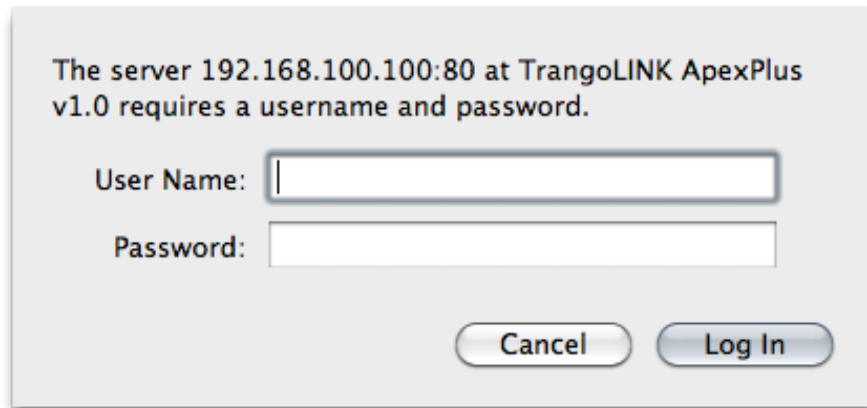

The server 192.168.100.100:80 at TrangoLINK ApexPlus v1.0 requires a username and password.

User Name:

Password:

Cancel Log In

Figure 32 Web Interface Login

#### Step 1: Enter the username and password

A login window will pop up, requiring the user to enter username and password (See Figure 33). There are two web interface access levels, view and config, just like the command line interface. View level allows only viewing link parameters while config level allows changing link parameters. To enter View level, type the default user name and password (user: admin, password: trango) and click OK.

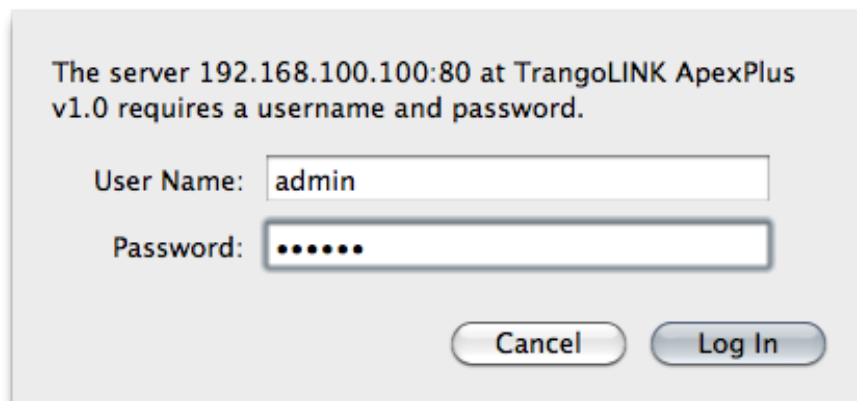

The server 192.168.100.100:80 at TrangoLINK ApexPlus v1.0 requires a username and password.

User Name:

Password:

Cancel Log In

Figure 33 Web Login with Password

Once the user name and password are authenticated, the View level Version page will be displayed as shown below:

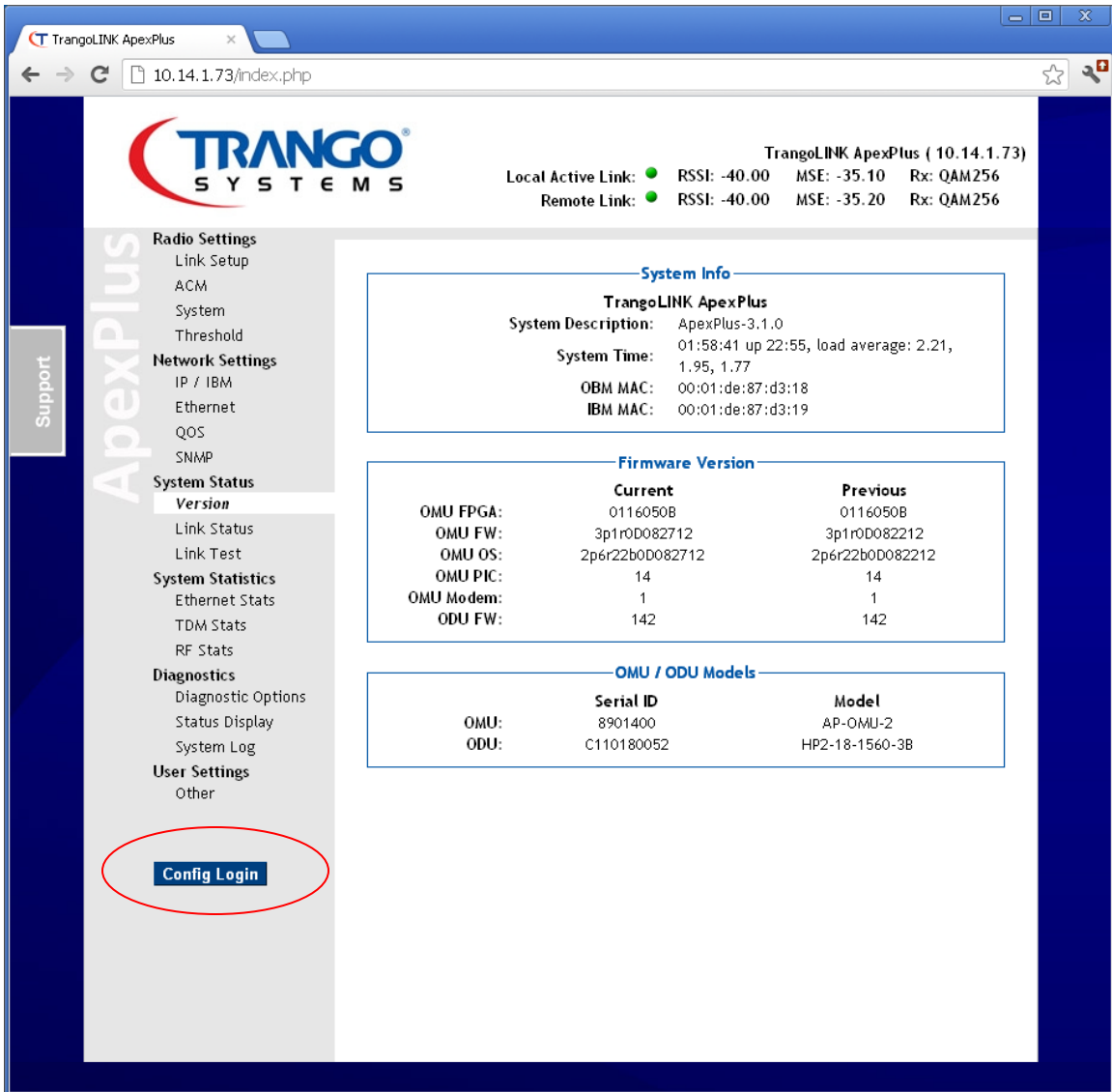
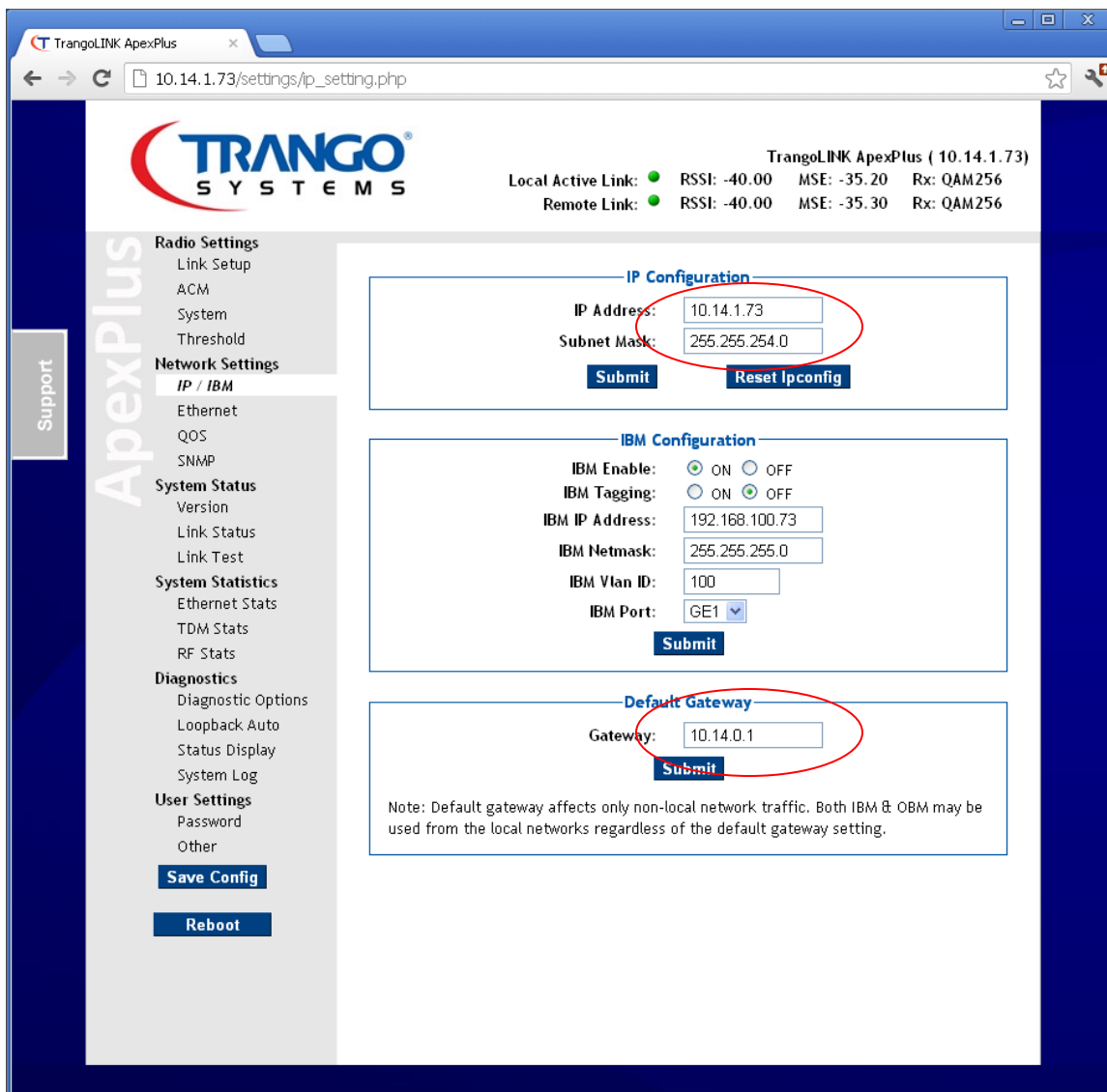

Figure 34 System Status- Version Page

Step 2: Set the IP addresses

- a. Click on the “Config” button in the lower left and sign into the config level web interface at make changes.

- b. Click on the Network Settings folder and IP/IBM configuration page. Set the IP address, Subnet, and Gateway to the address that is desired for the Out-of-band Management Port. Click Submit. At this point the Web session will terminate and the operator must login again using the new IP address.



At this point the Web session will terminate and the operator must login again using the new IP address.

### Step 3: Set the Radio link parameters

All the parameters should match those submitted and approved by the licensing agency, and typically these will have already been programmed by the factory.

- c. Set the Odupower to “On” if it is not already on.
- d. Turn the Opmode to “Off” if it is not already off.
- e. Set the TX frequency, bandwidth, modulation and transmitter power, then click Link Setup. In general, the **Freq Duplex** does not need to be changed unless a non-standard spacing is being used.
- f. After both ends of the link are setup, turn the opmode button “on” to establish the link.

Do not adjust the Failover settings at this time even if 1+1 operation is desired. A normal working link must be set up first before 1+1 is enabled. See the Section on setting up 1+1 for detail on this.

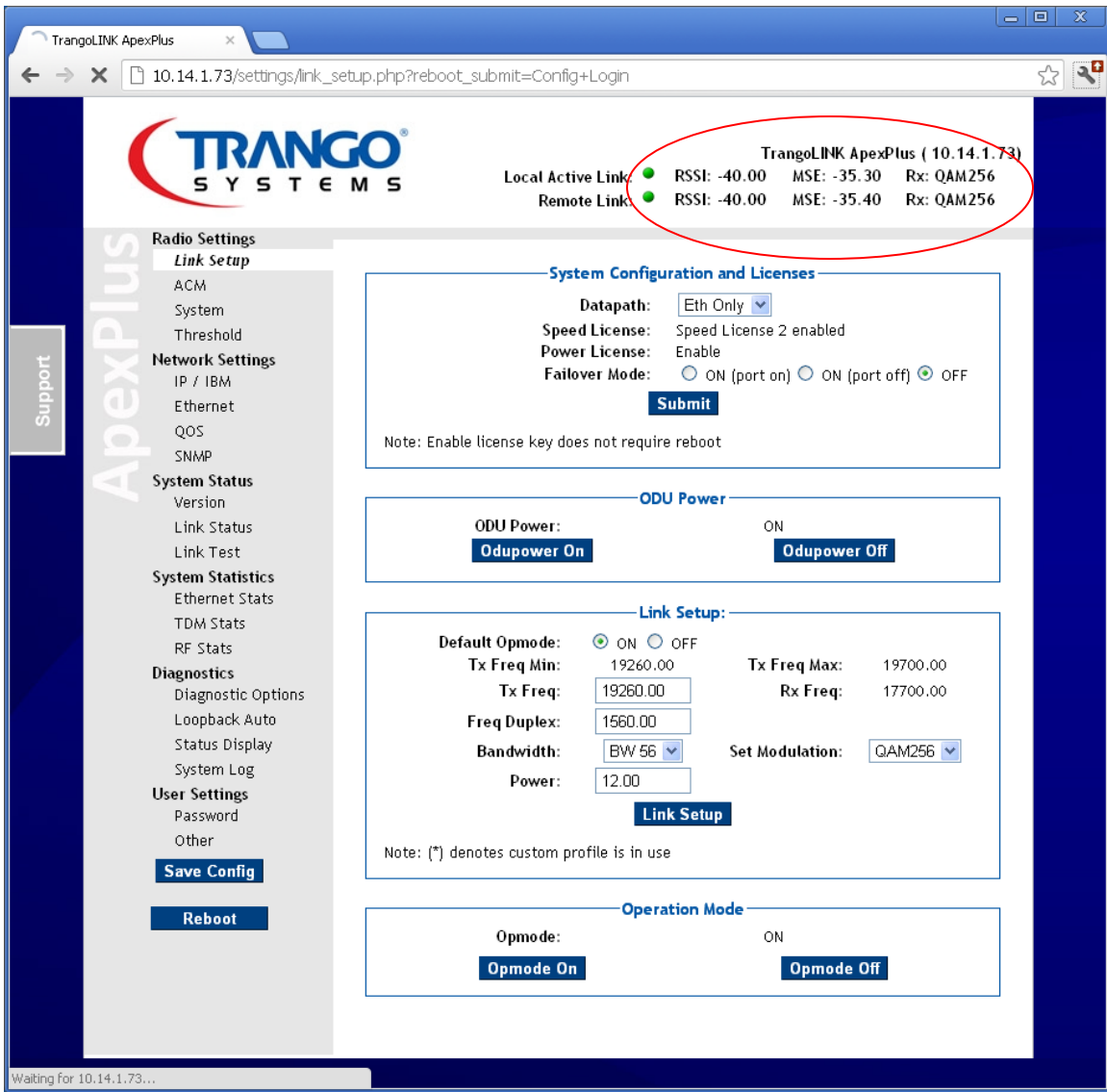

Figure 35 Link Setup Page

The link should now be established between the two sides. The Active Link indicators will turn green and the RSSI and MSE levels will change according to the link distance or attenuation used (if testing in a lab environment)

Click the **Save Config** button at the lower left of any webpage – This must be done on both sides of the link.

## Web Based 1+1 Setup

The 1+1 Setup is an extension of the basic 1+0 setup. 1+1 hot standby utilizes two ApexPlus units connected to a combiner to allow sharing of an antenna at each end of the link. One of the units at each end is the main (active) unit and the other unit is in standby, which means that it is ready to take over should the active unit fail.

This section assumes that the physical installation has been done already. Return to the Installation section and connect the units in a 1+1 configuration if required.

- 1) Follow the steps for 1+0 on the main link as described above with the backup units turned off (-48 VDC disconnected).
- 2) Turn the standby radio units on, but ensure the opmode is off on both to avoid disturbing the active link. Default opmode is off at time of shipment.
- 3) On the Active Link Config Page select the Failover Mode with Port Off button:

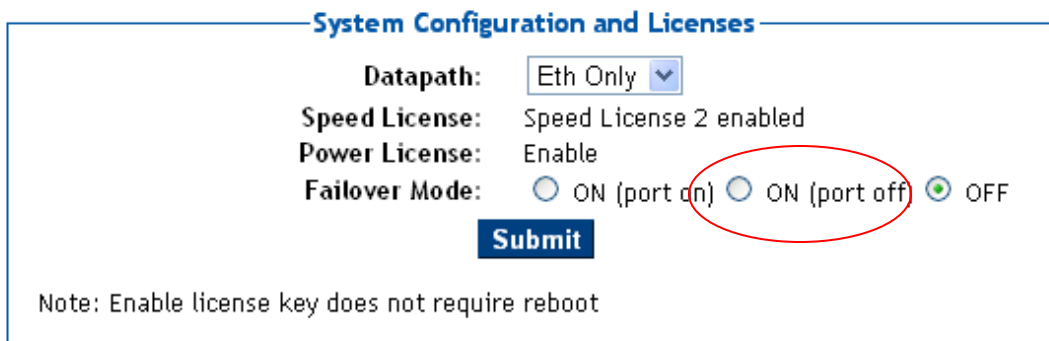

The screenshot shows a web interface titled "System Configuration and Licenses". It contains the following configuration options:

- Datapath: Eth Only (dropdown menu)
- Speed License: Speed License 2 enabled
- Power License: Enable
- Failover Mode:  ON (port on)  ON (port off)  OFF

A red circle highlights the "ON (port off)" radio button, which is currently selected. Below the radio buttons is a blue "Submit" button. At the bottom of the form, there is a note: "Note: Enable license key does not require reboot".

Figure 36 Failover Mode Set

- 4) Repeat for the Active link other end unit.
- 5) The display for the Link status at the top of the page should change to show both Active and Standby units "Green" for all 4 units.
- 6) The system is now setup in 1+1 mode. If the main link fails, the ports will be shut down on the main link and the traffic will flow through the standby link, allowing connected switches to re-route the traffic.
- 7) Click the **Config Save** button at the lower left of any webpage – This must be done on both sides of the link.

### Adaptive Coding and Modulation (ACM) (Optional)

Enabling ACM permits configuration of the MSE Improve and Degrade thresholds. It is recommended to use the default values for best performance. Select the “On” button and then click on the submit button to make the change if ACM is desired.

**Adaptive Modulation (ACM):**

	<b>ACM enable:</b>	<input type="radio"/> ON	<input checked="" type="radio"/> OFF
<b>Modulation</b>	<b>MSE Improve</b>	<b>MSE Degrade</b>	
QPSK	<input type="text" value="-20.30"/>	N/A	
QAM16	<input type="text" value="-25.30"/>	<input type="text" value="-18.50"/>	
QAM64	<input type="text" value="-29.20"/>	<input type="text" value="-24.30"/>	
QAM256	N/A	<input type="text" value="-27.20"/>	

**Submit**

Figure 37 ACM Setup



## Automatic Transmit Power Control (ATPC) (Optional)

Enter the max power levels for each modulation level and enable ATPC to increase system gain during channel fading conditions. The target RSSI should be set to match the normal operating RSSI based on the path calculation. The system will attempt to maintain the target RSSI by sending requests to increase or decrease the transmit power to the other end of the link. When the max power levels are set to the same value for all modulations, it is only recommended to use ATPC for extremely short links where the max power would be higher than the max allowable receiver input.

**TRANGO SYSTEMS**

TrangoLINK ApexPlus ( 10.14.1.73 )

Local Active Link: ● RSSI: -40.00 MSE: -35.20 Rx: QAM256  
 Remote Link: ● RSSI: -40.00 MSE: -35.30 Rx: QAM256

**ApexPlus**

- Radio Settings
  - Link Setup
  - ACM
  - System**
  - Threshold
- Network Settings
  - IP / IBM
  - Ethernet
  - QOS
  - SNMP
- System Status
  - Version
  - Link Status
  - Link Test
- System Statistics
  - Ethernet Stats
  - TDM Stats
  - RF Stats
- Diagnostics
  - Diagnostic Options
  - Loopback Auto
  - Status Display
  - System Log
- User Settings
  - Password
  - Other

**ATPC Setting**

ATPC:  ON  OFF

ATPC Step Size:

ATPC Max Power(QPSK):

ATPC Max Power(Q16):

ATPC Max Power(Q32):

ATPC Max Power(Q64):

ATPC Max Power(Q128):

ATPC Max Power(Q256):

Target RSSI:

**Submit**

**Custom Profile**

Custom Profile: No custom profile in use

Custom Add/Remove:  Add  Remove

**Submit**

**System Setting**

Telnetd:  ON  OFF      Tftpd:  ON  OFF

RPS:  ON  OFF      Smart Mode:  ON  OFF

**Submit**

**Status Snapshot**

**Status Save**

**Save Config**

**Reboot**

Figure 38 ATPC Setup/ RPS /Telnetd/ tftpd

## Command Line Interface (CLI) Based Configuration

### CLI Based 1+0 Configuration

This section covers all the basics that are normally required for setting up the link using either the telnet, SSH, or serial COM port to access the units. Step by step instructions with session examples are given. The CLI interface has more functions available than the Web Interface. Simply type the “?” to see a list of available commands.

#### Step 1: Connect to Each Unit via one of the CLI interfaces

In all the examples given, telnet was used, but the login procedure is similar for each. To log into each ApexPlus units using the default IP address of 192.168.100.100.

Use the windows telnet program or any other telnet client program. When prompted for the Login enter **admin** and for password, enter **trango**. The Trango Systems command line interface application should respond as follows:

```
Microsoft windows XP [Version 5.1.2600]
(C) Copyright 1985-2001 Microsoft Corp.
```

```
C:\Documents and Settings\user>telnet 192.168.100.100
```

```
CLI login: admin
Password:
```

```
Trango System: TrangoLINK ApexPlus Command Line Interface v1.0.0
```

When logging into the radio unit, the operator always enters the (CLI-view)# node, from which only status of the system can be seen. To make changes to system settings, the operator must enter the (CLI-config)# node of to allow changes to the system to be made. Type the command **config** and the password **trango**. The password can be changed later.

```
(CLI-view)# config
Password:
```

#### Step 2: Change the Out of Band (OBM) Management IP Address

It is recommended to change the IP address on both ends of the radio first, before installing the link to ensure that no problems will be encountered accessing the units in the field from the destination network subnet

To change the IP address of the system, first check the ip settings using the *ip* command.

```
(CLI-config)# ip
IP Address:          10.14.1.41
Subnet Mask:         255.255.0.0
Gateway IP:         10.14.1.1
ETH0 MAC:           00:01:de:87:cd:ac
ETH1 MAC:           00:01:de:87:cd:ad
```

Next, change the IP address and subnet mask. The system will not be responsive after the change. Reconnect to the ApexPlus using the new IP address.

```
CLI-config)# ipconfig ip 10.14.1.41 255.255.254.0
IP Address:          10.14.1.41
Netmask:             255.255.254.0

SUCCESS
```

After re-connecting, change the gateway address as necessary.

```
(CLI-config)# ipconfig gateway 10.14.0.1
Gateway IP:         10.14.0.1

SUCCESS
```

Confirm that the changes are made:

```
(CLI-config)# ip
(CLI-config)# ipconfig
IP Address:          10.14.1.41
```

```
Subnet Mask:          255.255.254.0
Gateway IP:           10.14.0.1
ETH0 MAC:             00:01:de:87:cd:ac
ETH1 MAC:             00:01:de:87:cd:ad
```

### Step 3: Turn the ODU Section of the radio on

Type **odupower on** to apply power to the Radio section of the unit. After the CLI returns the status of “**on**”, enter **model** to show the models, serial numbers, TR spacing and transmit frequency range of the unit.

```
(CLI-config)# odupower on
ODU Power enable:      on

SUCCESS

(CLI-config)# model
OMU Model:             AP-OMU-1
OMU Serial ID:         8900004
ODU Model:             HP2-23-1232-1A
ODU Serial ID:         C 2010DEC80001
Tx Freq Min:           21200.00
Tx Freq Max:           21500.00
Freq duplex:           1232.00 (MHz)
```

### Step 4: Set the Transmitter and Receiver Center frequency

The center frequency must be within the min and max shown in the model command and must be at least ½ of the occupied transmitter bandwidth away from the limits for proper operation.

Enter the transmit frequency in MHz (the resolution of the frequency is .250 MHz). The receive frequency will automatically be programmed as follows:

For A models, RX Freq = TX freq + Freq Duplex.

For B models, RX Freq= TX Freq – Freq Duplex.

In some cases the Freq duplex can be changed, but typically this will not be necessary. Changing the Freq duplex will automatically change the RX frequency.

First set the local end transmit frequency:

```
(CLI-config)# freq 21472
Tx Freq:                21472.00 (MHz)
Rx Freq:                22704.00 (MHz)
Freq duplex:           1232.00 (MHz)
```

Next, Set the far end transmitter frequency (separate session with the other radio)

```
(CLI-config)# freq 22704
Tx Freq:                22704.00 (MHz)
Rx Freq:                21472.00 (MHz)
Freq duplex:           1232.00 (MHz)
```

If the system has been installed and the far end transmitter is also on the link can be checked using the *linktest* command

```
(CLI-config)# linktest
          LOCK      RSSI      MSE      BER
1>          1      -45.00  -36.70  0.00E+00
```

#### Step 5: Enable Adaptive Coding and Modulation (ACM) (Optional)

If ACM is desired, the *acm enable* command should be used on both ends of the link.

**IMPORTANT: After the ACM is enabled after initial link establishment, the speed command must be reissued.**

```
(CLI-config)# acm enable on
ACM enable:          on
```

SUCCESS

The two steps above must be done on both ends of the link, starting with the unit that does not have output band management or which relies on the ApexPlus IBM connection for management

#### Step 6: Set the Speed and Modulation

The speed setting may require a license key if the resulting payload speed is above 100 Mbps.

```
(CLI-config)# speed
Modulation:          128QAM
Bandwidth:           20.00
Symrate:              17.42
Speed:                111.00
```

#### Step 7: Enable the Transmitters

Turn **opmode on** on both ends of the link. This enables the transmitter on the unit. After the opmode is turned on, the TX frequency cannot be changed unless opmode is turned off again.

```
(CLI-config)# opmode on
Opmode:              on
```

SUCCESS

#### Step 8: Verify the link is working

Run the **linktest** command to confirm that the link is running properly after enabling ACM. Notice that the Tx and Rx modulation levels are now shown. Now, if the link conditions degrade due to rain fading, either the Tx or Rx may downshift during the fade event. Running the **linktest** command again will show the lower modulation such as 64QAM, 32QAM, etc. for Tx or Rx. The RSSI will also likely change for rain fading, but may remain unchanged if the link degradation is due to multipath. The modulation/RSSI will automatically return to the set value once the fading condition has passed.

```
(CLI-config)# linktest
```

	LOCK	RSSI	MSE	BER	Tx	Rx
1>	1	-38.00	-35.00	0.00E+00	128QAM	128QAM

### Step 9: Save the configuration

Run the ***config save*** command to save all the settings that were changed into non-volatile FLASH memory. If a power interruptions should occur, the link should re-establish itself after the interruption is over.

## CLI Based 1+1 Hot Standby Configuration

This section assumes that the physical installation has been done already. Return to the Installation section and connect the units in a 1+1 configuration if required.

Steps to configure 1+1 Hot Standby:

- 1) Follow the 1+0 configuration section to establish a link between the two main ends of the link, with the second pair of radios turned off. The antennas should be aligned at this point.
- 2) For both ends of the main link:
  - a. Set the failover function to ON using the ***failover*** command .
  - b. Set ***opmode on*** .
  - c. Set ***default\_opmode on***.
  - d. Save the configuration using ***config save***
  - e. Power both ends of the link down.
- 3) Bring the second link (Standby) up using the same configuration as the main pair.
  - a. Set the failover function to ON using the ***failover*** command on both ends of the standby link.
  - b. Save the configuration using ***config save***
  - c. Power both ends of the link down.
- 4) Connect the redundancy cable CBLDAT-RIU4 between the two units.
- 5) Power both main link up
- 6) After the link is established, power up the second link.
- 7) After the election period expires, the two units at each end (active and standby) should sync up with the proper utype and configuration settings.
- 8) Verify by running the failover command and observing the status.



## Antenna Alignment

After Basic Setup of the link, the antennas can be aligned.

Aligning narrow beam width ( $< 2^\circ$ ) over long distances can be a difficult process without the proper equipment, patience, and a careful process.

Using a GPS compass and the Path Analysis to establish a crude azimuth and elevation, the installation crew can mount the Antenna Assembly on the supporting structures at each end of the link. Once the antennas are installed and a rough antenna alignment has been established, then the fine alignment process can begin at one end of the link (typically the site with the smaller antenna).

Once one side is aligned to achieve best RSSI, MSE, and BER then the operator can adjust the other side to improve the link. Alignment can be done using the `linktest` command from the command line interface, or the voltage indication from the BNC connector on the ODU.



Figure 39 BNC Connector for RSSI Voltage

Run the `linktest` command while aligning the antenna and look for the MSE to improve (a higher negative number) while adjusting. When the lock status changes to 1, you may fine tune the alignment with the LED display

### Antenna Alignment Procedure

1. Ensure that both sides of the link are configured correctly.
2. Connect to the management port of the ApexPlus.

3. Login to the end of the link that is being aligned.
4. Run **linktest 99** command while adjusting the antenna(s), and monitor the BNC output voltage until the expected voltage/RSSI level is reached.

The voltage at the BNC will range from 0.1 Volts at -90 dBm input level to 4.5 Volts at -20 dBm input level. Use a voltmeter and CBLDAT-RSSI to monitor the voltage while adjusting the antenna. The following equation can be used to determine the RSL within 3 dB accuracy

$$\text{RSL (dBm)} = 15.77 \times V_{\text{BNC}} - 91.58$$

Below is a table showing the voltage to RSL for convenience.

Voltage (Volts)	RSSI (dBm)
0.1	-90
0.25	-87.6
0.5	-83.7
0.75	-79.8
1	-75.8
1.25	-71.9
1.5	-67.9
1.75	-64
2	-60
2.25	-56.1
2.5	-52.2
2.75	-48.2
3	-44.3
3.25	-40.3
3.5	-36.4
3.75	-32.4
4	-28.5
4.25	-24.6
4.5	-20.6

Table 12 RSSI to Voltage Conversion

5. Once satisfied with the RSSI reading, tighten down the antenna in the optimum position.
6. Replace the sealing cap on the BNC connector and tighten until it clicks into place.

## CLI Common Task Reference

### Setting up the In-Band-Management (IBM)

Trango pre-configures the links with IBM already set up and enabled, however it will typically be necessary to change the IBM IP addresses used to fit the application management network and if management across the network is desired, a VLAN must be setup on the attached switches. This section covers the setup of the IBM.

Display the IBM settings. In the example below the IBM is off.

```
(CLI-config)# ibm
IBM Enable:          off
IBM Vlan ID:        4085
IBM Port:           ge1-copper
IBM IP address:     172.16.1.1
IBM Netmask:        255.255.0.0
```

SUCCESS

Enable IBM using the settings preloaded.

```
(CLI-config)# ibm enable on
IBM enable:  on
```

SUCCESS

Change the IBM IP address and subnet mask. Each end of the link should have a different IP address, and in the case of multiple daisy chained links , the IPs should all be different.

```
(CLI-config)# ibm ip 172.16.1.2 255.255.255.0
IBM IP Address:  172.16.1.2
IBM netmask:    255.255.255.0
```

SUCCESS

Verify the settings are correct.

```
(CLI-config)# ibm
IBM Enable:          on
IBM Vlan ID:         4085
IBM Port:            ge1-copper
IBM IP address:      172.16.1.2
IBM Netmask:         255.255.255.0
```

Verify the connection to the other end of the link by entering the debug node and using the ping command inside the ApexPlus. In the example, the other end of the link has an IP address of 172.16.1.1.

```
(CLI-config)# debug
```

Ping the other side of the link using the **ping** command from within the debug node of the radio.

```
# ping 172.16.1.1
PING 172.16.1.1 (172.16.1.1): 56 data bytes
64 bytes from 172.16.1.1: seq=0 ttl=64 time=6.672 ms
64 bytes from 172.16.1.1: seq=1 ttl=64 time=1.001 ms
64 bytes from 172.16.1.1: seq=2 ttl=64 time=0.979 ms

--- 172.16.1.1 ping statistics ---
3 packets transmitted, 3 packets received, 0% packet loss
round-trip min/avg/max = 0.979/2.884/6.672 ms
```

Return to the command line interface using the **cli** command. Upon returning from the debug prompt, the system will be in the view node, so the user must log into the config node if any further changes are required.

```
# cli
```

```
Trango System: TrangoLINK ApexPlus Command Line Interface v1.0.0
```

Return to the config node using the **config** command

```
(CLI-view)# config
```

```
Password:
```

### Capacity License Activation

Activate the traffic capacity license if needed. License keys are typically installed at the factory prior to shipment. Should the operator wish to re-enter the license keys, use the **license** command as shown below

```
(CLI-config)# license 2 <alphanumeric key>
```

```
License:                License 2
```

```
SUCCESS
```

### Automatic Transmit Power Control (ATPC) Configuration (optional)

Configure the Automatic Transmit Power Control (ATPC) if required. ATPC is typically only required if the the link is so short that the max transmit power cannot be used due to receiver overload, or for regulatory reasons.

First check the ATPC status. If the ATPC is off then the ATPC can be enabled using the **atpc enable on** command. In the example below the max power is currently 19 dBm

```
(CLI-config)# atpc
```

```
ATPC Enable:            on
```

```
ATPC Step Size:        1
```

```
ATPC Max Power:        19.00
```

Next, set the ATPC max power based on the highest modulation that will be used. In the example below, the highest transmit power that will be used is +17 dBm, so the **atpc max\_power** is set accordingly.

```
(CLI-config)# atpc max_power 17
ATPC max power:          17.00
```

SUCCESS

```
(CLI-config)# atpc
ATPC Enable:             on
ATPC Step Size:         1
ATPC Max Power:         17.00
```

Next, set the target receiver level that will be used to control the far end transmitter power. If the RSSI is too high, then the ATPC software will send an ATPC power down command to the other end of the link.

The **targetrssi** must be set on both ends of the link, just as the ATPC max power. The ATPC software will stop sending commands to the other end of the link when the RSSI is inside + / - 2 dB of the target rssi set level.

```
(CLI-config)# targetrssi
Target RSSI:             -45.00
```

```
(CLI-config)# targetrssi -40
Target RSSI:             -40.00
```

SUCCESS

## Check Ethernet and RF port Statistics

Run the **status port** command

This command shows the current Ethernet port statistics and to provide confirmation that the connection to the network equipment is set up properly. The system default is auto-negotiate. The ge1 and ge2 are mapped to the copper and SFP data ports respectively, and the ge0 port is the interface from the internal switch inside the ODU to the modem.

The ge0 statistics are typically not monitored and are made available for troubleshooting purposes only. The RF counters indicate the statistics for the receive port and the transmit port.

The Octet/Packet counts on the RF counters may be slightly higher due to internal messaging between the two ends of the link for internal link management, and again they are primarily for troubleshooting purposes and do not need to be monitored continuously.

Monitoring the RF drop counts is useful for determining if errors are occurring over the wireless portion of the link.

The port rate and port utilization (percent) are also useful for monitoring since they can indicate a link running at capacity. These two metrics account for the sum of all the Ethernet ports being used.

```
(.72-config)# status port

<===== Ethernet Counters =====>
Port:                ge1          ge2          ge0
Enable:              on           on           on
Status:              on           off          on
Duplex:              full         full         full
Speed:               1000        1000        1000
In Octets:           2598150077    0           1168476128
In Ucast Pkt:        1852535353    0           3364786732
In NUcast Pkt:       0             0           0
In Port Rate:        347           0           286
In Port Util:        34            0           28
Out Octets:           4087505152    0           1939268960
Out Ucast Pkt:       3352202931    0           3565551594
Out NUcast Pkt:      0             0           0
Out Port Rate:       269           0           221
Out Port Util:       26            0           22
CRC Errors:          0             0           0
CollisionError:      0             0           0

<===== RF Counters =====>
                IN                OUT
Total Octets:    1872251772            3582899144
Total Pkt:       4133016647            4158172838
Total Drop Pkt:  0                    N/A
Port Rate(Mbps): 296                    229
Port Util(per):  81                    62
```

Run the **status clear** command

After the link has been established and the Ethernet interfaces are running properly, the counters may all be cleared. This is typically done just prior to the link validation phase in which a fixed amount of traffic or packets are passed over the link over a period of

time to ensure no drops occur. The status clear command will clear all port counters and the BER counters.

```
(CLI-config)# status clear
```

Run the **syslog clear** command

Before deployment it is a good idea to clear the syslog so that only events after the link was commissioned are recorded. Run the syslog clear command.

```
(CLI-config)# syslog clear
```

```
(CLI-config)# syslog
```

```
Current 0:19:24:25.990
```

View the model information using the **model** command

```
(CLI-view)# model
OMU Model:          AP-OMU-1
OMU Serial ID:     8900004
ODU Model:         HP2-23.00-1232-0A
ODU Serial ID:     C 2010DEC80001
Tx Freq Min:       21200.00
Tx Freq Max:       21500.00
Freq duplex:       1232.00 (MHz)
```

### Enable Traps (Optional)

Traps can be used to notify external network monitoring devices that a threshold parameter has been crossed. Thresholds re available for the following:

- RSSI
- MSE
- BER
- FER
- OMU\_TEMP
- ODU\_TEMP
- OUT PORT UTILIZATION (percentage of max available)
- IN PORT UTILIZATION (percentage of max available)
- LINK DOWN



If thresholds have been set and an SNMP trap assigned as an action, the crossing of the threshold will generate a trap.

The current trap information using the **trap** command. The current trap manager IP addresses are shown along with their individual status:

```
(CLI-config)# trap
                IP                Enable
Trap 1:         0.0.0.0            off
Trap 2:         0.0.0.0            off
Trap 3:         0.0.0.0            off
Trap 4:         0.0.0.0            off
Trap 5:         0.0.0.0            off
```

Set the trap 1 manager IP address using the **trap ip** command – repeat for additional trap manager ip addresses:

```
(CLI-config)# trap ip 1 10.14.1.5
                IP                Enable
Trap 1:         10.14.1.5          off
```

SUCCESS

Enable the trap number 1 using the **trap enable 1 on** on command – The trap will be enabled and the status shown:

```
(CLI-config)# trap enable 1 on
                IP                Enable
Trap 1:         10.14.1.5          on
```

## 8.0 Troubleshooting

This section provides troubleshooting advice for problems that may be encountered during setup and normal operation of the system.

### **Symptom: No Link (Lock = 0 during linktest)**

- 1) TX Frequency must EXACTLY match the RX frequency on the remote side. Type **freq** command from the CLI to view. Verify that the frequencies used match the regulatory body (FCC or equivalent) approved frequencies.
- 2) Opmode is off. Run **opmode** command to view, and run **opmode on** to enable. If the unit was rebooted and the default opmode is not on, the unit will come back on but the opmode will be off. To prevent, run **default\_opmode** on command and **config save**.
- 3) Are the frequencies configured correctly on each radio (TX and RX)? High frequency on the “B” side and low frequency on the “A” side..
- 4) Is the ApexPlus unit installed properly on the remote mount (remote mount applications only)? The radio unit will only operate in a single orientation on the remote mount. Follow the directions on the remote mount to ensure correct installation. The arrows on the Remote mount must be aligned with the “V” on the ApexPlus unit.
- 5) Are both ApexPlus units mounted on the same polarization? ApexPlus units must be mounted with matching polarizations at each end of the link. If one side is mounted on the antenna differently than the other side, the link will not lot or the signal level will be 20-30 or more dB lower than expected.
- 6) IF ACM is being used, ACM may not be enabled on both ends of the link. Enable the ACM and reset the speed on each end. The speed must be set the same on both ends.

### **MSE is too high and/or bit errors are showing when running linktest**

**NOTE: MSE= -32 dB or lower is typical for 256 QAM, -29 is a worse number and is not typical**

- 1) Is the transmitter power set too high for the current modulation being used. Consult the license information to verify that the power level is no higher than the maximum allowed for the highest modulation that will be used.
- 2) Target RSSI setup may be incorrect. It is best to set the target RSSI as high as possible without overdriving the receiver for the most robust operation. Setting the target RSSI too close to the RX sensitivity threshold will compromise the link integrity.
- 3) Are both ApexPlus radios mounted on the same polarization? ApexPlus radios must be mounted with matching polarizations at each end of the link. If one side is mounted on the antenna differently than the other side, the link will not lock or the signal level will be 30 or more dB lower than expected.
- 4) Is the ApexPlus unit installed properly on the remote mount (remote mount applications only)? The radio unit will only operate in a single orientation on the remote mount. Follow the directions on the remote mount to ensure correct installation. The Arrow on the remote mount must line up with the “V” on the ApexPlus unit.
- 5) Presence of microwave transmitters on same frequency (uncommon): To check for possible interference from other licensees, turn off the opposite end transmitter and run the *rssI* command. The signal level should be -90 or lower. The level should be steady within a dB or so.

#### **Receive Signal Level is too low**

- 1) Target RSSI setup may be set incorrectly. It is best to set the target RSSI as high as possible without overdriving the receiver for the most robust operation. Setting the target RSSI too low will result in a signal level lower than what is expected if ATPC is enabled .
- 2) Reported RSSI more than 3 dB off the expected RSSI: There may be a alignment problem with the antenna, especially if both sides of the link show the same symptom..

Solution: Realign the antenna(s). Opmode must be on at the remote side of the link to do alignment of the local side. Ensure that ATPC is off..

- 3) Are both ApexPlus radios mounted on the same polarization? ApexPlus radios must be mounted with matching polarizations at each end of the link. If one side is mounted on the antenna differently than the other side, the link will not lock or the signal level will be 30 or more dB lower than expected.
- 4) Is the ApexPlus unit installed properly on the remote mount (remote mount applications only)? The radio unit will only operate in a single orientation on the remote mount. Follow the directions on the remote mount to ensure correct installation. The Arrow on the Remot mount must line up with the “V” on the ApexPlus unit.

**RF Link is good but packet loss is occurring:**

- 1) Verify the duplex and speed settings in the Ethernet port are correct (100 or 1 Gbit) and match the connected equipment, and that no CRC errors on the port are occurring.
- 2) Verify that the Ethernet ports are connected properly. The ApexPlus family of Radios are port mapped, meaning that the traffic going into Ethernet Port 1 on the local side will only appear at port 1 of the remote side, local side port 2 traffic will appear on the remote side port 2, etc..
- 3) Check the Ethernet cables for correct wiring. If 1000BaseT is being implemented, Cat6 cable should be used. Ensure that the cable is shielded and proper grounding is applied to the RJ45 connector.

**No Radio Management connection over the link**

- 1) Verify the In-Band management is set up properly - Check to see if the IP configuration is correct, the VLAN ID is set and matches on both ends, and that IBM is enabled.

# ***Appendix A – Command Line Interface Reference***

This Appendix provides a standalone guide to the commands available through the Telnet, SSH, and console port of the ApexPlus.

## **Command Keying Overview**

### **Key Functions**

#### **Tab - Autocomplete**

Completes a partial command name entry. When you enter a unique set of characters and press the Tab key, the system completes the command name. If you enter a set of characters that could indicate more than one command, the system beeps to indicate an error. Enter a question mark (?) immediately following the partial command (no space). The system provides a list of commands that begin with that string.

#### **Del or Backspace**

Erases the character to the left of the cursor.

#### **Return**

At the command line, pressing the Return key performs the function of processing a command. At the –More-- prompt on a terminal screen, pressing the Return key scrolls down a line.

#### **Space Bar**

Allows you to see more output on the terminal screen. Press the space bar when you see the More prompt on the screen to display the next screen.

#### **Left Arrow**

Moves the cursor one character to the left.

#### **Right Arrow**

Moves the cursor one character to the right.

#### **Up Arrow**

Recalls commands in the history buffer, beginning with the most recent command. Repeat the key sequence to recall successively older commands.

#### **Down Arrow**

Return to more recent commands in the history buffer after recalling commands with the Up Arrow or Ctrl-P. Repeat the key sequence to recall successively more recent commands.

## Different Node Levels

### View Node

This is the default node the users log in. This is strictly for viewing configuration and statistics only. No configuration changes can be made at this level.

### View Node Command List

acm	Display ACM feature status
atpc	Display ATPC status
ber	Display ber test parameters
config	Enable Trango configuration mode
cos	Display current status for class of service
datapattern	Display data source for data pattern
date	Display Time of Day
default_opmode	Display default opmode status
failover	Display failover mode
freq	Display Rf Tx/Rx frequency
guard_time	Display failover guard time
help	Display help command
httpd	Display Web server (httpd) status
lbn	Display In Band Management configuration
ipconfig	Display radio management port configuration
license	Display license enable status
link_history	Display Link history
linktest	Display link test values (RSSI, MSE, BER)
loglevel	Display current syslog logging level
loopback	Display loopback Mode

model	Display OMU/ODU Model and serial number
mse	Display the MSE (Mean Square Errors) value
odupower	Display ODU -48VDC Supply Power status
opmode	Display Operation Mode status
power	Display Tx power in dBm
remark	Display Location remarks
rps	Display current status of rapid port shutdown
rsi	Display RSSI value
show	Show running system information
siglevel	Display the signal levels for debugging
snmpd	Display SNMP Agent Daemon (snmpd) status
speed	Display current modulation and symbol rate(speed)
status	Display status for different device and ports
sync_status	Display 1+1 synchronization status
sysinfo	Display all system settings
syslog	Display system event log
targetrsi	Display target rsi value
telnetd	Display telnetd server (telnetd) status
temp	Display OMU and ODU temperature
tftpd	Display tftp server (tftpd) status
trap	Display SNMP Trap IP configuration
uptime	Display system uptime
utype	Display the unit type (1+1 configurations)
version	Display IDU/ODU Software version
voltage	Read onboard voltage values from PIC

## Config Node

Users can enter this node by typing in the command “config” from the view node. They will be prompted for a password and after successful authentication users enters the config mode. All configuration settings can be changed here.

- All the commands entered without any parameters returns the current configured values and are similar to “view” node.
- All configuration changes are applied immediately and don’t require any reboot (except “speed” in which the settings are applied immediately, but it does require reboot after save).
- All configuration changes have to be saved in order to be persistent across reboot. A single “save” command will save all configuration changes
- Users can go back to the “view” node by typing in the command exit

## Config Node Command List

CLI	Input Value Range	Default Value
<b>acm</b>	enable <on off>, mod <modulation> mse_im <value> mod <modulation> mse_de <value>	Off See Table See Table
<b>atpc</b>	enable <on off> max_power <0-30> step_size <1-5>	Off 17 1
<b>ber</b>	N/A	N/A
<b>bootimage</b>	<upgrade   toggle> <omu odu>	N/A
<b>config</b>	<export   remove   view   save>	N/A
<b>cos</b>		Priority 0: COS Queue = 0 Priority 1: COS Queue = 0 Priority 2: COS Queue = 1 Priority 3: COS Queue = 1 Priority 4: COS Queue = 2 Priority 5: COS Queue = 2 Priority 6: COS Queue = 3 Priority 7: COS Queue = 3



<b>custom_profile</b>	<add   remove>	N/A
<b>datapath</b>	<0   1   2 >	0 (Ethernet Only)
<b>datapattern</b>	<fpga   modem>	fpga
<b>date</b>	<0-99><1-12><1-31><0-23><0-60>	Linux System Date
<b>debug</b>	N/A	N/A
<b>default_opmode</b>	<on/off>	Off
<b>diagnostic</b>	N/A	N/A
<b>egress_margin</b>	< -90 to +90>	N/A
<b>exit</b>	N/A	N/A
<b>failover</b>	<0   1   2>	0 (Off)
<b>freq</b>	depends on ODU model	0 (this is exception to the valid range)
<b>freq_duplex</b>	depends on ODU model	Dependent on ODU model
<b>ftp</b>		N/A
<b>guard_time</b>	< >	15
<b>help / ?</b>	N/A	N/A
<b>httpd</b>	<on/off>	On
<b>ibm</b>	<on/off> <ip address> <port> <tagging> <vlanid>	On
<b>ipconfig</b>	<ip address><netmask><gateway>	ip            192.168.100.100 netmask:    255.255.255.0 gateway:    192.168.100.100  Reset will not reset ipconfig, use “reset ipconfig” to reset the ip address settings.
<b>license_power</b>	< license key> for transmit power extension.	No key installed
<b>license_speed</b>	< license key> for radio capacity	No key installed
<b>link_history</b>	N/A	N/A
<b>linktest</b>	duration <1-99>	Default 1 (if duration not entered by user)
<b>loglevel</b>	<0: Setting, 1: Event, 2: Status>	0,1

<b>loopback</b>	<dig   if   off>	Off
<b>loopback_auto</b>	<5-120>	N/A
<b>model</b>	N/A	No defaults, read directly from the OMU/ODU
<b>mse</b>	duration <1-99>	Default 1 (if duration not entered by user)
<b>odupower</b>	<on/off>	Off
<b>opmode</b>	<on/off>	Off
<b>passwd</b>	<passwd> <confirm_passwd> (8char)	trango
<b>port</b>	<eth > <1-2> <auto_negotiate, duplex, enable, maxrate, pause, priority, speed	Both ports configured in the Auto-Neg Mode. Port 2 only supports 1000BaseT
<b>power</b>	<0-30>	10 dBm
<b>prompt</b>	Character string	N/A
<b>qos</b>	<dscp_weight> <0-7> <1-16> <mode> <0   1>	N/A N/A
<b>qos_info</b>	N/A	N/A
<b>reboot</b>	N/A	N/A
<b>reload</b>	<1-240> <cancel>	N/A N/A
<b>remark</b>	<string 1-100bytes>	TrangoLink ApexPLUS Reset will not change the remark settings
<b>reset</b>	N/A	N/A
<b>rps</b>	on/off	off
<b>rsi</b>	Duration <1-99>	Default 1 (if duration not entered by user)
<b>show</b>	<passwords>	CLI View Node: trango CLI Config Node: trango SNMP read comm: public SNMP write comm: private Web Interface: trango

		snmp trap: trapstr
<b>siglevel</b>	N/A	N/A
<b>smart_mode</b>	<on   off >	On
<b>snmpd</b>	<on   off >	On
<b>speed</b>	<channel_bw> <modulation>	<0> <qam16>
channel_bw	4/7/10/14/20/28/30/40/50/55/56/80	10
modulation	qpsk, qam16, qam32, qam64, qam128, qam256	qam128
<b>status</b>	<modem   fifo   pll   port   all   clear>	N/A
<b>sync</b>	N/A	N/A
<b>sync_status</b>	N/A	N/A
<b>sysinfo</b>	<0-6>	0 (if command executed without any param)
<b>syslog</b>	<clear>	N/A
<b>targetrssi</b>	<-88 - -25)	-40
<b>tdm</b>	N/A	N/A
<b>telnetd</b>	on/off	off
<b>temp</b>	N/A	N/A
<b>tftpd</b>	on/off	off
<b>threshold</b>	value <param> <min   max> <value> action <param> <action>	Default action is None. Min/max parameter values vary by parameter.
	<b>param</b> : 0 -rssi, 1 -mse, 2 -ber, 3 -fer, 4 -omu_temp, 5 -odu_temp,6 -in port util, 7 -out port util 8-link down	
	<b>min   max</b> : param dependent	
	<b>action</b> : 0 -none, 1 -snmptrap, 2-failover	
<b>trap</b>	<enable  ip   cr>	Reset will change the prev configured trapip
enable	<0 - 5>	Off
ip	<1 -5 > <A.B.C.D>	0.0.0.0

<b>cr</b>	N/A	N/A
<b>uptime</b>	N/A	N/A
<b>utype</b>	N/A	Main
<b>utype_switch</b>	N/A	N/A
<b>version</b>	N/A	N/A
<b>tftpd</b>	on/off	Off
<b>web_refresh_rate</b>	<0  2-300>	0 = no refresh

## Debug Node

This node is additional management port related settings and users enter the debug node, by typing in the *debug* command from the config node. Users can re-enter the view node by entering the *cli* command from within the debug node.

### Debug Node Command List

<b>cli</b>	N/A	Used to Enter the CLI (trango-view) node
<b>exit</b>	N/A	Close the session
<b>factory_default</b>	N/A	Reset all setting to factory default including !P address
<b>help</b>	N/A	display list of commands in the debug node
<b>passwd</b>	trango	Change the password for admin admin level
<b>ping</b>	<ip address>	ping network hosts
<b>route</b>	N/A	display the current system routing table
<b>ssh</b>	<ip address>	ssh into another host
<b>syslog</b>	N/A	print system log
<b>uptime</b>	N/A	display uptime
<b>telnet</b>	<ip address>	telnet into another host
<b>tg_reboot</b>	N/A	Reboot radio

## Individual Command Details

### acm

<p><b>SYNTAX</b></p>	<p><i>acm</i></p> <p><i>acm enable &lt; on   off &gt;</i></p> <p><i>acm mod &lt;modulation&gt; mse_im &lt;-40 - 0&gt;</i></p> <p><i>acm mod &lt;modulation&gt; mse_de &lt;-40 - 0&gt;</i></p> <table border="1" data-bbox="456 636 1323 1056"> <thead> <tr> <th>profile</th> <th>mse_im</th> <th>mse_de</th> <th>enable</th> </tr> </thead> <tbody> <tr> <td>QPSK</td> <td>-20.3</td> <td>N/A</td> <td>enabled</td> </tr> <tr> <td>16QAM</td> <td>-25.3</td> <td>-18.5</td> <td>enabled</td> </tr> <tr> <td>32QAM</td> <td>-26.3</td> <td>-21.3</td> <td>enabled</td> </tr> <tr> <td>64QAM</td> <td>-29.2</td> <td>-24.3</td> <td>enabled</td> </tr> <tr> <td>128QAM</td> <td>-32.1</td> <td>-27.2</td> <td>enabled</td> </tr> <tr> <td>256QAM</td> <td>N/A</td> <td>-27.2</td> <td>enabled</td> </tr> </tbody> </table> <p>Configuration Storage: Yes</p> <p><i>acm</i> without any parameter will display the current status of ACM threshold value and enable options.</p>	profile	mse_im	mse_de	enable	QPSK	-20.3	N/A	enabled	16QAM	-25.3	-18.5	enabled	32QAM	-26.3	-21.3	enabled	64QAM	-29.2	-24.3	enabled	128QAM	-32.1	-27.2	enabled	256QAM	N/A	-27.2	enabled
profile	mse_im	mse_de	enable																										
QPSK	-20.3	N/A	enabled																										
16QAM	-25.3	-18.5	enabled																										
32QAM	-26.3	-21.3	enabled																										
64QAM	-29.2	-24.3	enabled																										
128QAM	-32.1	-27.2	enabled																										
256QAM	N/A	-27.2	enabled																										
<p><b>DESCRIPTION</b></p>	<p><i>acm</i> is used to display ACM features parameters including ACM enable, and MSE values in the improve/degrade threshold tables.</p> <p><i>acm enable</i> is used to turn on the adaptive modulation feature. When enabled, the current Rx modulation may shift to different profile based on the current MSE value and a set of pre-defined MSE degrade and improve thresholds.</p> <p><b><i>The speed command must be issued after “acm enable on/off” command.</i></b></p> <p>ACM is not symmetric and each end (Tx Rx) may have different profiles at a given time depending upon the MSE values on each end.</p> <p><i>acm mod</i> is used to update MSE value for degrade or improve threshold table. The new threshold values should be effect immediately upon execution.</p> <p>Certain profiles are not available when initial speed modulation is at QAM256. Below are</p>																												

the available profiles:

profile	mse_im	mse_de	enable
QPSK	-20.3	-17.10	enabled
16QAM	-25.3	-18.5	enabled
64QAM	-29.2	-24.3	enabled
256QAM	-32.1	-27.2	enabled

Note: Enable/disable certain profile functionality is not supported in this release.

**Note:** RPS should be disabled prior to enabling ACM, then re-enabled after the link is established with ACM active to prevent inadvertent disconnection of the Ethernet port and loss of management.

## atpc

<p><b>SYNTAX</b></p>	<p><i>atpc</i></p> <p><i>atpc enable &lt; on   off &gt;</i></p> <p><i>atpc max_power &lt;0-30&gt;</i></p> <p><i>atpc step_size &lt;0-5&gt;</i></p> <p>Default: enable OFF, max power 17 dBm, step size 1</p> <p>Configuration Storage: Yes</p> <p><i>atpc</i> without any parameter will display the current status of ATPC feature</p>
<p><b>DESCRIPTION</b></p>	<p><i>atpc</i> is used to display ATPC features parameters including ATPC step size, ATPC enable, and ATPC max power.</p> <p><i>atpc enable:</i> ATPC is used to automatically adjust the remote end ODU transmit power in order to maintain the desired level of RSSI (within 2 dB range of <i>targetrssi</i>) at the local end. This feature will work only when both local and remote radio are enabled.</p> <p><i>atpc max_power:</i> Set the maximum ATPC power. This parameter is used only when the ATPC is enabled.</p>

	<p>User cannot execute the <i>power</i> command when ATPC is turned on. The system will adjust the power automatically based on the “max_power” and “step_size”.</p> <p><i>atpc step_size</i>: Specified the step size for each of the ATPC command for power up/down</p> <p>By default, for each of the <i>atpc</i> power up/down command from the remote unit, there will be 1 dB increment/decrement. The user may specify this step size to maximum of 5 dB per command. The <i>power</i> command to ODU is 1 dB at a time, but will go up to number of step size per ATPC command.</p> <p>The operator is responsible for meeting legal/regulatory requirements for Tx power.</p>
<b>EXAMPLE</b>	<i>(CLI-view) atpc</i>

## ber

<b>SYNTAX</b>	<p><i>ber</i></p> <p><i>ber</i> &lt;0-99 duration in seconds&gt;</p> <p>Default: 1 second</p> <p>Configuration Storage: Yes</p>
<b>DESCRIPTION</b>	<p><i>ber</i> without any parameter will display the current BER, LOCK, MSE, RSSI values. This number is calculated by having modem internally generate certain amount of data and monitor the packets to determine the bit error rate.</p> <p><b>Note: The BER might not be accurate. It’s based on packet dropped due to CRC/FCS errors on Ethernet. BER is not relevant on the ApexPlus due to LDPC error correction, wherein the slope is really steep from no errors to link loss [about &lt; 1dB]</b></p>

## bootimage

<b>SYNTAX</b>	<p><i>bootimage toggle</i></p> <p><i>bootimage upgrade</i> &lt;omu   odu&gt;</p>
---------------	--



	<p>Default: N/A</p> <p>Configuration Storage: NO</p> <p><i>bootimage</i> is a system-level command.</p>
<b>DESCRIPTION</b>	<p><i>bootimage toggle</i>: To switch current images back to the previous updated image in a set of FPGA OS, FW. PIC and ODU firmware are not allowed to be toggled back unless performing <i>bootimage upgrade</i> again.</p> <p><i>bootimage upgrade</i>: upgrade the required software images on the radio, after the image has been transferred to the radio via tftp or ftp.</p>

## config

<b>SYNTAX</b>	<p><i>config export</i></p> <p><i>config remove</i></p> <p><i>config save</i></p> <p><i>config view</i></p> <p>Default: N/A</p> <p>Configuration Storage: No</p> <p><i>config</i> is a system-level command.</p>
<b>DESCRIPTION</b>	<p><i>config export</i>:: The option allows the user to create a ASCII file (config.txt) of the current system configuration, which can then be tftp from the PC, which the user can edit/print or import to other system</p> <p><i>config remove</i>: This option allows removing the current system configuration file config.bin and all settings will be reset to factory defaults. This is different than the “reset config” where all the password settings are also being reset.</p> <p><i>config save</i>: Save command is used to save the current system configuration to the flash, so that system settings are persistent across reboot/power cycles.</p>

The *config save* command should be used after system setting change. Otherwise it will be lost after reboot. Multiple changes can be saved by one save command.

*config view*: The option displays the current system configuration in ASCII format on the console. The saved config is displayed.

**COS**

<p><b>SYNTAX</b></p>	<p><i>cos</i></p> <p><i>cos &lt;priority&gt; &lt;queue&gt;</i></p> <p>Default:</p> <table border="1" data-bbox="651 863 1255 1348"> <tr> <td>Priority 0</td> <td>COS Queue = 0</td> </tr> <tr> <td>Priority 1</td> <td>COS Queue = 0</td> </tr> <tr> <td>Priority 2</td> <td>COS Queue = 1</td> </tr> <tr> <td>Priority 3</td> <td>COS Queue = 1</td> </tr> <tr> <td>Priority 4</td> <td>COS Queue = 2</td> </tr> <tr> <td>Priority 5</td> <td>COS Queue = 2</td> </tr> <tr> <td>Priority 6</td> <td>COS Queue = 3</td> </tr> <tr> <td>Priority 7</td> <td>COS Queue = 3</td> </tr> </table> <p>Configuration Storage: YES</p> <p><i>cos</i> is a system-level command.</p>	Priority 0	COS Queue = 0	Priority 1	COS Queue = 0	Priority 2	COS Queue = 1	Priority 3	COS Queue = 1	Priority 4	COS Queue = 2	Priority 5	COS Queue = 2	Priority 6	COS Queue = 3	Priority 7	COS Queue = 3
Priority 0	COS Queue = 0																
Priority 1	COS Queue = 0																
Priority 2	COS Queue = 1																
Priority 3	COS Queue = 1																
Priority 4	COS Queue = 2																
Priority 5	COS Queue = 2																
Priority 6	COS Queue = 3																
Priority 7	COS Queue = 3																
<p><b>DESCRIPTION</b></p>	<p>This command is used to map the priority of the incoming packet to one of the 4 COS queues based on the packet priority per 802.1p. The traffic class of the incoming packet is mapped 1to1 to the 8 priorities.</p> <p>The scheduling is strict priority with</p> <p>COSQ3 &gt; COSQ2 &gt; COSQ1 &gt; COSQ0</p>																

	<p><b>EXAMPLE:</b></p> <pre>(CLI-config)# cos 2 3</pre> <p>COS map priority=2, queue=3</p> <p>SUCCESS</p> <pre>(CLI-config)# cos</pre> <p>COS scheduling:    strict  Priority 0:    COS Queue = 0  Priority 1:    COS Queue = 0  Priority 2:    COS Queue = 3  Priority 3:    COS Queue = 1  Priority 4:    COS Queue = 2  Priority 5:    COS Queue = 2  Priority 6:    COS Queue = 3</p>
--	---

**datapath (future)**

<b>SYNTAX</b>	<pre>datapath &lt;0-4&gt;</pre> <p>0:ETH only  1:ETH+T1  2:ETH+E1</p>
<b>DEFAULT VALUE</b>	0: Eth Only
<b>DESCRIPTION</b>	<p>Select the profile to be used on the datapath of the radio.</p> <p>Bandwidth for TDM is always reserved once selected, regardless of whether data is being sent or not.</p>
<b>RELATED</b>	speed, license

## **datapattern**

<b>SYNTAX</b>	<p><i>datapattern</i> &lt;external   internal&gt;</p> <p>Default: external datapattern</p> <p>Configuration Storage: Yes</p> <p><i>datapattern</i> without any parameter will display the current status</p>
<b>DESCRIPTION</b>	<p>Sets datasource for the modem. <i>datapattern</i> can be generated from either fpga (external) or the modem (internal), used to generate PRBS data for testing purposes.</p> <p>The datapattern should be set to “fpga” during normal mode of operation, otherwise no user data from GigE or the T1 ports will be transmitted.</p>

## **date**

<b>SYNTAX</b>	<p><i>date</i> &lt;year&gt; &lt;month&gt; &lt;day&gt; &lt;hour&gt; &lt;minute&gt;</p> <p>Default: N/A</p> <p>Configuration Storage: No</p> <p><i>date</i> without any parameter will display the current time of date.</p> <p><i>date</i> is a system-level command.</p>
<b>DESCRIPTION</b>	<p>Allow the user to set and read the current time and date</p>

## **debug**

<b>SYNTAX</b>	<p><i>debug</i></p> <p>Default: N/A</p>
---------------	---

	<p>Configuration Storage: No</p> <p><i>debug</i> is a system-level command.</p>
<b>DESCRIPTION</b>	Exit current node and enter the debug mode.
<b>EXAMPLE</b>	<p>To enter debug mode</p> <p>(trango-config)# debug</p> <p>debug&gt;</p>
<b>RELATED</b>	cli

### default\_opmode

<b>SYNTAX</b>	<p><i>default_opmode</i></p> <p><i>default_opmode [on   off]</i></p> <p>Default: default operation mode OFF</p> <p>Configuration Storage: Yes</p> <p><i>default_opmode</i> without any parameter will display the default operational mode</p>
<b>DESCRIPTION</b>	<p>Set the default opmode to user specified input.</p> <p>If ON, the system to power on with ready to be operational</p> <p>if OFF, the user has to explicitly turn on opmode.</p> <p>Opmode settings are dependent upon "default_opmode" after power up</p>

--	--

### diagnostic

<p><b>SYNTAX</b></p>	<p><i>diagnostic</i></p> <p>Default: N/A</p> <p>Configuration Storage: No</p> <p><i>diagnostic</i> is a system-level command.</p>
<p><b>DESCRIPTION</b></p>	<p>Diagnostic command is to communicate with all system devices and get a current snapshot of the system status. This is mainly used for debugging purposes.</p>

### egress\_margin

<p><b>SYNTAX</b></p>	<p><i>egress_margin &lt;-9 0 to -90&gt;</i></p> <p>Default: N/A</p> <p>Configuration Storage: Yes</p> <p><i>egress_margin</i> is a system-level command.</p>
<p><b>DESCRIPTION</b></p>	<p><i>egress_margin</i> allows changing the egress rate from the internal switch to the modem to improve the performance of the strict QoS. If the egress margin is set to 0, then the egress rate is matched to the capacity displayed in the speed command. the egress margin will change this value according to the equation egress rate = channel capacity + egress margin channel capacity.</p> <p>The default setting is sufficient in most cases and will give the best overall capacity, but if mostly small packets are used on the network, the margin may need to be reduced for better enforcement.</p>

## exit

<b>SYNTAX</b>	<p><i>exit</i></p> <p>Default: N/A</p> <p>Configuration Storage: No</p> <p><i>exit</i> is a system-level command.</p>
<b>DESCRIPTION</b>	<p>Exit command is used to logout from the current node to the lower node. Typing <i>exit</i> from the <i>debug&gt;</i> node will bring user to the login prompt.</p>
<b>EXAMPLE</b>	<p>To Switch to view node from “trango-config” node</p> <pre>(trango-config)# exit</pre> <pre>(trango-view)</pre> <p>To logout from the system</p> <pre>debug&gt;exit</pre>
<b>RELATED</b>	<p>cli, config</p>

## failover

<b>SYNTAX</b>	<p><i>failover</i></p> <p><i>failover</i> &lt;0:off, 1: On with port OFF, 2: On with port ON&gt;</p> <p>Default: OFF</p> <p>Configuration Storage: Yes</p>
---------------	--

	<i>failover</i> without any parameter will display the current status for the failover mode
<b>DESCRIPTION</b>	<p>Display and configure the failover mode feature. Failover cable is required between two OMU for this feature to work properly.</p> <p>Option OFF: Disable failover mode feature.</p> <p>Option ON with port OFF: Standby unit disable all Ethernet ports.</p> <p>Option ON with port ON: Standby unit will leave the Ethernet port enabled.</p> <p>When enabled, KeepAlive message will be exchanged between the two ApexPlus OMU to determine their utype.</p>
<b>EXAMPLE</b>	<pre>(CLI-config)# failover Failover mode: off (CLI-config)# failover on Failover mode: on SUCCESS</pre>

## freq

<b>SYNTAX</b>	<p><i>freq</i> [tx_freq in MHz]</p> <p>Default: no default frequency. 0</p> <p>Configuration Storage: Yes</p> <p>The setting of frequency is 250 kHz resolution.</p> <p>EXAMPLE: <i>freq 17727.5</i></p> <p><i>freq</i> without any parameter will display the current Tx and Rx frequency for the ODU.</p>
<b>DESCRIPTION</b>	<p>Sets the transmit frequency and therefore the receive frequency. Only certain Tx-Rx frequency pairs are valid for each model of the radio.</p>



	Certain IDU/ODU PLL synthesizers are programmed for each and every individual frequency.
--	--

### freq\_duplex

<b>SYNTAX</b>	<p><i>freq_duplex</i> [duplex]</p> <p>Default: 0</p> <p>Configuration Storage: Yes</p> <p><i>freq_duplex</i> without any parameter will display the current duplex value</p>
<b>DESCRIPTION</b>	<p>The duplex distance can be set to any valid frequency within the diplexer frequency range for HP and AP1 models. Regulatory and performance specifications may not be met when using non-standard settings.</p> <p>Only some HP2 and AP2 Models are adjustable for specific duplex distances</p> <p>Sets the duplex value to be used for programming the transmit frequency and therefore the receive frequency.</p>
<b>EXAMPLE</b>	<pre>(CLI-config)# freq_duplex ODU duplex:      490.00 (MHz)  (CLI-config)# freq_duplex 500 ODU duplex:      500.00 (MHz)  SUCCESS</pre>

### ftp

<b>SYNTAX</b>	<p><i>ftp</i></p> <p><i>ftp</i> &lt;server_ip&gt; &lt;user_name&gt;</p> <p>ftp&gt; get &lt;file_name&gt;: perform ftp get command. Get file from the ftp server</p> <p>ftp&gt; mode: configure ftp operation mode. Passive or active.</p> <p>ftp&gt; put &lt;file_name&gt; &lt;server path&gt;: perform ftp put command. Put file to the ftp server</p> <p>ftp&gt; logout: logout of ftp session.</p>
---------------	---

	<p>Default: server_ip=NULL, user_name=NULL, mode=Passive</p> <p>Configuration Storage: No</p>
<p><b>DESCRIPTION</b></p>	<p>To perform ftp operation. Provide the command with the ftp server IP address and the user login. Enter the password when prompted.</p> <p>ftp&gt; get &lt;file_name&gt;: Do NOT supply the path to the file that needs to be put on to the. It will be stored in the default system directory</p> <p>See example below.</p> <p>ftp&gt; put &lt;source file&gt; &lt;destination&gt;: source will be the filename only,. Destination will include both path and file name.</p> <p><b>Note:</b> file on the ftp server might need to be deleted before it can be downloaded with the same file name.</p> <p>ftp&gt; mode &lt;mode&gt;: Default operation mode is Passive and can be configure as active with the mode option.</p> <p>ftp&gt; logout: logout of the ftp session.</p> <p><b>Note: Please ensure that the FTP server is reachable by checking with ping command from debug prompt.</b></p>
<p><b>EXAMPLE</b></p>	<pre>(CLI-eng)# ftp 10.14.0.85 trango Password: ftp&gt;get zImage #####  Get operation successful with passive mode  ftp&gt;put linkloss.txt linkloss.txt #####</pre>

	<p>Put operation successful with passive mode</p> <p>ftp&gt;logout</p> <p>(CLI-config)#</p>
--	---

### guard\_time

<b>SYNTAX</b>	<p><i>guard_time</i></p> <p><i>guard_time</i> &lt;10-60&gt; seconds</p> <p>Default: 15 seconds.</p> <p>Configuration Storage: Yes</p> <p><i>guard_time</i> without any parameter will display the current guard time value in seconds.</p>
<b>DESCRIPTION</b>	<p>Guard time is only valid with failover feature enabled. Whenever a failover has occurred, the guard time will be started and within the guard time period, no additional failover is allowed.</p> <p>Guard time is used to enable the HW failover in the following condition:</p> <ol style="list-style-type: none"> <li>1. After election period is over.</li> <li>2. Whenever the link is established locally.</li> </ol>
<b>EXAMPLE</b>	<p>(CLI-eng)# guard_time</p> <p>Guard time: 15 seconds</p> <p>(CLI-eng)# guard_time 20</p> <p>Guard time: 20 seconds</p>

	SUCCESS
--	---------

### help / ?

<b>SYNTAX</b>	<p>?</p> <p>Default: N/A</p> <p>Configuration Storage: No</p> <p>? is a system-level command.</p>
<b>DESCRIPTION</b>	<p>Typing the ? command will display the list of commands in the current node with a one line description of the commands</p>
<b>EXAMPLE</b>	<p><i>(trango-config)#?</i></p> <p><i>&lt;Display the List of cmds&gt;</i></p>
<b>RELATED</b>	N/A

### httpd

<b>SYNTAX</b>	<p><i>httpd</i></p> <p><i>httpd &lt;on   off&gt;</i></p> <p>Default: <i>httpd ON.</i></p> <p>Configuration Storage: Yes</p>
---------------	---

	<p><i>httpd</i> without any parameter will display the current status for the web interface daemon</p> <p><i>httpd</i> is a system-level command.</p>
<b>DESCRIPTION</b>	<p>Turn on <i>httpd</i> server for web interface access.</p> <p>The web interface supports both secure (https) and normal (http) access.</p>

## ibm

<b>SYNTAX</b>	<p><i>ibm</i></p> <p><i>ibm enable &lt; on   off &gt;</i></p> <p><i>ibm ip &lt;ip_addr&gt; &lt;netmask&gt;</i></p> <p><i>ibm port &lt;1-2: ge1-ge2&gt;</i></p> <p><i>ibm tagging &lt;on off&gt;</i></p> <p><i>ibm vlanid &lt;1-4088&gt;</i></p> <p>Default: enable=ON, ip=172.16.1.1 or 172.16.1.2, netmask=255.255.255.0, vlanid=4085.</p> <p>Configuration Storage: Yes</p> <p><i>ibm</i> without any parameter will display the current IBM features parameters.</p>
<b>DESCRIPTION</b>	<p><i>ibm</i> is used to configure the In Band Management (IBM) channel to manage the system.</p> <p>Both IBM and the Out of Band Management (OBM) can be used together. The management VLAN ID can be configured based on the user requirement from 1-4088. The IP address for the IBM channel is independent of the OBM port on the IDU.</p> <p><i>ibm</i> can be used with tagging off by simply disabling the <i>ibm tagging</i> – This feature applies to AP-OMU-2 models only</p> <p>The 2 IP addresses need to be unique.</p>

## ipconfig

<b>SYNTAX</b>	<p><i>ipconfig</i></p> <p><i>ipconfig ip [ip_addr] [netmask]</i></p> <p><i>ipconfig gateway [default_gateway_ip]</i></p> <p>Default: IP=192.168.100.100, NETMASK=255.255.255.0, GATEWAY=192.168.100.100, REMOTE_IP= 0.0.0.0</p> <p>Configuration Storage: Yes</p> <p><i>ipconfig</i> without any parameter will display the current IP configuration and remote IP address.</p> <p><i>ipconfig</i> is a system-level command.</p>
<b>DESCRIPTION</b>	<p>This command is used to set IP address, subnet mask and default gateway for the management port of the system. The system MAC address can be displayed via this command. The change takes place effect immediately.</p> <p><i>Ipconfig ip:</i> Both IP and netmask parameters must be present.</p> <p><i>Ipconfig gateway:</i> Configure the default gateway IP. Valid for both Inband and Out-of-band port.</p>

## license

<b>SYNTAX</b>	<p><i>license</i>    <i>Display license enable status</i></p> <p><i>license_speed</i> &lt;1-2&gt; &lt;speedkey&gt;</p> <p><i>license_power</i> &lt;power key&gt;</p> <p>Default: N/A</p> <p>Configuration Storage: No</p>
---------------	---

<b>DESCRIPTION</b>	<p>License key command is used to set the license required for using higher speed (&gt; 111 Mbps) or higher transmit power on the radio. Speed license 1 enables speed up to 200Mbps and license 2 enables Max speed. The power license allows higher transmit powers for some frequencies and modulations. Please refer to the actual speed/modulation/channel_width combination for valid profiles.</p> <p>The license key is specific to each unit (management port Ethernet MAC address) and is not transferable. Please refer to valid speed profiles.</p>
--------------------	---

### link\_history

<b>SYNTAX</b>	<p><i>link_history</i></p> <p>Default: N/A</p> <p>Configuration Storage: No</p>
<b>DESCRIPTION</b>	<p>This command displays the link history and the link steady flag.</p> <p><i>Link history:</i> contains the number of link up/down occurred since the system bootup and this number does not get reset until the radio reboots.</p> <p><i>Link steady:</i> current status of link steady flag. Link steady set to 1 approximately 40 seconds after the link has established.</p>

### linktest

<b>SYNTAX</b>	<p><i>linktest &lt;iterations&gt;</i></p> <p>Iteration range from 1-99 seconds</p> <p>Default: default iteration = 1 second</p> <p>Configuration Storage: NO</p> <p><i>mse</i> without any parameter will display the current mse value for both Modem1 and Modem2</p>
---------------	--

<b>DESCRIPTION</b>	<p>Linktest command is used to test the current link status and can be used to monitor the link, based on the specified duration. CLI prompt will not be accessible while linktest is running</p> <p>The linktest shows the following in the output</p> <p>Lock: Radio Lock Status</p> <p>    1: if all modem locks are locked</p> <p>    0: if any lock indicator shows unlocked</p> <p>RSSI: The current RSSI value</p> <p>MSE: The current MSE value</p> <p>BER : The instantaneous BER value (1sec interval)</p>

### loglevel

<b>SYNTAX</b>	<p>loglevel [0-2]</p> <p>&lt;0: Setting, 1: Event, 2: Status&gt;Default: N/A</p> <p>Configuration Storage: Yes</p>
<b>DESCRIPTION</b>	<p>loglevel is used to set the appropriate logging for the system.</p> <p>This command is used to set required log levels for system logging. The log level needs to be set for each activity to be monitored. Once the loglevels are set, the logs can be monitored through the “syslog” command</p>

### loopback

<b>SYNTAX</b>	<i>loopback</i>
---------------	-----------------



	<p><i>loopback &lt;off  if  dig   rfl_gen   rf_refl  baseband &gt;</i></p> <p><i>loopback_auto</i></p> <p>Default: OFF</p> <p>Configuration Storage: Yes</p> <p><i>loopback</i> without any parameter will display the current status</p>
<b>DESCRIPTION</b>	<p>Activates one of the loopback modes for test purposes. Must be turned off by a command. The CLI is still active while the mode is on to allow monitoring of various parameters.</p> <p>During IF and digital loopback, the transmitter signal from the far end will still be present at the input to the IDU and may cause a poor result. Therefore, the odupower OFF on the remote end of may be required to eliminate any signal from the far end which may corrupt the result.</p> <p><i>loopback_auto</i> will automatically run <i>loopback if</i> and <i>loopback dig</i> on a far end radio, then restore the link. This allows troubleshooting the far end remotely using the ibm interface. All data ports are disabled while the loopback is running to prevent a traffic loop at the far end switch.</p> <p>All loopback modes will stop live traffic from passing across the link</p>

## model

<b>SYNTAX</b>	<p><i>model</i></p> <p>Default: N/A</p> <p>Configuration Storage: No</p>
<b>DESCRIPTION</b>	<p>Display current ODU/OMU model and serial ID.</p> <p>The following information are been displayed: ODU model, OMU model, ODU Serial ID, OMU Model, OMU Serial ID.</p> <p>There are Two OMU models AP-OMU-1 and AP-OMU-2 – Only difference between the two models is that the AP-OMU-1 is limited to In –Band Management using a VLAN, and</p>

	the AP-OMU-2 can be managed with either a VLAN or without a VLAN. The AP-OMU-2 replaces the AP-OMU-1.
<b>EXAMPLE</b>	<p><b>AP1 with HP1 ODU:</b></p> <pre>(CLI-config)# model OMU Model:      AP-OMU-1 OMU Serial ID:  1915805 ODU Model:      HP1-18-1010-A ODU Serial ID:  R13100475 Tx Freq Min:    17685 Tx Freq Max:    17985 Freq duplex:    1010.00 (MHz)</pre> <p><b>AP2 with HP2 ODU:</b></p> <pre>(CLI-config)# model OMU Model:      AP-OMU-1 OMU Serial ID:  8900006 ODU Model:      HP2-11-490-1A ODU Serial ID:  C 2010DEC02314 Tx Freq Min:    10700.00 Tx Freq Max:    10890.00 Freq duplex:    490.00 (MHz)</pre>

**mse**

<b>SYNTAX</b>	<p><i>Mse</i></p> <p><i>mse &lt;duration&gt;: duration range from 1-99 seconds</i></p> <p>Default: default duration = 1 second</p>
---------------	--

	<p>Configuration Storage: NO</p> <p><i>mse</i> without any parameter will display the current mse value for the received signal.</p>
<b>DESCRIPTION</b>	<p><i>mse</i> command is used to monitor the Mean Square Error (MSE) of the link received signal based on the specified duration. CLI prompt will not be accessible while linktest is running.</p>

### **odupower**

<b>SYNTAX</b>	<p><i>odupower</i></p> <p><i>odupower &lt; on  off &gt;</i></p> <p>Default: OFF</p> <p>Configuration Storage: Yes</p> <p><i>odupower</i> without any parameter will display the current status of ODU power .</p>
<b>DESCRIPTION</b>	<p>The command is used to Turn ON/OFF odupower.</p> <p>The ODU is powered from the IDU over the IF cable with -48VDC</p> <p>It is recommended to turn off the ODU power during initial installing of the ODU on the tower and other maintenance</p> <p>The response time for ODU power ON will vary depending upon the ODU model. It is longer for HP ODUs</p>

### **opmode**

<b>SYNTAX</b>	<p><i>opmode</i></p> <p><i>opmode &lt; on  off &gt;</i></p>
---------------	---

	<p>Default: OFF</p> <p>Configuration Storage: NO</p> <p><i>opmode</i> without any parameter will display the current status of ODU operation mode</p>
<b>DESCRIPTION</b>	<p>Opmode command is used to enable the transmitter on the ODU. Opmode settings are not persistent across reboot. See default_opmode command.</p> <p><i>freq</i> and <i>speed</i> settings are required to be set to a valid value <b>before</b> opmode can be turned ON.</p>

### passwd

<b>SYNTAX</b>	<p><i>passwd</i> &lt;new_password&gt; &lt;confirm_password&gt;</p> <p>Default: N/A. Default config node passwd is trango</p> <p>Configuration Storage: Yes</p> <p><i>passwd</i> is a system-level command.</p> <p>&lt;new_password&gt; must be at least 4 characters and no more than 10 characters. Spaces are not allowed.</p> <p>&lt;new_password&gt; and &lt;confirm_password&gt; must be identical for the new password to take effect</p>
<b>DESCRIPTION</b>	<p>Update the current password for entering “config-node”. The new password takes effect only after a <i>reboot</i> command or re-enter the “view-node” from debug prompt with <i>cli</i> command.</p>

### port

<b>SYNTAX</b>	<p><i>port eth</i> &lt;1-2&gt; <i>auto_negotiate</i> &lt;on   off&gt;</p> <p><i>port eth</i> &lt;1-2&gt; <i>duplex</i> &lt;half   full&gt;</p> <p><i>port eth</i> &lt;1-2&gt; <i>enable</i> &lt;on   off&gt;</p>
---------------	--

	<p><i>port eth &lt;1-2&gt; maxrate &lt;0-1000&gt;</i></p> <p><i>port eth &lt;1-2&gt; pause &lt;on  off&gt;</i></p> <p><i>port eth &lt;1-2&gt; priority &lt;0-7&gt;</i></p> <p><i>port eth &lt;1-2&gt; speed &lt;0-1000&gt;</i></p> <p>Default: see Table below</p> <p>Configuration Storage: YES</p> <table border="1" data-bbox="472 604 1045 1087"> <thead> <tr> <th>profile</th> <th>Ge1-copper</th> <th>Ge2-fiber</th> </tr> </thead> <tbody> <tr> <td>Enable</td> <td>On</td> <td>On</td> </tr> <tr> <td>Pause Frame</td> <td>Off</td> <td>Off</td> </tr> <tr> <td>Auto Nego</td> <td>On</td> <td>On</td> </tr> <tr> <td>Duplex</td> <td>Full</td> <td>Full</td> </tr> <tr> <td>Priority</td> <td>0</td> <td>0</td> </tr> <tr> <td>Speed</td> <td>1000</td> <td>1000</td> </tr> <tr> <td>Max Rate</td> <td>1000</td> <td>1000</td> </tr> </tbody> </table> <p><i>Default Port Settings</i></p>	profile	Ge1-copper	Ge2-fiber	Enable	On	On	Pause Frame	Off	Off	Auto Nego	On	On	Duplex	Full	Full	Priority	0	0	Speed	1000	1000	Max Rate	1000	1000
profile	Ge1-copper	Ge2-fiber																							
Enable	On	On																							
Pause Frame	Off	Off																							
Auto Nego	On	On																							
Duplex	Full	Full																							
Priority	0	0																							
Speed	1000	1000																							
Max Rate	1000	1000																							
<b>DESCRIPTION</b>	<p>This command is used to set Ethernet port settings. Ethernet: auto negotiation, enable/disable, speed, priority, pause frame, duplex and max rate.</p> <p>Speed/Duplex/Auto Negotiate is fixed for ge2 which is GigE Fiber ports and these setting are not configurable</p>																								

**power**

<b>SYNTAX</b>	<p><i>power</i></p> <p><i>power &lt; 0-30 &gt;</i></p> <p>Default: 10 dBm</p> <p>Configuration Storage: Yes</p>
---------------	---

	<i>opmode</i> without any parameter will display the current status of ODU transmit power level
<b>DESCRIPTION</b>	<p>Power command is used to set the ODU transmit power level. The maximum level is dependent upon the modulation and ODU model.</p> <p>Ensure that the power does not exceed the rating for the modulation being used or signal distortion will occur</p> <p>The user cannot change power when ATPC is ON.</p>

### prompt

<b>SYNTAX</b>	<p><i>prompt</i> &lt;<i>prompt_str</i>&gt;</p> <p>Default: CLI</p> <p>Configuration Storage: Yes</p> <p><i>prompt</i> is a system-level command.</p>
<b>DESCRIPTION</b>	<p>Prompt command is used to update the CLI prompt with more descriptive name of the system. Default prompts are &lt;CLI-view&gt;, &lt;CLI-config&gt;. The user may update to a string that is more meaningful.</p>

### qos

<b>SYNTAX</b>	<p><i>qos mode</i> &lt;0/1&gt;</p> <p><i>qos dscp_weight</i> &lt;0-7(priority)&gt; &lt;1-16(weight)&gt;</p> <p><i>qos_info</i> &lt;1/ 2&gt;</p> <p>Default: CLI</p>
---------------	---

	<p>Configuration Storage: Yes</p> <p><i>qos</i> is a system-level command.</p>
<b>DESCRIPTION</b>	<p>The <i>qos mode</i> command allows selection of strict or weighted quality of service. In strict mode, all packets must be cleared from the highest priority queue before any lower queues are forwarded. In weighted mode, some packets from all queues will be forwarded, but queues with higher weighted priorities will be serviced more often.</p> <p>The <i>qos_dscp_weight</i> command allows assigning weights to priority levels for layer 2 tagged traffic. The web based DSCP mapping will map an individual code point into a priority level, and then to a specific queue. Priority levels are assigned to specific queues by the <i>cos</i> command.</p>

### reboot

<b>SYNTAX</b>	<p><i>reboot</i></p> <p>Default: N/A</p> <p>Configuration Storage: No</p> <p><i>reboot</i> is a system-level command.</p>
<b>DESCRIPTION</b>	<p>Reboots entire system including datapath. No configuration changes after the system reboot.</p>

### reload

<b>SYNTAX</b>	<p><i>reload &lt;1-240&gt;</i></p> <p><i>reload cancel</i></p> <p>Default: N/A</p>
---------------	--

	<p>Configuration Storage: No</p> <p><i>reload</i> is a system-level command.</p>
<b>DESCRIPTION</b>	<p>Reboots the radio and reloads the saved configuration after a user set timer (from 1 to 240 minutes) expires. This allows the user to make changes to the system without worrying about permanently losing the connection to the far end. If the user loses connection while running tests or making changes, the unit will reboot itself and restore the last known good configuration and the link will be re-established.</p> <p><i>reload cancel</i> will cancel the pending reload.</p>

### remark

<b>SYNTAX</b>	<p><i>remark</i></p> <p><i>remark [system_remark]</i></p> <p>Default: Remark=Trango ApexPlus</p> <p>Configuration Storage: Yes</p>
<b>DESCRIPTION</b>	<p>Remark of the system typically used for identification purposes.</p> <p>Device string is used to display the device name on the top of the row for all the device-level parameters.</p>

### reset

<b>SYNTAX</b>	<p><i>reset config</i></p> <p><i>reset ipconfig</i></p> <p><i>reset license_key</i></p>
---------------	---



	<p>Default: N/A</p> <p>Configuration Storage: No</p> <p><i>reset</i> is a system-level command.</p>
<b>DESCRIPTION</b>	<p><i>reset config</i>: Restore all factory default configuration setting including resetting password for system login, CLI config node, Web interface login. Excluding license key and IP configuration.</p> <p>A reboot of the system is required for the command to take effect.</p> <p><i>reset ipconfig</i>: Reset only the IP configuration to default. Reboot required to make the reset IP configuration take effect.</p> <p><i>reset license_key</i>: Remove up to 5 license keys.</p>

## rps

<b>SYNTAX</b>	<p><i>rps &lt; on   off &gt;</i></p> <p>Default: OFF</p> <p>Configuration Storage: Yes</p> <p><i>rps</i> without any parameter will display the current status of Rapid Port Shutdown feature status.</p>
<b>DESCRIPTION</b>	<p>This command is used to configure Rapid Port Shutdown (RPS) functionality. The RPS setting needs to be the same on both side of the link for proper operation.</p> <p>If the RPS is enabled the data ports (GigE) on both side of the link are immediately shutdown in the event of a link loss in order to provide a fast trigger mechanism to the external routers and switches, which will reroute the traffic.</p> <p>RPS feature also provide automatic port up after the link is restored. To ensure port up/down due to unstable link. The RPS port up will only activate after detecting a good link with duration of minimum of 40 seconds to 1 minute.</p> <p><b>Note:</b> RPS should be disabled prior to enabling ACM, then re-enabled after the link is</p>

	<p>established with ACM active to prevent inadvertent disconnection of the Ethernet port and loss of management.</p> <p><b>Note:</b> refer to <i>link_history</i> command to check for <i>link_steady</i> status. RPS will only take effect if the <i>link_steady</i> is 1.</p>
<b>RELATED</b>	Sysinfo

### rsi

<b>SYNTAX</b>	<p><i>rsi &lt;iteration&gt;</i></p> <p>Iteration range from 1-99 seconds</p> <p>Default: default iteration = 1 second</p> <p>Configuration Storage: NO</p> <p><i>rsi</i> without any parameter will display the current mse value</p>
<b>DESCRIPTION</b>	<p><i>rsi</i> command is used to monitor the instantaneous receive signal level (RSL). It can be used to monitor the stability of the RSL when used in an iterative manner.</p> <p>CLI prompt will not be accessible while <i>rsi</i> command is running.</p> <p>RSSI value range is between -90 and -20</p>

### show

<b>SYNTAX</b>	<p><i>show history</i></p> <p><i>show loopback_auto</i></p> <p><i>show passwords</i></p> <p>Default: N/Q</p> <p>Configuration Storage: No</p>
---------------	---

<b>DESCRIPTION</b>	<p><i>show history</i> will display the last 20 commands entered to allow the user to see any changes that were made.</p> <p><i>show loopback_auto</i> will display the result of the loopback auto command last executed.</p> <p><i>show passwords</i> will display the passwords for view, config and snmp. This command is only available from the config node.</p>

### siglevel

<b>SYNTAX</b>	<p><i>siglevel</i></p> <p>Default: N/Q</p> <p>Configuration Storage: No</p> <p><i>Siglevel</i> will display the signal level related parameters and is used as a debugging tool.</p>
<b>DESCRIPTION</b>	<p>This command is used to assist debugging any signal level related issue.</p> <p><b>OMU RSSI:</b> OMU rssi at the N-Connector – Nominal is -8 to -14 dBm Normalized MSE/Radial MSE: <b>Norm-MSE = Radial MSE</b> phase noise residue is minimal <b>Norm-MSE &gt; Radial MSE</b> there is some amplitude noise (AM distortion) <b>Norm-MSE &lt; Radial MSE</b> phase noise residue exist, that the PLL did not fully correct Uncorrected Block: Errors reported by modem when passing traffics.</p>
<b>EXAMPLE</b>	<pre>(trango-view)# siglevel OMU RSSI:          -17 Normalized MSE:    -313 Radial MSE:        -306 Uncorrect Block:   0 Alarm:             0x0000 RPS Alarm:         0x00 Tx measure:        0x00</pre>

## smart\_mode

<b>SYNTAX</b>	<p><i>smart_mode</i></p> <p>Default: On</p> <p>Configuration Storage: Yes</p> <p><i>smart_mode</i> without any parameter will display the current status of smart_mode</p>
<b>DESCRIPTION</b>	<p>Smart mode uses VLAN tags internally to map GE1 on Side A to GE1 on Side B , and GE2 on Side A to GE2 on Side B. If Smart mode is disabled, the traffic will appear at all ports on the receiving end. This is useful for media conversion between copper and fiber ports.</p> <p>Care should be taken to avoid creating loops. Smart mode is designed for cases where only one traffic port is used on each end of the link.</p> <p>Smart mode must be enabled or disabled on both ends for proper operation.</p> <p>This configuration require a config save and reboot commands to take effect.</p>
<b>EXAMPLE</b>	<pre>(CLI-config)# smart_mode  Smart mode:      on  (CLI-eng)#      smart_mode off  Smart mode:      off  SUCCESS</pre>

## snmpd

<b>SYNTAX</b>	<p><i>snmpd</i></p> <p><i>snmpd</i> &lt;on   off&gt;</p> <p>Default: ON</p> <p>Configuration Storage: No. Always ON at system bootup.</p>
---------------	---

	<i>snmpd</i> without any parameter will display the current status for the tftpd daemon
<b>DESCRIPTION</b>	Turn on/off snmpd agent on the radio. Must be on to perform any SNMP get/set.
<b>EXAMPLE</b>	To turn snmpd off <pre>(trango-config)# snmpd off</pre> <pre>snmpd: off</pre> <pre>SUCCESS</pre>
<b>RELATED</b>	<i>Ipconfig, snmptrap, trapip</i>

## speed

<b>SYNTAX</b>	<p><i>speed</i> &lt;bandwidth&gt; &lt;modulation&gt;</p> <p>&lt;bandwidth&gt;: 4, 5, 7, 8, 10, 12, 14, 20, 25, 28, 30, 40, 50, 56, 80</p> <p>&lt;modulation&gt;: qpsk, qam16, qam32, qam64, qam128, qam256</p> <p>Default: bandwidth 20, QAM128</p> <p>Configuration Storage: Yes</p> <p><i>speed</i> without any parameter will display the current speed setting</p>
<b>DESCRIPTION</b>	<p>Load the corresponding the modem binary file and configure Tx and Rx bandpass filters.</p> <p>The <i>speed</i> command will also configure the standby radio based on the <i>failover</i> configuration being on.</p> <p>Binaries selection for the speed command is based on the following configuration settings: acm enable, modulation and bandwidth. A change in any of these settings will require a re-load of the binary files using the <i>speed</i> command.</p>

## status

<b>SYNTAX</b>	<p><i>status modem</i></p> <p><i>status pll</i></p> <p><i>status port</i></p> <p><i>status tdm1(future)</i></p> <p><i>status clear</i></p> <p>Default: N/A</p> <p>Configuration Storage: No</p> <p><i>status</i> is a system-level command.</p>
<b>DESCRIPTION</b>	<p><i>status modem</i>: display modem link status. MSE, RSSI, BER, FER</p> <p><i>status pll</i>: display ODU / IDU pll lock status.</p> <p><i>status port</i>: display Ethernet counters for each ports, RF counters and port utilizations.</p> <p><i>status tdm</i>: display T1/E1 counters and error status. (future)</p> <p><i>status clear</i>: clear all Ethernet, RF, TDM counters and port utilization.</p>

## sync

<b>SYNTAX</b>	<p><i>sync</i></p> <p>Default: N/A</p> <p>Configuration Storage: N/A</p>
---------------	--

	<p><i>sync</i> without any parameter will perform synchronization procedure between Active and Standby unit</p> <p><i>sync</i> command only allowed to be initiated on Active unit.</p>
<b>DESCRIPTION</b>	<p><i>sync</i> is used to perform synchronization procedure to sync up configuration parameters between Active and Standby units. There are some parameters which are independent of utype and therefore, will not be synchronized with this command. The following commands are the ones that do NOT get synchronized on the Standby unit:</p> <p>ibm, ipconfig, license key, loopback mode, opmode, tftpd and traps.</p>
<b>EXAMPLE</b>	<p><i>(CLI-config)# sync</i></p> <p><i>Sync Status:                    Synchronized</i></p>

### sync\_status

<b>SYNTAX</b>	<p><i>sync_status</i></p> <p>Default: N/A</p> <p>Configuration Storage: N/A</p> <p><i>sync_status</i> without any parameter will display synchronization status</p>
<b>DESCRIPTION</b>	<p><i>sync_status</i> is used to display the current synchronization status between Active and Standby units. This command is not meaningful if 1+1 HSB is not being used.</p> <p>The following parameters will not be synchronized.</p> <p>alarm, cableloss, fanctrl, ibm, ipconfig, license key, loopback mode, opmode, tftpd and traps.</p>

<b>EXAMPLE</b>	<pre>(CLI-config)# sync_status</pre> <p>Sync Status:            Synchronized</p>
----------------	--

### sysinfo

<b>SYNTAX</b>	<pre>sysinfo</pre> <pre>sysinfo &lt;0-6&gt;</pre> <p>Default: N/A</p> <p>Configuration Storage: No</p> <p><i>sysinfo</i> without any parameter will display the current OMU and ODU configuration parameters.</p> <p><i>sysinfo</i> takes a parameter for information category: 0=version info, 1=Management, 2=Radio Config, 3= System Config , 4=Ethernet 5=ACM, 6=threshold settings. <i>sysinfo</i> is a system-level command.</p>
<b>DESCRIPTION</b>	<p>View the current configuration status of the local side IDU and ODU. To select a subset of the entire system info, add the argument 0 through 6 after the <i>sysinfo</i> command</p>

### syslog

<b>SYNTAX</b>	<pre>syslog</pre> <pre>syslog [0-2]</pre> <pre>syslog clear</pre> <pre>syslog export</pre> <p>Default: 0: SET, 1: EVENT</p> <p>Configuration Storage: Yes</p> <p><i>syslog</i> without any parameter will display all the system log message for up to 3000 lines.</p>
---------------	--



	<p><i>syslog</i> takes a parameter for log level: 0=SET, 1=EVENT, 2=STAT</p> <p><i>syslog export</i>, export the syslog to a syslog.txt file which can be tftp by customer.</p> <p><i>syslog</i> is a system-level command.</p>
<b>DESCRIPTION</b>	<p><i>syslog</i>: will display all the system log entries that have been recorded since the boot up.</p> <p><i>syslog clear</i>: Clear all syslog. Only 3000 log entries will be captured and will wrap around when overflows.</p>

### targetrssi

<b>SYNTAX</b>	<p><i>targetrssi</i></p> <p><i>targetrssi</i> &lt; -30 - 80 &gt;</p> <p>Default: -40</p> <p>Configuration Storage: YES</p> <p><i>targetrssi</i> without any parameter will display the targetrssi of the ODU</p>
<b>DESCRIPTION</b>	<p>Configure the target RSSI level that the ATPC and ODU gain control will try to maintain. The number should be 2-3 dB below the expected RSSI based on path calculations.</p>

### tdm

<b>SYNTAX</b>	<p><i>tdm</i></p> <p>Default: N/A</p> <p>Configuration Storage: No</p>
<b>DESCRIPTION</b>	<p>Displays TDM port mode and coding</p>

	<p>For E1: GDB3</p> <p>For T1: HDB3</p>
--	---

### telnetd

<b>SYNTAX</b>	<p><i>telnetd</i></p> <p><i>telnetd</i> &lt;on   off&gt;</p> <p>Default: <i>telnetd OFF</i>.</p> <p>Configuration Storage: Yes</p> <p><i>telnetd</i> without any parameter will display the current status for the telnetd daemon</p> <p><i>telnetd</i> is a system-level command.</p>
<b>DESCRIPTION</b>	Linux system command to start the telnetd daemon

### temp

<b>SYNTAX</b>	<p><i>temp</i></p> <p>Default: N/A</p> <p>Configuration Storage: No</p> <p><i>temp</i> without any parameter will display the current OMU and ODU temperatures. Updated every 15 seconds</p> <p><i>temp</i> is a system-level command.</p> <p>Display of this status is through shared memory.</p>
---------------	--

<b>DESCRIPTION</b>	View the current temperatures of OMU and ODU. The temperature reported is the temperature inside the unit in degrees Celcius

### tftpd

<b>SYNTAX</b>	<p><i>tftpd</i></p> <p><i>tftpd &lt;on   off&gt;</i></p> <p>Default: <i>tftpd OFF</i>.</p> <p>Configuration Storage: Yes</p> <p><i>tftpd</i> without any parameter will display the current status for the tftpd daemon</p> <p><i>tftpd</i> is a system-level command.</p>
<b>DESCRIPTION</b>	Turn on the tftp server. Used to transfer diagnostic file, configuration file and software images during upgrades.

### threshold

<b>SYNTAX</b>	<p><i>threshold</i></p> <p><i>threshold action &lt;0-8(threshold)&gt; &lt;0-3(action)&gt;</i></p> <p><i>threshold value &lt;0-7(threshold)&gt; &lt;min   max&gt; &lt;value&gt;</i></p> <p>Defaults: see the table below.</p> <table border="1" data-bbox="522 1654 1289 1892"> <thead> <tr> <th>param</th> <th>min</th> <th>max</th> <th>Action</th> </tr> </thead> <tbody> <tr> <td>RSSI</td> <td>-85</td> <td>-20</td> <td>none</td> </tr> <tr> <td>MSE</td> <td>-45</td> <td>-15</td> <td>none</td> </tr> <tr> <td>BER</td> <td>0.00E+0</td> <td>1.00E-4</td> <td>none</td> </tr> </tbody> </table>	param	min	max	Action	RSSI	-85	-20	none	MSE	-45	-15	none	BER	0.00E+0	1.00E-4	none
param	min	max	Action														
RSSI	-85	-20	none														
MSE	-45	-15	none														
BER	0.00E+0	1.00E-4	none														

FER	0.00E+0	1.00E-4	none
OMU temp	-10	55	none
ODU temp	-40	58	none
In port util	0.0	100.0	none
Out port util	0.0	100.0	none
Link Down	N/A	N/A	none

Configuration Storage: Yes

*threshold* without any parameter will display the current status for threshold setting information. *threshold value* assigns min and max limits for each of the following parameters (except Link Down which has no min or max):

Threshold Parameter Mapping

- 0 RSSI
- 1 MSE
- 2 BER
- 3 FER
- 4 OMU Temp (deg C)
- 5 ODU Temp (deg C)
- 6 In Port Utilization (percent of max available)
- 7 Out Port Utilization (percent of max available)
- 8 Link Down

Threshold action assigns actions to be taken if the actual parameter crosses the min or max limit. Valid actions are:

- 0 none (no action)
- 1 snmp trap is generated and sent to all trap IP Addresses that are enabled
- 2 switchover to the Hot Standby Link is forced.
- 3 RPS – Rapid Port Shutdown of the datapath physical interfaces (PHY) is made on both ends of the link to allow layer 2 path switching using STP or RSTP protocols running on a connected switch.

*threshold* is a device-level command.

*threshold* command is used to set rules for monitoring the system. Whenever the threshold exceeds the programmed values the desired action is set.

The utilization rate is expressed as percentage of the current max speed based on the modulation.

## trap

<b>SYNTAX</b>	<p><i>trap</i></p> <p><i>trap enable &lt;trap #&gt; &lt;on   off&gt;</i></p> <p><i>trap ip &lt;trap #&gt; &lt;ip_addr&gt;</i></p> <p>Default: see below</p> <table border="1"><thead><tr><th>trap #</th><th>IP</th><th>enable</th></tr></thead><tbody><tr><td>Trap 1 manager</td><td>0.0.0.0</td><td>OFF</td></tr><tr><td>Trap 2 manager</td><td>0.0.0.0</td><td>OFF</td></tr><tr><td>Trap 3 manager</td><td>0.0.0.0</td><td>OFF</td></tr><tr><td>Trap 4 manager</td><td>0.0.0.0</td><td>OFF</td></tr><tr><td>Trap 5 manager</td><td>0.0.0.0</td><td>OFF</td></tr></tbody></table> <p>Configuration Storage: Yes</p> <p><i>trap</i> without any parameter will display the current status for the snmptrap information</p> <p><i>trap</i> is a system-level command.</p>	trap #	IP	enable	Trap 1 manager	0.0.0.0	OFF	Trap 2 manager	0.0.0.0	OFF	Trap 3 manager	0.0.0.0	OFF	Trap 4 manager	0.0.0.0	OFF	Trap 5 manager	0.0.0.0	OFF
trap #	IP	enable																	
Trap 1 manager	0.0.0.0	OFF																	
Trap 2 manager	0.0.0.0	OFF																	
Trap 3 manager	0.0.0.0	OFF																	
Trap 4 manager	0.0.0.0	OFF																	
Trap 5 manager	0.0.0.0	OFF																	
<b>DESCRIPTION</b>	<p><i>trap</i> is used to enable and configure traps and the IP address which they will be sent to</p>																		

## uptime

<b>SYNTAX</b>	<p><i>uptime</i></p>
<b>DEFAULT VALUE</b>	<p>N/A</p>
<b>DESCRIPTION</b>	<p>Uptime is used to display how long the system has been running, since the last</p>

	<p>reboot/power cycle.</p> <p>It shows the current time and uptime.</p>
<b>EXAMPLE</b>	<p>To display current uptime</p> <p><i>(trango-config)# uptime</i></p> <p><i>20:45:58 up 1:49, load average</i></p>
<b>RELATED</b>	Date

## utype

<b>SYNTAX</b>	<p><i>utype</i></p> <p>Default: N/A</p> <p>Configuration Storage: N/A</p> <p><i>utype</i> without any parameter will display current utype and other related status.</p>
<b>DESCRIPTION</b>	<p><i>Utype</i> command will display unit's current utype, remote unit status, election period status and sync status.</p> <p><u>Current utype</u>: No utype, Active, or Standby</p> <p><u>Remote unit status</u>: no detection, detecting an active, or detecting a standby</p> <p><u>Election Period</u>: yes (during election period), no (not in election period)</p> <p><u>Sync Status</u>: Current synchronization status. Synchronized or Not synchronized.</p>
<b>EXAMPLE</b>	<p><i>(CLI-config)# utype</i></p> <p><i>Current utype: active</i></p>

	<p><i>Remote unit status: detecting a standby</i></p> <p><i>Election Period: no</i></p> <p><i>Sync Status: Synchronized</i></p>
--	---

### **utype\_switch**

<b>SYNTAX</b>	<p><i>utype_switch</i></p> <p>Default: N/A</p> <p>Configuration Storage: N/A</p> <p><i>utype_switch</i> does not take any input parameter. Will perform utype switch from Active to Standby.</p> <p>This command only allowed on the Active unit. Can NOT be initiated on Standby unit</p>
<b>DESCRIPTION</b>	<p><i>utype_switch</i> manually switch the Active to the Standby unit by forcing a coordinated swap of the utypes between the current active and current standby units.</p> <p>This command is mainly used for image upgrades. During the image upgrades, the standby unit can be upgraded first and when done, perform <b><i>utype_switch</i></b> to make the current Active unit Standby to continue the upgrade process.</p>
<b>EXAMPLE</b>	<p><i>(CLI-config)# utype</i></p> <p><i>Current utype: active</i></p> <p><i>Remote unit status: detecting a standby</i></p> <p><i>Election Period: no</i></p> <p><i>Sync Status: Synchronized</i></p>

## version

<b>SYNTAX</b>	<i>version</i>
<b>DEFAULT VALUE</b>	N/A
<b>DESCRIPTION</b>	Version command is used to display the current /previous software images on the radio. The system is capable of have multiple images.
<b>RELATED</b>	bootimage

## voltage

<b>SYNTAX</b>	<i>voltage</i>  Default: N/A  Configuration Storage: No  <i>voltage</i> without any parameter will display the current status for the OMU power voltage at different source  <i>voltage</i> is a system-level command.
<b>DESCRIPTION</b>	Query the voltage level at different power source on OMU. The following power source are being look at: V1.25: V2.5: V3.3: V5.0:

## web\_refresh\_rate

<b>SYNTAX</b>	<i>web_refresh_rate</i>  <i>web_refresh_rate</i> <2-300>  Default: 0 = no refresh
---------------	---



	Configuration Storage: Yes
<b>DESCRIPTION</b>	<i>web_refresh_rate</i> without any argument will display the current refresh rate of the web interface in seconds. If the argument is 0, web refresh is turned off and the user must manually refresh the web page from the browser program. If the rate is 2 to 300 seconds, then the web pages will automatically update at the interval given.

## Appendix B – Product Specifications

### Dimensions and Weight

Parameter	Specification
Size	AP1 Models: 10.5 x 10.5 x 6 in AP2 Models: 10.5 x 10.5 x 5.5 in
Weight	AP1 Models: 15.1 lbs/6.85 kg AP2 Models: 13.2 lbs/6 kg

### Environmental

Parameter	Specification
Operating Temperature Range	-40 deg C to +65 deg C - Functional -40 deg C to +55 deg C - Spec Compliant
Storage Temperature	-40 deg C to +75 deg C
Humidity	100% Condensing
Water resistance	IP65 per EN 60529
Salt-Spray	Per IEC/EN-60950-22

### Emissions

Parameter	Specification
ETSI Conducted Emissions	EN 55022 (2006) Class "A"
FCC Conducted Emissions	FCC 15.107 (a) Class "A"
ETSI Radiated Emissions	EN 55022 (2006) Class "A"
FCC Radiated Emissions	FCC 15.109 (a) Class "A"
Salt-Spray	Per IEC/EN-60950-22

## Reliability

Parameter	Specification
MTBF	> 18 years

## Electromagnetic Compliance

Parameter	Specification
EMC test methods	EN 301 489-1 V1.8 (2008-04) EN 301 489-4 V1.4.1 (2009-02)
Power Line Harmonics	EN 61000-3-2:2006
Power Line Fluctuations/Flicker	EN 61000-3-3:2008
Electrostatic Discharge (ESD)	EN 61000-4-2:2009
Radiated RF immunity	EN 61000 -4-3:2004, Radiated at 3 V/m
Electrical Fast transients	EN 61000-4-4:2004
Power Line Surge Immunity	EN 61000-4-5:2006
Powerline RF conducted immunity	EN 61000-4-6:2005
Voltage Dips and Short Interruptions	EN 61000-1-4-11:2004

## Wireless Compliance

Parameter	Specification
FCC	CFR47 Part 101 CFR47 Part 15 Class A unintentional radiator
Canada	SRSP-xx
Europe (Harmonized)	EN 302 217-2-1 EN 302 217-2-2
Australia	RALI FX5
New Zealand	PIB22

## Wireless Parameters

Parameter	Specification
Frequency Range	6-40 GHz
Channel Sizes Supported	3.5, 5, 7, 8.33, 10 , 12.5, 13.75, 14, 20, 25, 27.5, 28, 30, 40, 50, 55, 56, 80 MHz
Fixed Modulation Set Levels	QAM256, QAM128, QAM64, QAM32, QAM16, QPSK
Transmitter Power Accuracy	+/- 2 dB
Transmitter Frequency Accuracy	+/- 7 ppm
Transmitter Center Frequency Synthesizer step size	250 kHz
Transmitter Output Power (Muted )	< -50 dBm
Transmitter Output Return Loss	> 10 dB
Adaptive Modulation Set Levels	QAM256, QAM128, QAM64, QAM32, QAM16
Adaptive Modulation Type	Error Free, Hitless through each transition
Adaptive Modulation Transitions Thresholds	User Settable
Automatic Transmitter Power Control	> 15 dB range, user configurable step size and max power limit

## Transmitter Power

Modulation	Maximum Transmit Power by Frequency (dBm)					
	6, 7, 8	10	11	13,15	18-26	28-40
QPSK	30	26.5	28	26	25	23
16QAM	28	22.5	26	22/25*	22/23*	21
32QAM	28	22.5	26	22/25*	22/23*	21
64QAM	25	20.5	22/25*	21/24*	20/22*	17
128QAM	25	20.5	22/25*	21/24*	20/22*	17
256QAM	24	18.5	21/24*	20/23*	19/21*	16

\*With high power license key (AP-KEY-3) on AP1 models only

0

## Radio Sensitivity

Channel Width (MHz)	Symbol Rate (Msps)	Receive Sensitivity (dBm) 6-26 GHz					
		QPSK	QAM 16	QAM 32	QAM 64	QAM 128	QAM 256
3.5	3	-96.6	-90.4	-86.4	-84	-80.9	-77.9
5	4.3	-94.4	-88.8	-84.8	-82.1	-79.0	-76.0
7	5.6	-93.3	-87.7	-83.7	-81.3	-78.2	-75.2
8.33	7.2	-92.7	-86.5	-82.5	-80.3	-77.5	-74.4
10	8.32	-92.2	-86.0	-82.0	-79.6	-76.5	-73.5
12.5	10.8	-91.3	-85.4	-81.1	-78.7	-75.4	-72.4
14	12.2	-90.5	-84.3	-80.3	-77.9	-74.8	-71.8
20	17.42	-89.0	-82.8	-78.8	-76.4	-73.3	-70.3
25	21.8	-88.1	-82.0	-78	-75.4	-72.3	-69.3
28/30	26	-87.3	-81.1	-77.1	-74.7	-71.6	-68.6
40	34.83	-86.0	-79.8	-75.8	-73.4	-70.3	-67.3
50	43	-85.1	-78.9	-74.9	-72.5	-69.4	-66.4
55/56/80	50	-84.5	-78.3	-74.3	-71.9	-68.8	-65.8*

\*-63.8 dBm when set to speed 80 qam256

Channel Width (MHz)	Symbol Rate (Msps)	Receive Sensitivity (dBm) 28-40 GHz					
		QPSK	QAM 16	QAM 32	QAM 64	QAM 128	QAM 256
3.5	3	-93.6	-87.4	-83.4	-81.0	-77.9	-74.9
5	4.3	-91.4	-85.8	-81.8	-79.1	-76.0	-73.0
7	5.6	-90.9	-84.7	-80.7	-78.3	-75.2	-72.2
8.33	7.2	-89.7	-83.5	-79.5	-77.3	-74.5	-71.4
10	8.32	-89.2	-83.0	-79.0	-76.6	-73.5	-70.5
12.5	10.8	-88.3	-82.4	-78.1	-75.7	-72.4	-69.4
14	12.2	-87.5	-81.3	-77.3	-74.9	-71.8	-68.8
20	17.42	-86.0	-79.8	-75.8	-73.4	-70.3	-67.3
25	21.8	-85.1	-79.0	-75	-72.4	-69.3	-66.3
28/30	26	-84.4	-78.1	-74.1	-71.7	-68.6	-65.6
40	34.83	-83.0	-76.8	-72.8	-70.4	-67.3	-64.3
50	43	-82.1	-75.9	-71.9	-69.5	-66.4	-63.4
55/56/80	50	-81.5	-75.3	-71.3	-68.9	-65.8	-62.8**

\*\* -60.8 dBm when set to speed 80 qam256

## 1+1 Hot Standby Link Protection

Parameter	Specification
Failover Time	150 mSec typical
Guard Time	User configurable 10 to 60 seconds

## Power

Parameter	Specification
Input Voltage Range (Direct)	-40 to -72 VDC
Input Voltage Range (PoE)	-43 to -50 VDC (At PoE-GigE-48 Power input)
Power Consumption	AP1: Typical 75 Watts AP2: Typical 50 Watts

## User Interfaces

Description	Specification
Ethernet Traffic Ports and/or In Band Management (IBM)	ETH1: RJ45 - 10/100/1000BaseT ETH2: SFP - 1000BaseT for SFP Module: SFP-GigE-C (1000BaseT) SFP-GigE-S (1000BaseLX Single Mode Fiber) SFP-GigE-M (1000BaseLX Multimode Fiber)
Out of Band Management (OBM)	RJ45- 10/100BaseT
Direct Power	2 Position Latching screw terminal Block
Console/Craft Port	Circular 8 pin connector (requires CBLDAT-4)
1+1 Redundancy Cable	Circular 8 pin connector (requires CBLDAT-RIU4)
RSSI Alignment	BNC-Female (CBLDAT-RSSI recommended)
Reset IP/Config	Momentary Push Button
T1/E1	RJ45 – Multiplexed with Management Port On PoE-GigE-48
Antenna	Slip-Fit Circular Waveguide – For compatible antennas, combiners and remote mounts consult Trango

## Ethernet Parameters

Parameter	Specification
Packet Size	64-9600 Bytes , IPV4, IPV6
Max Capacity	L1: 414 Mbps L2: 375 Mbps
Data Latency	< 100 uS for 64 byte packets, Max capacity (per RFC2544 store and forward)
QoS	802.1p Port Prioritization Port mapping to isolate ports VLAN Priority for tagged packets: 4 Classes of Service Bandwidth Shaping per port (Ingress Rate limiting)
RSTP	Rapid Port Shutdown both ends of link within 50 mSec of link drop

## T1/E1 Parameters

Parameter	Specification
Clock Source	External
T1 Compliance	T/O 1002-1993 ITU-T.G824 GR-499-CORE
E1 Compliance	ITU-T G.703 ITU-T G.823

## Appendix C – Cable Wiring

This appendix shows the wiring of the various interfaces on the ApexPlus unit.

### Ethernet Cabling

The Figures below show the cable pin-outs for straight-through and cross-over Ethernet cables. The images below conform to EIA/TIA industry standard for 568 A and B.

For ApexPlus, the cables should all be straight through cables wired to EIA 568A as shown below. All cables carrying -48VDC + Ethernet **MUST** be shielded Twisted Pair (STP) cables. Crossover cables should not be used.

If the first and second pins are orange, the cable is 568B. If the first and second pins are green, the cable is 568A (Figure C-2).

If one end of the cable is A and the other end is B it is a cross-over cable.

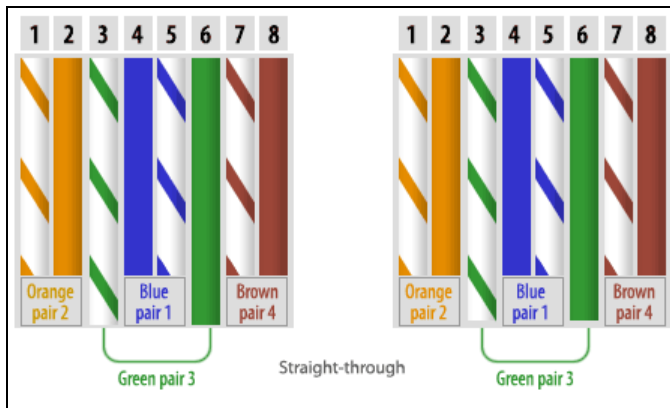

Figure 40 EIA/TIA 568A Straight through

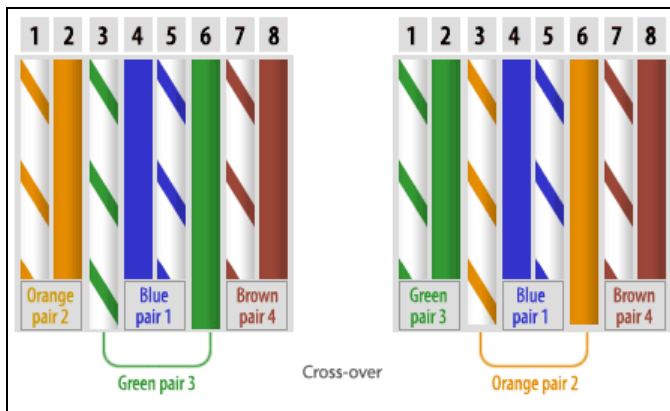
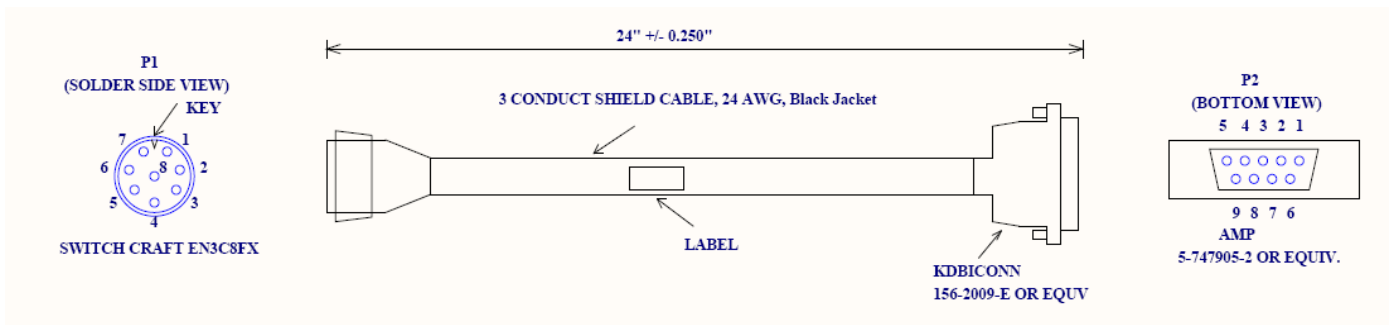

Figure 41 EIA/TIA 568B Cross-Over



## Console Port Cabling

The Interface cable to connect the ApexPlus to a standard Serial port DB9 connector is shown below. The cable can be purchased from Trango.



P1	P2
1, DRAIN	DRAIN, CHASSIS, 5
2	2
4	3

Figure 42: ApexPlus Serial Cable Pin-Out

## Appendix D – MIB OID Listing

### MIB-II System

Object ID	Name	Type	Access	Range Limit	Default Value
.1.3.6.1.2.1.1.1.0	sysDescr	DisplayString	RO	N/A	Spider-1.0
.1.3.6.1.2.1.1.2.0	sysObjectID	OID	RO	N/A	.1.3.6.1.4.1.5454.1.90
.1.3.6.1.2.1.1.3.0	sysUpTime	TimeTicks	RO	N/A	N/A
.1.3.6.1.2.1.1.4.0	sysContact	DisplayString	RO	N/A	Tech Support
.1.3.6.1.2.1.1.5.0	sysName	DisplayString	RO	N/A	Administrator
.1.3.6.1.2.1.1.6.0	sysLocation	DisplayString	RO	N/A	USA

### Trango

Object ID	Name	Type	Access	Range Limit	Default Value
.1.3.6.1.4.1.5454.1.90.1.1.1	sysFPGAVer	DisplayString	RO	N/A	N/A
.1.3.6.1.4.1.5454.1.90.1.1.2	sysOSVer	DisplayString	RO	N/A	N/A
.1.3.6.1.4.1.5454.1.90.1.1.3	sysFWVer	DisplayString	RO	N/A	N/A
.1.3.6.1.4.1.5454.1.90.1.1.4	sysPICVer	DisplayString	RO	N/A	N/A
.1.3.6.1.4.1.5454.1.90.1.1.5	sysModemVer	DisplayString	RO	N/A	N/A
.1.3.6.1.4.1.5454.1.90.1.1.6	sysODUFWVer	DisplayString	RO	N/A	N/A
.1.3.6.1.4.1.5454.1.90.1.2.1	sysFPGAPreVer	DisplayString	RO	N/A	N/A
.1.3.6.1.4.1.5454.1.90.1.2.2	sysOSPreVer	DisplayString	RO	N/A	N/A
.1.3.6.1.4.1.5454.1.90.1.2.3	sysFWPreVer	DisplayString	RO	N/A	N/A
.1.3.6.1.4.1.5454.1.90.1.2.4	sysPICPreVer	DisplayString	RO	N/A	N/A
.1.3.6.1.4.1.5454.1.90.1.2.5	sysModemPreVer	DisplayString	RO	N/A	N/A
.1.3.6.1.4.1.5454.1.90.1.2.6	sysODUFWPreVer	DisplayString	RO	N/A	N/A
.1.3.6.1.4.1.5454.1.90.1.3.1	sysIDUModel	DisplayString	RO	N/A	N/A
.1.3.6.1.4.1.5454.1.90.1.3.2	sysIDUSerialID	Integer	RO	N/A	N/A
.1.3.6.1.4.1.5454.1.90.1.3.3	sysODUModel	DisplayString	RO	N/A	N/A
.1.3.6.1.4.1.5454.1.90.1.3.4	sysODUSerialID	DisplayString	RO	N/A	N/A
.1.3.6.1.4.1.5454.1.90.1.4.1	sysMACeth1	DisplayString	RO	N/A	N/A
.1.3.6.1.4.1.5454.1.90.1.4.2	sysMACeth2	DisplayString	RO	N/A	N/A
.1.3.6.1.4.1.5454.1.90.1.5.1	sysIpAddress	IpAddr	RW	string size 16 (A.B.C.D)	192.168.100.100
.1.3.6.1.4.1.5454.1.90.1.5.2	sysSubnetMask	IpAddr	RW	string size 16 (A.B.C.D)	255.255.255.0
.1.3.6.1.4.1.5454.1.90.1.5.3	sysDefaultGateway	IpAddr	RW	string size 16 (A.B.C.D)	192.168.100.100
.1.3.6.1.4.1.5454.1.90.1.6.1	sysRemarkSystem	DisplayString	RW	string size 1..100	TrangoLink ApexPlus
.1.3.6.1.4.1.5454.1.90.1.7.1	sysIBMEnable	Integer	RW	0(Off), 1(On)	0(Off)
.1.3.6.1.4.1.5454.1.90.1.7.2	sysIBMIp	IpAddr	RW	string size 16 (A.B.C.D)	172.168.1.1
.1.3.6.1.4.1.5454.1.90.1.7.3	sysIBMNetmask	IpAddr	RW	string size 16 (A.B.C.D)	255.255.0.0
.1.3.6.1.4.1.5454.1.90.1.7.4	sysIBMManID	Integer	RW	0-4090	1
.1.3.6.1.4.1.5454.1.90.1.7.5	sysIBMManPort	Integer	RW	100	ge1

## Trango, cont'd

Object ID	Name	Type	Access	Range Limit	Default Value
.1.3.6.1.4.1.5454.1.90.1.8.1	sysSNMPReadCommStr	DisplayString	RW	string size 1-32	public
.1.3.6.1.4.1.5454.1.90.1.8.2	sysSNMPWriteCommStr	DisplayString	RW	string size 1-32	private
.1.3.6.1.4.1.5454.1.90.1.8.3	sysSNMPTrapCommStr	DisplayString	RW	string size 1-32	trapstr
.1.3.6.1.4.1.5454.1.90.1.9.1.1	sysSNMPTrap1Enable	Integer	RW	0(Off), 1(On)	0(OFF)
.1.3.6.1.4.1.5454.1.90.1.9.1.2	sysSNMPTrap1Ip	IpAddr	RW	string size 16 (A.B.C.D)	0.0.0.0
.1.3.6.1.4.1.5454.1.90.1.9.2.1	sysSNMPTrap2Enable	Integer	RW	0(Off), 1(On)	0(OFF)
.1.3.6.1.4.1.5454.1.90.1.9.2.2	sysSNMPTrap2Ip	IpAddr	RW	string size 16 (A.B.C.D)	0.0.0.0
.1.3.6.1.4.1.5454.1.90.1.9.3.1	sysSNMPTrap3Enable	Integer	RW	0(Off), 1(On)	0(OFF)
.1.3.6.1.4.1.5454.1.90.1.9.3.2	sysSNMPTrap3Ip	IpAddr	RW	string size 16 (A.B.C.D)	0.0.0.0
.1.3.6.1.4.1.5454.1.90.1.9.4.1	sysSNMPTrap4Enable	Integer	RW	0(Off), 1(On)	0(OFF)
.1.3.6.1.4.1.5454.1.90.1.9.4.2	sysSNMPTrap4Ip	IpAddr	RW	string size 16 (A.B.C.D)	0.0.0.0
.1.3.6.1.4.1.5454.1.90.1.9.5.1	sysSNMPTrap5Enable	Integer	RW	0(Off), 1(On)	0(OFF)
.1.3.6.1.4.1.5454.1.90.1.9.5.2	sysSNMPTrap5Ip	IpAddr	RW	string size 16 (A.B.C.D)	0.0.0.0
.1.3.6.1.4.1.5454.1.90.1.10.1	sysImageUpgrade	Integer	RW	1(IDU), 2(ODU)	0 (NA)
.1.3.6.1.4.1.5454.1.90.1.10.2	sysImageUpgradeStatus	Integer	RO	0(NA), 1(Failed)	0(NA)
.1.3.6.1.4.1.5454.1.90.1.10.3	sysImageToggle	Integer	RW	1(Toggle)	0(NA)
.1.3.6.1.4.1.5454.1.90.1.11	sysConfigOption	Integer	RW	1(Export), 2(Import), 3(Remove), 4(Save)	0(NA)
.1.3.6.1.4.1.5454.1.90.1.12.1	sysDiagnostic	Integer	RW	1(Export)	0(NA)
.1.3.6.1.4.1.5454.1.90.1.12.2	sysDiagnosticStatus	Integer	RO	0(NA), 1(Failed)	0(NA)
.1.3.6.1.4.1.5454.1.90.1.13.1	sysSyslogExport	Integer	RW	1(Export), 2(Clear)	0(NA)
.1.3.6.1.4.1.5454.1.90.1.13.2	sysSyslogLevel	Integer	RW		3
.1.3.6.1.4.1.5454.1.90.1.14	sysReboot	Integer	RW	1(REBOOT)	0 (NA)
.1.3.6.1.4.1.5454.1.90.1.15	sysResetOption	Integer	RW	0(Factory Default), 1(IP), 2(License)	0 (NA)
.1.3.6.1.4.1.5454.1.90.1.16	sysOMUTemp	Integer	RO		N/A
.1.3.6.1.4.1.5454.1.90.1.17.1	sysHTTPD	Integer	RW	0(Off), 1(On)	0(Off)
.1.3.6.1.4.1.5454.1.90.1.17.2	sysSNMPD	Integer	RW	0(Off), 1(On)	1(On)
.1.3.6.1.4.1.5454.1.90.1.17.3	sysTFTPD	Integer	RO	0(Off), 1(On)	1(On)
.1.3.6.1.4.1.5454.1.90.1.17.4	sysTelnetD	Integer	RW	0(Off), 1(On)	0(Off)
.1.3.6.1.4.1.5454.1.90.1.18	sysRPSEnable	Integer	RW	0(Off), 1(On)	0(Off)
.1.3.6.1.4.1.5454.1.90.1.19	sysClearCounter	Integer	RW	1(Clear)	0(NA)
.1.3.6.1.4.1.5454.1.90.1.20.1	sysSpeedLicenseEnable	Integer	RO	0(Disable), 1(Enable)	0(Disable)
.1.3.6.1.4.1.5454.1.90.1.20.1	sysSpeedLicenseKey1	String	RW	N/A	N/A
.1.3.6.1.4.1.5454.1.90.1.20.1	sysSpeedLicenseKey2	String	RW	N/A	N/A
.1.3.6.1.4.1.5454.1.90.1.21	sysFailoverMode	Integer	RW	0(Off), 1(ON with port OFF), 2(ON with port ON)	0
.1.3.6.1.4.1.5454.1.90.1.22	sysUtype	Integer	RO	0(NO Utype), 1 (Active), 2(Standby)	1(Active)
.1.3.6.1.4.1.5454.1.90.1.23	sysSync	Integer	RW	1(sync)	N/A
.1.3.6.1.4.1.5454.1.90.1.24.1	sysStandbyLinkStatus	Integer	RO	0(No Lock), 1(Lock)	N/A
.1.3.6.1.4.1.5454.1.90.1.24.2	sysStandbyODUStatus	Integer	RO	0(No Lock), 1(Lock)	N/A
.1.3.6.1.4.1.5454.1.90.1.24.3	sysStandbyRSSI	Integer	RO		N/A
.1.3.6.1.4.1.5454.1.90.1.24.4	sysStandbyMSE	Integer	RO		N/A
.1.3.6.1.4.1.5454.1.90.1.25	sysGuardTime	Integer	RW	10-60 seconds	15 second
.1.3.6.1.4.1.5454.1.90.1.26	sysSmartMode	Integer	RW	0(Off), 1(On)	1(On)

## Modem Section

Object ID	Name		Access	Range Limit	Default Value
.1.3.6.1.4.1.5454.1.90.2.1	modemLoopbackMode	Integer	RW	0(Off), 1(Digital), 2(IF), 3(Rf_gen), 4(Rf_refl)	0(Off)
.1.3.6.1.4.1.5454.1.90.2.2	modemDataPattern	Integer	RW	0(FPGA), 1(Modem)	0(FPGA)
.1.3.6.1.4.1.5454.1.90.2.3.1	modemACMEnable	Integer	RW	0(Off), 1(On)	0(Off)
.1.3.6.1.4.1.5454.1.90.2.3.2.1	modemACMProfileQPSKEnable	Integer	RO	0(Off), 1(On)	1(On)
.1.3.6.1.4.1.5454.1.90.2.3.2.2	modemACMProfile16QEnable	Integer	RO	0(Off), 1(On)	1(On)
.1.3.6.1.4.1.5454.1.90.2.3.2.3	modemACMProfile32QEnable	Integer	RO	0(Off), 1(On)	1(On)
.1.3.6.1.4.1.5454.1.90.2.3.2.4	modemACMProfile64QEnable	Integer	RO	0(Off), 1(On)	1(On)
.1.3.6.1.4.1.5454.1.90.2.3.2.5	modemACMProfile128QEnable	Integer	RO	0(Off), 1(On)	1(On)
.1.3.6.1.4.1.5454.1.90.2.3.2.6	modemACMProfile256QEnable	Integer	RO	0(Off), 1(On)	1(On)
.1.3.6.1.4.1.5454.1.90.2.3.3.1.1	modemACMQPSKMSEImprove	Opaque(Float)	RW	(-45) ~ 0	-20.3
.1.3.6.1.4.1.5454.1.90.2.3.3.1.2	modemACMQPSKMSEImproveInt	Integer	RW	(-4500) ~ 0	-2030
.1.3.6.1.4.1.5454.1.90.2.3.3.2.1	modemACM16QMSEImprove	Opaque(Float)	RW	(-45) ~ 0	-25.3
.1.3.6.1.4.1.5454.1.90.2.3.3.2.2	modemACM16QMSEImproveInt	Integer	RW	(-4500) ~ 0	-2530
.1.3.6.1.4.1.5454.1.90.2.3.3.3.1	modemACM32QMSEImprove	Opaque(Float)	RW	(-45) ~ 0	-26.3
.1.3.6.1.4.1.5454.1.90.2.3.3.3.2	modemACM32QMSEImproveInt	Integer	RW	(-4500) ~ 0	-2630
.1.3.6.1.4.1.5454.1.90.2.3.3.4.1	modemACM64QMSEImprove	Opaque(Float)	RW	(-45) ~ 0	-29.2
.1.3.6.1.4.1.5454.1.90.2.3.3.4.2	modemACM64QMSEImproveInt	Integer	RW	(-4500) ~ 0	-2920
.1.3.6.1.4.1.5454.1.90.2.3.3.5.1	modemACM128QMSEImprove	Opaque(Float)	RW	(-45) ~ 0	-32.1
.1.3.6.1.4.1.5454.1.90.2.3.3.5.2	modemACM128QMSEImproveInt	Integer	RW	(-4500) ~ 0	-3210
.1.3.6.1.4.1.5454.1.90.2.3.3.6.1	modemACM256QMSEImprove	Opaque(Float)	RW	(-45) ~ 0	-32.1
.1.3.6.1.4.1.5454.1.90.2.3.3.6.2	modemACM256QMSEImproveInt	Integer	RW	(-4500) ~ 0	-3210
.1.3.6.1.4.1.5454.1.90.2.3.4.1	modemACMQPSKMSEDegrad	Opaque(Float)	RW	(-45) ~ 0	-17.1
.1.3.6.1.4.1.5454.1.90.2.3.4.2	modemACM16QMSEDegrad	Opaque(Float)	RW	(-45) ~ 0	-18.5
.1.3.6.1.4.1.5454.1.90.2.3.4.3	modemACM32QMSEDegrad	Opaque(Float)	RW	(-45) ~ 0	-21.3
.1.3.6.1.4.1.5454.1.90.2.3.4.4	modemACM64QMSEDegrad	Opaque(Float)	RW	(-45) ~ 0	-24.3
.1.3.6.1.4.1.5454.1.90.2.3.4.5	modemACM128QMSEDegrad	Opaque(Float)	RW	(-45) ~ 0	-27.2
.1.3.6.1.4.1.5454.1.90.2.3.4.6	modemACM256QMSEDegrad	Opaque(Float)	RW	(-45) ~ 0	-27.2
.1.3.6.1.4.1.5454.1.90.2.3.5.1	modemACMTxProfile	Integer	RO	0(QPSK), 1(16Q), 2(32Q), 3(64Q), 4(128Q), 5(256Q) for non-256Q, 0(QPSK), 1(16Q), 2(64Q), 3(256Q) for 256Q	N/A
.1.3.6.1.4.1.5454.1.90.2.3.5.2	modemACMRxProfile	Integer	RO	0(QPSK), 1(16Q), 2(32Q), 3(64Q), 4(128Q), 5(256Q) for non-256Q, 0(QPSK), 1(16Q), 2(64Q), 3(256Q) for 256Q	N/A
.1.3.6.1.4.1.5454.1.90.2.4.1	modemBER	Integer	RO	N/A	N/A
.1.3.6.1.4.1.5454.1.90.2.4.2	modemMSE	Integer	RO	N/A	N/A
.1.3.6.1.4.1.5454.1.90.2.4.3	modemFER	Integer	RO	N/A	N/A
.1.3.6.1.4.1.5454.1.90.2.5.1	modemLockStatus	Integer	RO	0(No Lock), 1(Lock)	N/A
.1.3.6.1.4.1.5454.1.90.2.5.2	modemTimingLock	Integer	RO	0(No Lock), 1(Lock)	N/A
.1.3.6.1.4.1.5454.1.90.2.5.3	modemPreambleLock	Integer	RO	0(No Lock), 1(Lock)	N/A
.1.3.6.1.4.1.5454.1.90.2.5.4	modemLDPCLock	Integer	RO	0(No Lock), 1(Lock)	N/A

## RF Section

Object ID	Name		Access	Range Limit	Default Value
.1.3.6.1.4.1.5454.1.90.3.1.1.1	rfTxFrequency	Opaque(Float)	RW	ODU model dependant [In MHz]	0
.1.3.6.1.4.1.5454.1.90.3.1.1.2	rfTxFrequencyInt	Integer	RW	ODU model dependant [in KHz]	0
.1.3.6.1.4.1.5454.1.90.3.1.2.1	rfRxFrequency	Opaque(Float)	RO	ODU model dependant [In MHz]	0
.1.3.6.1.4.1.5454.1.90.3.1.2.2	rfRxFrequencyInt	Integer	RO	ODU model dependant [in KHz]	0
.1.3.6.1.4.1.5454.1.90.3.1.2.1	rfFreqDuplex	Opaque(Float)	RW	ODU model dependant [In MHz]	0
.1.3.6.1.4.1.5454.1.90.3.1.2.2	rfFreqDuplexInt	Integer	RW	ODU model dependant [in KHz]	0
.1.3.6.1.4.1.5454.1.90.3.2	rfDefaultOpmode	Integer	RW	0(Off), 1(On)	0(Off)
.1.3.6.1.4.1.5454.1.90.3.3	rfOpmode	Integer	RW	0(Off), 1(On)	0(Off)
.1.3.6.1.4.1.5454.1.90.3.4.1	rfPower	Opaque(Float)	RW	0-30	10
.1.3.6.1.4.1.5454.1.90.3.4.2	rfPowerInt	Integer	RW	0-300	100
.1.3.6.1.4.1.5454.1.90.3.5.1	rfChannelsWidth	Integer	RW	3-100	20
.1.3.6.1.4.1.5454.1.90.3.5.2	rfModulation	Integer	RW	0(QPSK), 1(16Q),2(32Q),3(64Q), 4(128Q), 5(256Q)	QAM128
.1.3.6.1.4.1.5454.1.90.3.5.3.1	rfSymrate	Opaque(Float)	RO	N/A	
.1.3.6.1.4.1.5454.1.90.3.5.3.2	rfSymrateInt	Integer	RO	N/A	24.6
.1.3.6.1.4.1.5454.1.90.3.5.4.1	rfSpeed	Opaque(Float)	RO	N/A	110
.1.3.6.1.4.1.5454.1.90.3.5.4.2	rfSpeedInt	Integer	RO	N/A	
.1.3.6.1.4.1.5454.1.90.3.6.1	rfATPCEnable	Integer	RW	0(Off), 1(On)	0(Off)
.1.3.6.1.4.1.5454.1.90.3.6.2	rfATPCMaxPower	Opaque(Float)	RW	17	17
.1.3.6.1.4.1.5454.1.90.3.6.3	rfATPCMaxPower_Int	Integer	RW	1700	1700
.1.3.6.1.4.1.5454.1.90.3.6.4	rfATPCStepSize	Integer	RW	0-5	1
.1.3.6.1.4.1.5454.1.90.3.7	rfAlignmentMode	Integer	RW	0(Off), 1(On)	0(Off)
.1.3.6.1.4.1.5454.1.90.3.8.1	rfTargetRSSI	Opaque(Float)	RW	(-88) ~ (-25)	-40
.1.3.6.1.4.1.5454.1.90.3.8.2	rfTargetRSSIInt	Integer	RW	(-880) ~ (-250) [10ths of dB ??]	-40
.1.3.6.1.4.1.5454.1.90.3.9	rfODUPowerEnable	Integer	RW	0(Off), 1(On)	0(Off)
.1.3.6.1.4.1.5454.1.90.3.10	rfODUTemp	Integer	RO	N/A	N/A
.1.3.6.1.4.1.5454.1.90.3.11.1	rfRSSI	Float	RO	N/A	N/A
.1.3.6.1.4.1.5454.1.90.3.11.2	rfRSSIInt	Integer	RO	N/A	
.1.3.6.1.4.1.5454.1.90.3.12.1	rfODURFpll	Integer	RO	0(No Lock), 1(Lock)	N/A
.1.3.6.1.4.1.5454.1.90.3.12.2	rfODUIFpll	Integer	RO	0(No Lock), 1(Lock)	N/A
.1.3.6.1.4.1.5454.1.90.3.12.3	rfODUTxpll	Integer	RO	0(No Lock), 1(Lock)	N/A
.1.3.6.1.4.1.5454.1.90.3.12.4	rfODURxpll	Integer	RO	0(No Lock), 1(Lock)	N/A
.1.3.6.1.4.1.5454.1.90.3.12.5	rfIDUTxpll	Integer	RO	0(No Lock), 1(Lock)	N/A
.1.3.6.1.4.1.5454.1.90.3.13.1	rfInDataOctets	Counter32	RO	N/A	N/A
.1.3.6.1.4.1.5454.1.90.3.13.2	rfInDataPackets	Counter32	RO	N/A	N/A
.1.3.6.1.4.1.5454.1.90.3.13.3	rfInDropPackets	Counter32	RO	N/A	N/A
.1.3.6.1.4.1.5454.1.90.3.13.4	rfInPortRate	Counter32	RO	N/A	
.1.3.6.1.4.1.5454.1.90.3.13.5	rfInPortUtil	Counter32	RO	N/A	N/A
.1.3.6.1.4.1.5454.1.90.3.14.1	rfOutDataOctets	Counter32	RO	N/A	N/A
.1.3.6.1.4.1.5454.1.90.3.14.2	rfOutDataPackets	Counter32	RO	N/A	N/A
.1.3.6.1.4.1.5454.1.90.3.14.3	rfOutPortRate	Counter32	RO	N/A	
.1.3.6.1.4.1.5454.1.90.3.14.4	rfOutPortUtil	Counter32	RO	N/A	N/A

## Ethernet Section

Object ID	Name		Access	Range Limit	Default Value
.1.3.6.1.4.1.5454.1.90.4.1.1.1	gigeEth1AutoNegotiate	Integer	RW	0(Off), 1(On)	1(On)
.1.3.6.1.4.1.5454.1.90.4.1.1.2	gigeEth1Duplex	Integer	RW	0(Half), 1(Full)	1(Full)
.1.3.6.1.4.1.5454.1.90.4.1.1.3	gigeEth1Enable	Integer	RW	0(Off), 1(On)	1(On)
.1.3.6.1.4.1.5454.1.90.4.1.1.4	gigeEth1MaxRate	Integer	RW	0-1000	1000
.1.3.6.1.4.1.5454.1.90.4.1.1.5	gigeEth1PauseFrame	Integer	RW	0(Off), 1(On)	0(Off)
.1.3.6.1.4.1.5454.1.90.4.1.1.6	gigeEth1Priority	Integer	RW	0-7	0
.1.3.6.1.4.1.5454.1.90.4.1.1.7	gigeEth1Speed	Integer	RW	0, 100, 1000	1000
.1.3.6.1.4.1.5454.1.90.4.1.1.8	gigeEth1Status	Integer	RO	0(Off), 1(On)	N/A
.1.3.6.1.4.1.5454.1.90.4.1.2.1	gigeEth1InOctets	Counter32	RO	0-4294967296	
.1.3.6.1.4.1.5454.1.90.4.1.2.2	gigeEth1InUcastPackets	Counter32	RO	0-4294967296	
.1.3.6.1.4.1.5454.1.90.4.1.2.3	gigeEth1InNUcastPackets	Counter32	RO	0-4294967296	
.1.3.6.1.4.1.5454.1.90.4.1.2.4	gigeEth1InTotalPackets	Counter32	RO	0-4294967296	
.1.3.6.1.4.1.5454.1.90.4.1.2.5	gigeEth1OutOctets	Counter32	RO	0-4294967296	
.1.3.6.1.4.1.5454.1.90.4.1.2.6	gigeEth1OutUcastPackets	Counter32	RO	0-4294967296	
.1.3.6.1.4.1.5454.1.90.4.1.2.7	gigeEth1OutNUcastPackets	Counter32	RO	0-4294967296	
.1.3.6.1.4.1.5454.1.90.4.1.2.8	gigeEth1OutTotalPackets	Counter32	RO	0-4294967296	
.1.3.6.1.4.1.5454.1.90.4.1.2.9	gigeEth1CRCErrors	Counter32	RO	0-4294967296	
.1.3.6.1.4.1.5454.1.90.4.1.2.10	gigeEth1CollisionErrors	Counter32	RO	0-4294967296	
.1.3.6.1.4.1.5454.1.90.4.2.1.1	gigeEth2AutoNegotiate	Integer	RW	0(Off), 1(On)	1(On)
.1.3.6.1.4.1.5454.1.90.4.2.1.2	gigeEth2Duplex	Integer	RW	0(Half), 1(Full)	1(Full)
.1.3.6.1.4.1.5454.1.90.4.2.1.3	gigeEth2Enable	Integer	RW	0(Off), 1(On)	1(On)
.1.3.6.1.4.1.5454.1.90.4.2.1.4	gigeEth2MaxRate	Integer	RW	0-1000	1000
.1.3.6.1.4.1.5454.1.90.4.2.1.5	gigeEth2PauseFrame	Integer	RW	0(Off), 1(On)	0(Off)
.1.3.6.1.4.1.5454.1.90.4.2.1.6	gigeEth2Priority	Integer	RW	0-7	0
.1.3.6.1.4.1.5454.1.90.4.2.1.7	gigeEth2Speed	Integer	RW	0, 100, 1000	1000
.1.3.6.1.4.1.5454.1.90.4.2.1.8	gigeEth2Status	Integer	RO	0(Off), 1(On)	N/A
.1.3.6.1.4.1.5454.1.90.4.2.2.1	gigeEth2InOctets	Counter32	RO	0-4294967296	
.1.3.6.1.4.1.5454.1.90.4.2.2.2	gigeEth2InUcastPackets	Counter32	RO	0-4294967296	
.1.3.6.1.4.1.5454.1.90.4.2.2.3	gigeEth2InNUcastPackets	Counter32	RO	0-4294967296	
.1.3.6.1.4.1.5454.1.90.4.2.2.4	gigeEth2InTotalPackets	Counter32	RO	0-4294967296	
.1.3.6.1.4.1.5454.1.90.4.2.2.5	gigeEth2OutOctets	Counter32	RO	0-4294967296	
.1.3.6.1.4.1.5454.1.90.4.2.2.6	gigeEth2OutUcastPackets	Counter32	RO	0-4294967296	
.1.3.6.1.4.1.5454.1.90.4.2.2.7	gigeEth2OutNUcastPackets	Counter32	RO	0-4294967296	
.1.3.6.1.4.1.5454.1.90.4.2.2.8	gigeEth2OutTotalPackets	Counter32	RO	0-4294967296	
.1.3.6.1.4.1.5454.1.90.4.2.2.9	gigeEth2CRCErrors	Counter32	RO	0-4294967296	
.1.3.6.1.4.1.5454.1.90.4.2.2.10	gigeEth2CollisionErrors	Counter32	RO	0-4294967296	
.1.3.6.1.4.1.5454.1.90.4.3.1	gigeEthPriority0COSQueue	Integer	RW	0-3	0
.1.3.6.1.4.1.5454.1.90.4.3.2	gigeEthPriority1COSQueue	Integer	RW	0-3	0
.1.3.6.1.4.1.5454.1.90.4.3.3	gigeEthPriority2COSQueue	Integer	RW	0-3	1
.1.3.6.1.4.1.5454.1.90.4.3.4	gigeEthPriority3COSQueue	Integer	RW	0-3	1
.1.3.6.1.4.1.5454.1.90.4.3.5	gigeEthPriority4COSQueue	Integer	RW	0-3	2
.1.3.6.1.4.1.5454.1.90.4.3.6	gigeEthPriority5COSQueue	Integer	RW	0-3	2
.1.3.6.1.4.1.5454.1.90.4.3.7	gigeEthPriority6COSQueue	Integer	RW	0-3	3
.1.3.6.1.4.1.5454.1.90.4.3.8	gigeEthPriority7COSQueue	Integer	RW	0-3	3

## Traps

Object ID	Name		Access	Range Limit	Default Value
.1.3.6.1.4.1.5454.1.90.5.1	trapStartUp		RO	N/A	N/A
.1.3.6.1.4.1.5454.1.90.5.2.1	trapReboot		RO	N/A	N/A
.1.3.6.1.4.1.5454.1.90.5.2.2	trapIPReset		RO	N/A	N/A
.1.3.6.1.4.1.5454.1.90.5.2.3	trapConfigReset		RO	N/A	N/A
.1.3.6.1.4.1.5454.1.90.5.3.1	trapRPSPortUp		RO	N/A	N/A
.1.3.6.1.4.1.5454.1.90.5.3.2	trapRPSPortDown		RO	N/A	N/A
.1.3.6.1.4.1.5454.1.90.5.4.1	trapEth1StatusUpdate		RO	0(OFF), 1(ON)	N/A
.1.3.6.1.4.1.5454.1.90.5.4.2	trapEth2StatusUpdate		RO	0(OFF), 1(ON)	N/A
.1.3.6.1.4.1.5454.1.90.5.5.1	trapLinkLock		RO	0(NORMAL), 1(LOCKED)	N/A
.1.3.6.1.4.1.5454.1.90.5.5.2	trapACMTxProfileChange		RO	0(QPSK), 1(16Q),2(32Q),3(64Q), 4(128Q), 5(256Q) for non-256Q, 0(QPSK), 1(16Q),2(64Q), 3(256Q) for 256Q	N/A
.1.3.6.1.4.1.5454.1.90.5.5.3	trapACMRxProfileChange		RO	0(QPSK), 1(16Q),2(32Q),3(64Q), 4(128Q), 5(256Q) for non-256Q, 0(QPSK), 1(16Q),2(64Q), 3(256Q) for 256Q	N/A
.1.3.6.1.4.1.5454.1.90.5.6.1	trapIDUTempMinThreshold		RO	Current IDU Temp	N/A
.1.3.6.1.4.1.5454.1.90.5.6.2	trapIDUTempMaxThreshold		RO	Current IDU Temp	N/A
.1.3.6.1.4.1.5454.1.90.5.6.3	trapODUTempMinThreshold		RO	Current ODU Temp	N/A
.1.3.6.1.4.1.5454.1.90.5.6.4	trapODUTempMaxThreshold		RO	Current ODU Temp	N/A
.1.3.6.1.4.1.5454.1.90.5.6.5	trapMSEMinThreshold		RO	Current MSE value	N/A
.1.3.6.1.4.1.5454.1.90.5.6.6	trapMSEMaxThreshold		RO	Current MSE value	N/A
.1.3.6.1.4.1.5454.1.90.5.6.7	trapBERMinThreshold		RO	Current BER value	N/A
.1.3.6.1.4.1.5454.1.90.5.6.8	trapBERMaxThreshold		RO	Current BER value	N/A
.1.3.6.1.4.1.5454.1.90.5.6.9	trapFERMinThreshold		RO	Current FER value	N/A
.1.3.6.1.4.1.5454.1.90.5.6.10	trapFERMaxThreshold		RO	Current FER value	N/A
.1.3.6.1.4.1.5454.1.90.5.6.11	trapRSSIMinThreshold		RO	Current RSSI value	N/A
.1.3.6.1.4.1.5454.1.90.5.6.12	trapRSSIMaxThreshold		RO	Current RSSI value	N/A
.1.3.6.1.4.1.5454.1.90.5.6.13	trapInPortUtilMinThreshold		RO	Current In port utilization	N/A
.1.3.6.1.4.1.5454.1.90.5.6.14	trapInPortUtilMaxThreshold		RO	Current In port utilization	N/A
.1.3.6.1.4.1.5454.1.90.5.6.15	trapOutPortUtilMinThreshold		RO	Current Out port utilization	N/A
.1.3.6.1.4.1.5454.1.90.5.6.16	trapOutPortUtilMaxThreshold		RO	Current Out port utilization	N/A
.1.3.6.1.4.1.5454.1.90.5.7.1	trapManualSwitchover		RO	1(Active), 2(Standby)	N/A
.1.3.6.1.4.1.5454.1.90.5.7.2	trapHWSwitchover		RO	1(Active), 2(Standby)	N/A
.1.3.6.1.4.1.5454.1.90.5.8.1	trapRedundancyCableRemoved		RO	N/A	N/A
.1.3.6.1.4.1.5454.1.90.5.8.2	trapRedundancyCableReconnected		RO	N/A	N/A
.1.3.6.1.4.1.5454.1.90.5.9.1	trapUtypeActiveElected		RO	N/A	N/A
.1.3.6.1.4.1.5454.1.90.5.9.2	trapUtypeStandbyElected		RO	N/A	N/A
.1.3.6.1.4.1.5454.1.90.5.9.3	trapActiveDetected		RO	N/A	N/A
.1.3.6.1.4.1.5454.1.90.5.9.4	trapStandbyDetected		RO	N/A	N/A
.1.3.6.1.4.1.5454.1.90.5.9.5	trapActiveDown		RO	N/A	N/A
.1.3.6.1.4.1.5454.1.90.5.9.6	trapStandbyDown		RO	N/A	N/A
.1.3.6.1.4.1.5454.1.90.5.10	trapSynchronization		RO	0(Not Synchronized), 1(Synchronized)	N/A

# Appendix E – Part Numbers

## ApexPlus Sub-bands/Tuning Ranges

ApexPlus Part Numbers	Description	TX Freq Min* (MHz)	TX Freq Max* (MHz)	Diplexer Range (MHz)	Max Chan Size (MHz)
<b>ApexPlus- 6 GHZ</b>					
AP2-06-0160-1A	ApexPlus HP2 6Ghz, ANSII/ETSI TR160, 1A - High Band	6,540	6,600	60	56
AP2-06-0160-1B	ApexPlus HP2 6Ghz, ANSII/ETSI TR160, 1B - High Band	6,700	6,760	60	56
AP2-06-0160-2A	ApexPlus HP2 6Ghz, ANSII/ETSI TR160, 2A - High Band	6,580	6,640	60	56
AP2-06-0160-2B	ApexPlus HP2 6Ghz, ANSII/ETSI TR160, 2B - High Band	6,740	6,800	60	56
AP2-06-0160-3A	ApexPlus HP2 6Ghz, ANSII/ETSI TR160, 3A - High Band	6,620	6,680	60	56
AP2-06-0160-3B	ApexPlus HP2 6Ghz, ANSII/ETSI TR160, 3B - High Band	6,780	6,840	60	56
AP2-06-0160-4A	ApexPlus HP2 6Ghz, ANSII/ETSI TR160, 4A - High Band	6,660	6,710	50	50
AP2-06-0160-4B	ApexPlus HP2 6Ghz, ANSII/ETSI TR160, 4B - High Band	6,820	6,870	50	50
AP2-06-0170-1A	ApexPlus HP2 6Ghz, ANSII/ETSI TR170, 1A - High Band	6,540	6,590	50	50
AP2-06-0170-1B	ApexPlus HP2 6Ghz, ANSII/ETSI TR170, 1B - High Band	6,710	6,760	50	50
AP2-06-0170-2A	ApexPlus HP2 6Ghz, ANSII/ETSI TR170, 2A - High Band	6,580	6,630	50	50
AP2-06-0170-2B	ApexPlus HP2 6Ghz, ANSII/ETSI TR170, 2B - High Band	6,750	6,800	50	50
AP2-06-0170-3A	ApexPlus HP2 6Ghz, ANSII/ETSI TR170, 3A - High Band	6,620	6,670	50	50
AP2-06-0170-3B	ApexPlus HP2 6Ghz, ANSII/ETSI TR170, 3B - High Band	6,790	6,840	50	50
AP2-06-0170-4A	ApexPlus HP2 6Ghz, ANSII/ETSI TR170, 4A - High Band	6,660	6,700	40	40
AP2-06-0170-4B	ApexPlus HP2 6Ghz, ANSII/ETSI TR170, 4B - High Band	6,830	6,870	40	40
AP1-06-0240-1A	Apex Plus HP 6Ghz,ETSI TR240, 1A - Low Band	5,925	6,025	100	56
AP1-06-0240-1B	ApexPlus HP 6Ghz, ETSI TR240, 1B - Low Band	6,175	6,275	100	56
AP1-06-0240-2A	ApexPlus HP 6Ghz, ETSI TR240, 2A - Low Band	6,000	6,100	100	56
AP1-06-0240-2B	ApexPlus HP 6Ghz, ETSI TR240, 2B - Low Band	6,250	6,350	100	56
AP1-06-0240-3A	ApexPlus HP 6Ghz, ETSI TR240, 3A - Low Band	6,075	6,175	100	56
AP1-06-0240-3B	ApexPlus HP 6Ghz, ETSI TR240, 3B - Low Band	6,325	6,425	100	56
AP2-06-0252-1A	ApexPlus HP2 6Ghz, ANSII/ETSI TR252, 1A - Low Band	5,915.55	5,989.68	74	56
AP2-06-0252-1B	ApexPlus HP2 6Ghz, ANSII/ETSI TR252, 1B - Low Band	6,167.59	6,241.72	74	56
AP2-06-0252-2A	ApexPlus HP2 6Ghz, ANSII/ETSI TR252, 2A - Low Band	5,974.85	6,048.98	74	56
AP2-06-0252-2B	ApexPlus HP2 6Ghz, ANSII/ETSI TR252, 2B - Low Band	6,226.89	6,301.02	74	56
AP2-06-0252-3A	ApexPlus HP2 6Ghz, ANSII/ETSI TR252, 3A - Low Band	6,034.15	6,108.28	74	56
AP2-06-0252-3B	ApexPlus HP2 6Ghz, ANSII/ETSI TR252, 3B - Low Band	6,286.19	6,360.32	74	56
AP2-06-0252-4A	ApexPlus HP2 6Ghz, ANSII/ETSI TR252, 4A - Low Band	6,093.45	6,167.58	74	56
AP2-06-0252-4B	ApexPlus HP2 6Ghz, ANSII/ETSI TR252, 4B - Low Band	6,345.49	6,419.62	74	56
AP1-06-0252-1A	ApexPlus HP 6Ghz, ANSII/ETSI TR252, 1A - Low Band	5,925	6,025	100	56
AP1-06-0252-1B	ApexPlus HP 6Ghz, ANSII/ETSI TR252, 1B - Low Band	6,175	6,275	100	56
AP1-06-0252-2A	ApexPlus HP 6Ghz, ANSII/ETSI TR252, 2A - Low Band	6,000	6,100	100	56
AP1-06-0252-2B	ApexPlus HP 6Ghz, ANSII/ETSI TR252, 2B - Low Band	6,250	6,350	100	56
AP1-06-0252-3A	ApexPlus HP 6Ghz, ANSII/ETSI TR252, 3A - Low Band	6,075	6,175	100	56
AP1-06-0252-3B	ApexPlus HP 6Ghz, ANSII/ETSI TR252, 3B - Low Band	6,325	6,425	100	56
AP2-06-0300-1A	ApexPlus HP2 6Ghz, ETSI TR300, 1A - Low Band	5,850	5,946	96	56
AP2-06-0300-1B	ApexPlus HP2 6Ghz, ETSI TR300, 1B - Low Band	6,150	6,246	96	56
AP2-06-0300-2A	ApexPlus HP2 6Ghz, ETSI TR300, 2A - Low Band	5,918	6,014	96	56
AP2-06-0300-2B	ApexPlus HP2 6Ghz, ETSI TR300, 2B - Low Band	6,218	6,314	96	56
AP2-06-0300-3A	ApexPlus HP2 6Ghz, ETSI TR300, 3A - Low Band	5,986	6,082	96	56
AP2-06-0300-3B	ApexPlus HP2 6Ghz, ETSI TR300, 3B - Low Band	6,286	6,382	96	56
AP2-06-0300-4A	ApexPlus HP2 6Ghz, ETSI TR300, 4A - Low Band	6,054	6,150	96	56
AP2-06-0300-4B	ApexPlus HP2 6Ghz, ETSI TR300, 4B - Low Band	6,354	6,450	96	56



Outdoor Unit Part Numbers	Description	TX Freq Min* (MHz)	TX Freq Max* (MHz)	Diplexer Range (MHz)	Max Chan Size (MHz)
AP2-06-0340-1A	ApexPlus HP2 6Ghz, ETSI TR340, 1A - High Band	6,425	6,509	84	56
AP2-06-0340-1B	ApexPlus HP2 6Ghz, ETSI TR340, 1B - High Band	6,765	6,849	84	56
AP2-06-0340-2A	ApexPlus HP2 6Ghz, ETSI TR340, 2A - High Band	6,481	6,564	83	56
AP2-06-0340-2B	ApexPlus HP2 6Ghz, ETSI TR340, 2B - High Band	6,821	6,904	83	56
AP2-06-0340-3A	ApexPlus HP2 6Ghz, ETSI TR340, 3A - High Band	6,536	6,619	83	56
AP2-06-0340-3B	ApexPlus HP2 6Ghz, ETSI TR340, 3B - High Band	6,876	6,959	83	56
AP2-06-0340-4A	ApexPlus HP2 6Ghz, ETSI TR340, 4A - High Band	6,591	6,674	83	56
AP2-06-0340-4B	ApexPlus HP2 6Ghz, ETSI TR340, 4B - High Band	6,931	7,014	83	56
AP2-06-0340-5A	ApexPlus HP2 6Ghz, ETSI TR340, 5A - High Band	6,646	6,729	83	56
AP2-06-0340-5B	ApexPlus HP2 6Ghz, ETSI TR340, 5B - High Band	6,986	7,069	83	56
AP2-06-0340-6A	ApexPlus HP2 6Ghz, ETSI TR340, 6A - High Band	6,701	6,785	84	56
AP2-06-0340-6B	ApexPlus HP2 6Ghz, ETSI TR340, 6B - High Band	7,041	7,125	84	56
AP1-06-0340-1A	ApexPlus HP 6Ghz, ETSI TR340, 1A - High Band	6,430	6,540	110	56
AP1-06-0340-1B	ApexPlus HP 6Ghz, ETSI TR340, 1B - High Band	6,770	6,880	110	56
AP1-06-0340-2A	ApexPlus HP 6Ghz, ETSI TR340, 2A - High Band	6,520	6,630	110	56
AP1-06-0340-2B	ApexPlus HP 6Ghz, ETSI TR340, 2B - High Band	6,860	6,970	110	56
AP1-06-0340-3A	ApexPlus HP 6Ghz, ETSI TR340, 3A - High Band	6,600	6,710	110	56
AP1-06-0340-3B	ApexPlus HP 6Ghz, ETSI TR340, 3B - High Band	6,940	7,050	110	56
AP1-06-0340-4A	ApexPlus HP 6Ghz, ETSI TR340, 4A - High Band	6,670	6,780	110	56
AP1-06-0340-4B	ApexPlus HP 6Ghz, ETSI TR340, 4B - High Band	7,010	7,120	110	56
AP2-06-0350-1A	ApexPlus HP2 6Ghz, ETSI TR350, 1A - High Band	6,425	6,499	74	56
AP2-06-0350-1B	ApexPlus HP2 6Ghz, ETSI TR350, 1B - High Band	6,775	6,849	74	56
AP2-06-0350-2A	ApexPlus HP2 6Ghz, ETSI TR350, 2A - High Band	6,481	6,554	73	56
AP2-06-0350-2B	ApexPlus HP2 6Ghz, ETSI TR350, 2B - High Band	6,831	6,904	73	56
AP2-06-0350-3A	ApexPlus HP2 6Ghz, ETSI TR350, 3A - High Band	6,536	6,609	73	56
AP2-06-0350-3B	ApexPlus HP2 6Ghz, ETSI TR350, 3B - High Band	6,886	6,959	73	56
AP2-06-0350-4A	ApexPlus HP2 6Ghz, ETSI TR350, 4A - High Band	6,591	6,664	73	56
AP2-06-0350-4B	ApexPlus HP2 6Ghz, ETSI TR350, 4B - High Band	6,941	7,014	73	56
AP2-06-0350-5A	ApexPlus HP2 6Ghz, ETSI TR350, 5A - High Band	6,646	6,719	73	56
AP2-06-0350-5B	ApexPlus HP2 6Ghz, ETSI TR350, 5B - High Band	6,996	7,069	73	56
AP2-06-0350-6A	ApexPlus HP2 6Ghz, ETSI TR350, 6A - High Band	6,701	6,775	74	56
AP2-06-0350-6B	ApexPlus HP2 6Ghz, ETSI TR350, 6B - High Band	7,051	7,125	74	56

Outdoor Unit Part Numbers	Description	TX Freq Min* (MHz)	TX Freq Max* (MHz)	Diplexer Range (MHz)	Max Chan Size (MHz)
------------------------------	-------------	-----------------------------	-----------------------------	----------------------------	------------------------------

### ApexPlus- 7 GHZ

AP2-07-0150-1A	ApexPlus HP2 7Ghz, ETSI TR150, 1A	6,875	6,945	70	70
AP2-07-0150-1B	ApexPlus HP2 7Ghz, ETSI TR150, 1B	7,025	7,095	70	70
AP2-07-0150-2A	ApexPlus HP2 7Ghz, ETSI TR150, 2A	6,905	6,975	70	70
AP2-07-0150-2B	ApexPlus HP2 7Ghz, ETSI TR150, 2B	7,055	7,125	70	70

AP2-07-0154-1A	ApexPlus HP2 7Ghz, ETSI TR154, 1A	7,428	7,484	56	56
AP2-07-0154-1B	ApexPlus HP2 7Ghz, ETSI TR154, 1B	7,582	7,638	56	56
AP2-07-0154-2A	ApexPlus HP2 7Ghz, ETSI TR154, 2A	7,470	7,526	56	56
AP2-07-0154-2B	ApexPlus HP2 7Ghz, ETSI TR154, 2B	7,624	7,680	56	56
AP2-07-0154-3A	ApexPlus HP2 7Ghz, ETSI TR154, 3A	7,512	7,568	56	56
AP2-07-0154-3B	ApexPlus HP2 7Ghz, ETSI TR154, 3B	7,666	7,722	56	56

AP1-07-0154-1A	ApexPlus HP 7Ghz, ETSI TR154, 1A	7,428	7,484	56	56
AP1-07-0154-1B	ApexPlus HP 7Ghz, ETSI TR154, 1B	7,582	7,638	56	56
AP1-07-0154-2A	ApexPlus HP 7Ghz, ETSI TR154, 2A	7,470	7,526	56	56
AP1-07-0154-2B	ApexPlus HP 7Ghz, ETSI TR154, 2B	7,624	7,680	56	56
AP1-07-0154-3A	ApexPlus HP 7Ghz, ETSI TR154, 3A	7,512	7,568	56	56
AP1-07-0154-3B	ApexPlus HP 7Ghz, ETSI TR154, 3B	7,666	7,722	56	56

AP2-07-0160-1A	ApexPlus HP2 7Ghz, ETSI TR160, 1A	7,434	7,497	63	56
AP2-07-0160-1B	ApexPlus HP2 7Ghz, ETSI TR160, 1B	7,594	7,657	63	56
AP2-07-0160-2A	ApexPlus HP2 7Ghz, ETSI TR160, 2A	7,479	7,542	63	56
AP2-07-0160-2B	ApexPlus HP2 7Ghz, ETSI TR160, 2B	7,639	7,702	63	56
AP2-07-0160-3A	ApexPlus HP2 7Ghz, ETSI TR160, 3A	7,526	7,589	63	56
AP2-07-0160-3B	ApexPlus HP2 7Ghz, ETSI TR160, 3B	7,686	7,749	63	56

AP1-07-0160-1A	ApexPlus HP 7Ghz, ETSI TR160, 1A	7,433.5	7,496.5	63	56
AP1-07-0160-1B	ApexPlus HP 7Ghz, ETSI TR160, 1B	7,593.5	7,656.5	63	56
AP1-07-0160-2A	ApexPlus HP 7Ghz, ETSI TR160, 2A	7,478.5	7,541.5	63	56
AP1-07-0160-2B	ApexPlus HP 7Ghz, ETSI TR160, 2B	7,638.5	7,701.5	63	56
AP1-07-0160-3A	ApexPlus HP 7Ghz, ETSI TR160, 3A	7,526.0	7,589.0	63	56
AP1-07-0160-3B	ApexPlus HP 7Ghz, ETSI TR160, 3B	7,686.0	7,749.0	63	56

AP2-07-0161-1A	ApexPlus HP2 7Ghz, ETSI TR161, 1A	7,114	7,177	63	56
AP2-07-0161-1B	ApexPlus HP2 7Ghz, ETSI TR161, 1B	7,275	7,338	63	56
AP2-07-0161-2A	ApexPlus HP2 7Ghz, ETSI TR161, 2A	7,149	7,212	63	56
AP2-07-0161-2B	ApexPlus HP2 7Ghz, ETSI TR161, 2B	7,310	7,373	63	56
AP2-07-0161-3A	ApexPlus HP2 7Ghz, ETSI TR161, 3A	7,184	7,247	63	56
AP2-07-0161-3B	ApexPlus HP2 7Ghz, ETSI TR161, 3B	7,345	7,408	63	56
AP2-07-0161-4A	ApexPlus HP2 7Ghz, ETSI TR161, 4A	7,219	7,282	63	56
AP2-07-0161-4B	ApexPlus HP2 7Ghz, ETSI TR161, 4B	7,380	7,443	63	56
AP2-07-0161-5A	ApexPlus HP2 7Ghz, ETSI TR161, 5A	7,239	7,302	63	56
AP2-07-0161-5B	ApexPlus HP2 7Ghz, ETSI TR161, 5B	7,400	7,463	63	56
AP2-07-0161-6A	ApexPlus HP2 7Ghz, ETSI TR161, 6A	7,274	7,337	63	56
AP2-07-0161-6B	ApexPlus HP2 7Ghz, ETSI TR161, 6B	7,435	7,498	63	56
AP2-07-0161-7A	ApexPlus HP2 7Ghz, ETSI TR161, 7A	7,309	7,372	63	56
AP2-07-0161-7B	ApexPlus HP2 7Ghz, ETSI TR161, 7B	7,470	7,533	63	56
AP2-07-0161-8A	ApexPlus HP2 7Ghz, ETSI TR161, 8A	7,344	7,407	63	56
AP2-07-0161-8B	ApexPlus HP2 7Ghz, ETSI TR161, 8B	7,505	7,568	63	56
AP2-07-0161-9A	ApexPlus HP2 7Ghz, ETSI TR161, 9A	7,414	7,477	63	56
AP2-07-0161-9B	ApexPlus HP2 7Ghz, ETSI TR161, 9B	7,575	7,638	63	56
AP2-07-0161-10A	ApexPlus HP2 7Ghz, ETSI TR161, 10A	7,449	7,512	63	56
AP2-07-0161-10B	ApexPlus HP2 7Ghz, ETSI TR161, 10B	7,610	7,673	63	56
AP2-07-0161-21A	ApexPlus HP2 7Ghz, ETSI TR161, 21A	7,484	7,547	63	56
AP2-07-0161-21B	ApexPlus HP2 7Ghz, ETSI TR161, 21B	7,645	7,708	63	56
AP2-07-0161-22A	ApexPlus HP2 7Ghz, ETSI TR161, 22A	7,519	7,582	63	56
AP2-07-0161-22B	ApexPlus HP2 7Ghz, ETSI TR161, 22B	7,680	7,743	63	56
AP2-07-0161-23A	ApexPlus HP2 7Ghz, ETSI TR161, 23A	7,539	7,602	63	56
AP2-07-0161-23B	ApexPlus HP2 7Ghz, ETSI TR161, 23B	7,700	7,763	63	56
AP2-07-0161-24A	ApexPlus HP2 7Ghz, ETSI TR161, 24A	7,574	7,637	63	56
AP2-07-0161-24B	ApexPlus HP2 7Ghz, ETSI TR161, 24B	7,735	7,798	63	56
AP2-07-0161-25A	ApexPlus HP2 7Ghz, ETSI TR161, 25A	7,609	7,672	63	56
AP2-07-0161-25B	ApexPlus HP2 7Ghz, ETSI TR161, 25B	7,770	7,833	63	56
AP2-07-0161-26A	ApexPlus HP2 7Ghz, ETSI TR161, 26A	7,644	7,707	63	56
AP2-07-0161-26B	ApexPlus HP2 7Ghz, ETSI TR161, 26B	7,805	7,868	63	56

Outdoor Unit Part Numbers	Description	TX Freq Min* (MHz)	TX Freq Max* (MHz)	Diplexer Range (MHz)	Max Chan Size (MHz)
AP1-07-0161-1A	ApexPlus HP 7Ghz, ETSI TR161, 1A	7,114	7,177	63	56
AP1-07-0161-1B	ApexPlus HP 7Ghz, ETSI TR161, 1B	7,275	7,338	63	56
AP1-07-0161-2A	ApexPlus HP 7Ghz, ETSI TR161, 2A	7,149	7,212	63	56
AP1-07-0161-2B	ApexPlus HP 7Ghz, ETSI TR161, 2B	7,310	7,373	63	56
AP1-07-0161-3A	ApexPlus HP 7Ghz, ETSI TR161, 3A	7,184	7,247	63	56
AP1-07-0161-3B	ApexPlus HP 7Ghz, ETSI TR161, 3B	7,345	7,408	63	56
AP1-07-0161-4A	ApexPlus HP 7Ghz, ETSI TR161, 4A	7,219	7,282	63	56
AP1-07-0161-4B	ApexPlus HP 7Ghz, ETSI TR161, 4B	7,380	7,443	63	56
AP1-07-0161-5A	ApexPlus HP 7Ghz, ETSI TR161, 5A	7,239	7,302	63	56
AP1-07-0161-5B	ApexPlus HP 7Ghz, ETSI TR161, 5B	7,400	7,463	63	56
AP1-07-0161-6A	ApexPlus HP 7Ghz, ETSI TR161, 6A	7,274	7,337	63	56
AP1-07-0161-6B	ApexPlus HP 7Ghz, ETSI TR161, 6B	7,435	7,498	63	56
AP1-07-0161-7A	ApexPlus HP 7Ghz, ETSI TR161, 7A	7,309	7,372	63	56
AP1-07-0161-7B	ApexPlus HP 7Ghz, ETSI TR161, 7B	7,470	7,533	63	56
AP1-07-0161-8A	ApexPlus HP 7Ghz, ETSI TR161, 8A	7,344	7,407	63	56
AP1-07-0161-8B	ApexPlus HP 7Ghz, ETSI TR161, 8B	7,505	7,568	63	56
AP1-07-0161-9A	ApexPlus HP 7Ghz, ETSI TR161, 9A	7,414	7,477	63	56
AP1-07-0161-9B	ApexPlus HP 7Ghz, ETSI TR161, 9B	7,575	7,638	63	56
AP1-07-0161-10A	ApexPlus HP 7Ghz, ETSI TR161, 10A	7,449	7,512	63	56
AP1-07-0161-10B	ApexPlus HP 7Ghz, ETSI TR161, 10B	7,610	7,673	63	56
AP1-07-0161-21A	ApexPlus HP 7Ghz, ETSI TR161, 21A	7,484	7,547	63	56
AP1-07-0161-21B	ApexPlus HP 7Ghz, ETSI TR161, 21B	7,645	7,708	63	56
AP1-07-0161-22A	ApexPlus HP 7Ghz, ETSI TR161, 22A	7,519	7,582	63	56
AP1-07-0161-22B	ApexPlus HP 7Ghz, ETSI TR161, 22B	7,680	7,743	63	56
AP1-07-0161-23A	ApexPlus HP 7Ghz, ETSI TR161, 23A	7,539	7,602	63	56
AP1-07-0161-23B	ApexPlus HP 7Ghz, ETSI TR161, 23B	7,700	7,763	63	56
AP1-07-0161-24A	ApexPlus HP 7Ghz, ETSI TR161, 24A	7,574	7,637	63	56
AP1-07-0161-24B	ApexPlus HP 7Ghz, ETSI TR161, 24B	7,735	7,798	63	56
AP1-07-0161-25A	ApexPlus HP 7Ghz, ETSI TR161, 25A	7,609	7,672	63	56
AP1-07-0161-25B	ApexPlus HP 7Ghz, ETSI TR161, 25B	7,770	7,833	63	56
AP1-07-0161-26A	ApexPlus HP 7Ghz, ETSI TR161, 26A	7,644	7,707	63	56
AP1-07-0161-26B	ApexPlus HP 7Ghz, ETSI TR161, 26B	7,805	7,868	63	56
AP2-07-0168-1A	ApexPlus HP2 7Ghz, ETSI TR168, 1A	7,443	7,499	56	56
AP2-07-0168-1B	ApexPlus HP2 7Ghz, ETSI TR168, 1B	7,611	7,667	56	56
AP2-07-0168-2A	ApexPlus HP2 7Ghz, ETSI TR168, 2A	7,485	7,541	56	56
AP2-07-0168-2B	ApexPlus HP2 7Ghz, ETSI TR168, 2B	7,653	7,709	56	56
AP2-07-0168-3A	ApexPlus HP2 7Ghz, ETSI TR168, 3A	7,527	7,583	56	56
AP2-07-0168-3B	ApexPlus HP2 7Ghz, ETSI TR168, 3B	7,695	7,751	56	56
AP1-07-0168-1A	ApexPlus HP 7Ghz, ETSI TR168, 1A	7,443	7,499	56	56
AP1-07-0168-1B	ApexPlus HP 7Ghz, ETSI TR168, 1B	7,611	7,667	56	56
AP1-07-0168-2A	ApexPlus HP 7Ghz, ETSI TR168, 2A	7,485	7,541	56	56
AP1-07-0168-2B	ApexPlus HP 7Ghz, ETSI TR168, 2B	7,653	7,709	56	56
AP1-07-0168-3A	ApexPlus HP 7Ghz, ETSI TR168, 3A	7,527	7,583	56	56
AP1-07-0168-3B	ApexPlus HP 7Ghz, ETSI TR168, 3B	7,695	7,751	56	56

Outdoor Unit Part Numbers	Description	TX Freq Min* (MHz)	TX Freq Max* (MHz)	Diplexer Range (MHz)	Max Chan Size (MHz)
AP2-07-0196-1A	ApexPlus HP2 7Ghz, ETSI TR196, 1A	7,093	7,149	56	56
AP2-07-0196-1B	ApexPlus HP2 7Ghz, ETSI TR196, 1B	7,289	7,345	56	56
AP2-07-0196-2A	ApexPlus HP2 7Ghz, ETSI TR196, 2A	7,121	7,177	56	56
AP2-07-0196-2B	ApexPlus HP2 7Ghz, ETSI TR196, 2B	7,317	7,373	56	56
AP2-07-0196-3A	ApexPlus HP2 7Ghz, ETSI TR196, 3A	7,149	7,205	56	56
AP2-07-0196-3B	ApexPlus HP2 7Ghz, ETSI TR196, 3B	7,345	7,401	56	56
AP2-07-0196-4A	ApexPlus HP2 7Ghz, ETSI TR196, 4A	7,177	7,233	56	56
AP2-07-0196-4B	ApexPlus HP2 7Ghz, ETSI TR196, 4B	7,373	7,429	56	56
AP2-07-0196-5A	ApexPlus HP2 7Ghz, ETSI TR196, 5A	7,205	7,261	56	56
AP2-07-0196-5B	ApexPlus HP2 7Ghz, ETSI TR196, 5B	7,401	7,457	56	56

AP1-07-0196-1A	ApexPlus HP 7Ghz, ETSI TR196, 1A	7,093	7,149	56	56
AP1-07-0196-1B	ApexPlus HP 7Ghz, ETSI TR196, 1B	7,289	7,345	56	56
AP1-07-0196-2A	ApexPlus HP 7Ghz, ETSI TR196, 2A	7,121	7,177	56	56
AP1-07-0196-2B	ApexPlus HP 7Ghz, ETSI TR196, 2B	7,317	7,373	56	56
AP1-07-0196-3A	ApexPlus HP 7Ghz, ETSI TR196, 3A	7,149	7,205	56	56
AP1-07-0196-3B	ApexPlus HP 7Ghz, ETSI TR196, 3B	7,345	7,401	56	56
AP1-07-0196-4A	ApexPlus HP 7Ghz, ETSI TR196, 4A	7,177	7,233	56	56
AP1-07-0196-4B	ApexPlus HP 7Ghz, ETSI TR196, 4B	7,373	7,429	56	56
AP1-07-0196-5A	ApexPlus HP 7Ghz, ETSI TR196, 5A	7,205	7,261	56	56
AP1-07-0196-5B	ApexPlus HP 7Ghz, ETSI TR196, 5B	7,401	7,457	56	56

AP2-07-0245-1A	ApexPlus HP2 7Ghz, ETSI TR245, 1A	7,400	7,484	84	56
AP2-07-0245-1B	ApexPlus HP2 7Ghz, ETSI TR245, 1B	7,645	7,729	84	56
AP2-07-0245-2A	ApexPlus HP2 7Ghz, ETSI TR245, 2A	7,484	7,568	84	56
AP2-07-0245-2B	ApexPlus HP2 7Ghz, ETSI TR245, 2B	7,729	7,813	84	56
AP2-07-0245-3A	ApexPlus HP2 7Ghz, ETSI TR245, 3A	7,568	7,652	84	56
AP2-07-0245-3B	ApexPlus HP2 7Ghz, ETSI TR245, 3B	7,813	7,897	84	56

AP1-07-0245-1A	ApexPlus HP 7Ghz, ETSI TR245, 1A	7,400	7,484	84	56
AP1-07-0245-1B	ApexPlus HP 7Ghz, ETSI TR245, 1B	7,645	7,729	84	56
AP1-07-0245-2A	ApexPlus HP 7Ghz, ETSI TR245, 2A	7,484	7,568	84	56
AP1-07-0245-2B	ApexPlus HP 7Ghz, ETSI TR245, 2B	7,729	7,813	84	56
AP1-07-0245-3A	ApexPlus HP 7Ghz, ETSI TR245, 3A	7,568	7,652	84	56
AP1-07-0245-3B	ApexPlus HP 7Ghz, ETSI TR245, 3B	7,813	7,897	84	56

Outdoor Unit Part Numbers	Description	TX Freq Min* (MHz)	TX Freq Max* (MHz)	Diplexer Range (MHz)	Max Chan Size (MHz)
---------------------------	-------------	--------------------	--------------------	----------------------	---------------------

## ApexPlus- 8 GHZ

AP2-08-0119-1A	ApexPlus HP2 8Ghz, ETSI TR119, 1A	8,279	8,307	28	28
AP2-08-0119-1B	ApexPlus HP2 8Ghz, ETSI TR119, 1B	8,398	8,426	28	28
AP2-08-0119-2A	ApexPlus HP2 8Ghz, ETSI TR119, 2A	8,293	8,321	28	28
AP2-08-0119-2B	ApexPlus HP2 8Ghz, ETSI TR119, 2B	8,412	8,440	28	28
AP2-08-0119-3A	ApexPlus HP2 8Ghz, ETSI TR119, 3A	8,307	8,335	28	28
AP2-08-0119-3B	ApexPlus HP2 8Ghz, ETSI TR119, 3B	8,426	8,454	28	28
AP2-08-0119-4A	ApexPlus HP2 8Ghz, ETSI TR119, 4A	8,321	8,349	28	28
AP2-08-0119-4B	ApexPlus HP2 8Ghz, ETSI TR119, 4B	8,440	8,468	28	28
AP2-08-0119-5A	ApexPlus HP2 8Ghz, ETSI TR119, 5A	8,335	8,363	28	28
AP2-08-0119-5B	ApexPlus HP2 8Ghz, ETSI TR119, 5B	8,454	8,482	28	28
AP2-08-0119-6A	ApexPlus HP2 8Ghz, ETSI TR119, 6A	8,349	8,377	28	28
AP2-08-0119-6B	ApexPlus HP2 8Ghz, ETSI TR119, 6B	8,468	8,496	28	28

AP1-08-0119-1A	ApexPlus HP 8Ghz, ETSI TR119, 1A	8,279	8,307	28	28
AP1-08-0119-1B	ApexPlus HP 8Ghz, ETSI TR119, 1B	8,398	8,426	28	28
AP1-08-0119-2A	ApexPlus HP 8Ghz, ETSI TR119, 2A	8,293	8,321	28	28
AP1-08-0119-2B	ApexPlus HP 8Ghz, ETSI TR119, 2B	8,412	8,440	28	28
AP1-08-0119-3A	ApexPlus HP 8Ghz, ETSI TR119, 3A	8,307	8,335	28	28
AP1-08-0119-3B	ApexPlus HP 8Ghz, ETSI TR119, 3B	8,426	8,454	28	28
AP1-08-0119-4A	ApexPlus HP 8Ghz, ETSI TR119, 4A	8,321	8,349	28	28
AP1-08-0119-4B	ApexPlus HP 8Ghz, ETSI TR119, 4B	8,440	8,468	28	28
AP1-08-0119-5A	ApexPlus HP 8Ghz, ETSI TR119, 5A	8,335	8,363	28	28
AP1-08-0119-5B	ApexPlus HP 8Ghz, ETSI TR119, 5B	8,454	8,482	28	28
AP1-08-0119-6A	ApexPlus HP 8Ghz, ETSI TR119, 6A	8,349	8,377	28	28
AP1-08-0119-6B	ApexPlus HP 8Ghz, ETSI TR119, 6B	8,468	8,496	28	28

AP1-08-0151-1A	ApexPlus HP 8Ghz, ETSI TR151, 1A	8,203	8,271	68	56
AP1-08-0151-1B	ApexPlus HP 8Ghz, ETSI TR151, 1B	8,355	8,423	68	56
AP1-08-0151-2A	ApexPlus HP 8Ghz, ETSI TR151, 2A	8,240	8,308	68	56
AP1-08-0151-2B	ApexPlus HP 8Ghz, ETSI TR151, 2B	8,392	8,460	68	56
AP1-08-0151-3A	ApexPlus HP 8Ghz, ETSI TR151, 3A	8,277	8,345	68	56
AP1-08-0151-3B	ApexPlus HP 8Ghz, ETSI TR151, 3B	8,429	8,497	68	56

AP2-08-0208-1A	ApexPlus HP2 8Ghz, ETSI TR208, 1A	8,043	8,113	70	56
AP2-08-0208-1B	ApexPlus HP2 8Ghz, ETSI TR208, 1B	8,251	8,321	70	56
AP2-08-0208-2A	ApexPlus HP2 8Ghz, ETSI TR208, 2A	8,099	8,169	70	56
AP2-08-0208-2B	ApexPlus HP2 8Ghz, ETSI TR208, 2B	8,307	8,377	70	56
AP2-08-0208-3A	ApexPlus HP2 8Ghz, ETSI TR208, 3A	8,155	8,225	70	56
AP2-08-0208-3B	ApexPlus HP2 8Ghz, ETSI TR208, 3B	8,363	8,433	70	56
AP2-08-0208-4A	ApexPlus HP2 8Ghz, ETSI TR208, 4A	8,211	8,281	70	56
AP2-08-0208-4B	ApexPlus HP2 8Ghz, ETSI TR208, 4B	8,419	8,489	70	56

AP1-08-0208-1A	ApexPlus HP 8Ghz, ETSI TR208, 1A	8,043	8,113	70	56
AP1-08-0208-1B	ApexPlus HP 8Ghz, ETSI TR208, 1B	8,251	8,321	70	56
AP1-08-0208-2A	ApexPlus HP 8Ghz, ETSI TR208, 2A	8,099	8,169	70	56
AP1-08-0208-2B	ApexPlus HP 8Ghz, ETSI TR208, 2B	8,307	8,377	70	56
AP1-08-0208-3A	ApexPlus HP 8Ghz, ETSI TR208, 3A	8,155	8,225	70	56
AP1-08-0208-3B	ApexPlus HP 8Ghz, ETSI TR208, 3B	8,363	8,433	70	56
AP1-08-0208-4A	ApexPlus HP 8Ghz, ETSI TR208, 4A	8,211	8,281	70	56
AP1-08-0208-4B	ApexPlus HP 8Ghz, ETSI TR208, 4B	8,419	8,489	70	56

Outdoor Unit Part Numbers	Description	TX Freq Min* (MHz)	TX Freq Max* (MHz)	Diplexer Range (MHz)	Max Chan Size (MHz)
AP2-08-0266-1A	ApexPlus HP2 8Ghz, ETSI TR266, 1A	7,905	8,024	119	56
AP2-08-0266-1B	ApexPlus HP2 8Ghz, ETSI TR266, 1B	8,171	8,290	119	56
AP2-08-0266-2A	ApexPlus HP2 8Ghz, ETSI TR266, 2A	8,017	8,136	119	56
AP2-08-0266-2B	ApexPlus HP2 8Ghz, ETSI TR266, 2B	8,283	8,402	119	56

AP1-08-0266-1A	ApexPlus HP 8Ghz, ETSI TR266, 1A	7,905	8,024	119	56
AP1-08-0266-1B	ApexPlus HP 8Ghz, ETSI TR266, 1B	8,171	8,290	119	56
AP1-08-0266-2A	ApexPlus HP 8Ghz, ETSI TR266, 2A	8,017	8,136	119	56
AP1-08-0266-2B	ApexPlus HP 8Ghz, ETSI TR266, 2B	8,283	8,402	119	56

AP2-08-0311-1A	ApexPlus HP2 8Ghz, ETSI TR311, 1A	7,731	7,867	136	56
AP2-08-0311-1B	ApexPlus HP2 8Ghz, ETSI TR311, 1B	8,042	8,178	136	56
AP2-08-0311-2A	ApexPlus HP2 8Ghz, ETSI TR311, 2A	7,835	7,971	136	56
AP2-08-0311-2B	ApexPlus HP2 8Ghz, ETSI TR311, 2B	8,146	8,282	136	56

AP1-08-0311-2A	ApexPlus HP 8Ghz, ETSI TR311, 2A	7,835	7,971	136	56
AP1-08-0311-2B	ApexPlus HP 8Ghz, ETSI TR311, 2B	8,146	8,282	136	56
AP1-08-0311-3A	ApexPlus HP 8Ghz, ETSI TR311, 3A	7,717	7,867	150	56
AP1-08-0311-3B	ApexPlus HP 8Ghz, ETSI TR311, 3B	8,028	8,178	150	56

### ApexPlus- 10 GHZ

AP2-10-0350-1A	ApexPlus HP2 10Ghz, ETSI TR350, 1A	10,150	10,300	150	56
AP2-10-0350-1B	ApexPlus HP2 10Ghz, ETSI TR350, 1B	10,500	10,650	150	56

### ApexPlus- 10.5 GHZ

AP2-10-091-1A	ApexPlus HP2 10Ghz, ETSI TR91, 1A	10,500	10,531	31	31
AP2-10-091-1B	ApexPlus HP2 10Ghz, ETSI TR91, 1B	10,591	10,622	31	31
AP2-10-091-2A	ApexPlus HP2 10Ghz, ETSI TR91, 2A	10,528	10,559	31	31
AP2-10-091-2B	ApexPlus HP2 10Ghz, ETSI TR91, 2B	10,619	10,650	31	31
AP2-10-091-3A	ApexPlus HP2 10Ghz, ETSI TR91, 3A	10,556	10,587	31	31
AP2-10-091-3B	ApexPlus HP2 10Ghz, ETSI TR91, 3B	10,647	10,678	31	31

### ApexPlus- 11 GHZ

AP2-11-0490-5A	ApexPlus HP2 11Ghz, ANS/ETSI TR490/500, 5A	10,700	10,890	190	56
AP2-11-0490-5B	ApexPlus HP2 11Ghz, ANS/ETSI TR490/500, 5B	11,200	11,390	190	56
AP2-11-0490-6A	ApexPlus HP2 11Ghz, ANS/ETSI TR490/500, 6A	10,855	11,045	190	56
AP2-11-0490-6B	ApexPlus HP2 11Ghz, ANS/ETSI TR490/500, 6B	11,355	11,545	190	56
AP2-11-0490-7A	ApexPlus HP2 11Ghz, ANS/ETSI TR490/500, 7A	11,010	11,200	190	56
AP2-11-0490-7B	ApexPlus HP2 11Ghz, ANS/ETSI TR490/500, 7B	11,510	11,700	190	56

AP1-11-0490-5A	ApexPlus HP 11Ghz, ANS/ETSI TR490/500, 5A	10,700	10,890	190	56
AP1-11-0490-5B	ApexPlus HP 11Ghz, ANS/ETSI TR490/500, 5B	11,200	11,390	190	56
AP1-11-0490-6A	ApexPlus HP 11Ghz, ANS/ETSI TR490/500, 6A	10,855	11,045	190	56
AP1-11-0490-6B	ApexPlus HP 11Ghz, ANS/ETSI TR490/500, 6B	11,355	11,545	190	56
AP1-11-0490-7A	ApexPlus HP 11Ghz, ANS/ETSI TR490/500, 7A	11,010	11,200	190	56
AP1-11-0490-7B	ApexPlus HP 11Ghz, ANS/ETSI TR490/500, 7B	11,510	11,700	190	56

AP2-11-0530-1A	ApexPlus HP2 11Ghz, ETSI TR530, 1A	10,675	10,855	180	56
AP2-11-0530-1B	ApexPlus HP2 11Ghz, ETSI TR530, 1B	11,205	11,385	180	56
AP2-11-0530-2A	ApexPlus HP2 11Ghz, ETSI TR530, 2A	10,795	10,975	180	56
AP2-11-0530-2B	ApexPlus HP2 11Ghz, ETSI TR530, 2B	11,325	11,505	180	56
AP2-11-0530-3A	ApexPlus HP2 11Ghz, ETSI TR530, 3A	10,915	11,135	220	56
AP2-11-0530-3B	ApexPlus HP2 11Ghz, ETSI TR530, 3B	11,445	11,665	220	56
AP2-11-0530-4A	ApexPlus HP2 11Ghz, ETSI TR530, 4A	11,035	11,215	180	56
AP2-11-0530-4B	ApexPlus HP2 11Ghz, ETSI TR530, 4B	11,565	11,745	180	56

AP1-11-0530-1A	ApexPlus HP 11Ghz, ETSI TR530, 1A	10,675	10,855	180	56
AP1-11-0530-1B	ApexPlus HP 11Ghz, ETSI TR530, 1B	11,205	11,385	180	56
AP1-11-0530-2A	ApexPlus HP 11Ghz, ETSI TR530, 2A	10,795	10,975	180	56
AP1-11-0530-2B	ApexPlus HP 11Ghz, ETSI TR530, 2B	11,325	11,505	180	56
AP1-11-0530-3A	ApexPlus HP 11Ghz, ETSI TR530, 3A	10,915	11,135	220	56
AP1-11-0530-3B	ApexPlus HP 11Ghz, ETSI TR530, 3B	11,445	11,665	220	56
AP1-11-0530-4A	ApexPlus HP 11Ghz, ETSI TR530, 4A	11,035	11,215	180	56
AP1-11-0530-4B	ApexPlus HP 11Ghz, ETSI TR530, 4B	11,565	11,745	180	56

Outdoor Unit Part Numbers	Description	TX Freq Min* (MHz)	TX Freq Max* (MHz)	Diplexer Range (MHz)	Max Chan Size (MHz)
------------------------------	-------------	-----------------------------	-----------------------------	----------------------------	------------------------------

### ApexPlus- 13 GHZ

AP2-13-0225-1A	ApexPlus HP2 13Ghz, ANSI TR225, 1A	12,700	12,815	115	115
AP2-13-0225-1B	ApexPlus HP2 13Ghz, ANSI TR225, 1B	12,925	13,040	115	115
AP2-13-0225-2A	ApexPlus HP2 13Ghz, ANSI TR225, 2A	12,755	12,870	115	115
AP2-13-0225-2B	ApexPlus HP2 13Ghz, ANSI TR225, 2B	12,980	13,095	115	115
AP2-13-0225-3A	ApexPlus HP2 13Ghz, ANSI TR225, 3A	12,810	12,925	115	115
AP2-13-0225-3B	ApexPlus HP2 13Ghz, ANSI TR225, 3B	13,035	13,150	115	115

AP2-13-0266-1A	ApexPlus HP2 13Ghz, ETSI TR266, 1A	12,751	12,814	63	56
AP2-13-0266-1B	ApexPlus HP2 13Ghz, ETSI TR266, 1B	13,017	13,080	63	56
AP2-13-0266-2A	ApexPlus HP2 13Ghz, ETSI TR266, 2A	12,807	12,870	63	56
AP2-13-0266-2B	ApexPlus HP2 13Ghz, ETSI TR266, 2B	13,073	13,136	63	56
AP2-13-0266-3A	ApexPlus HP2 13Ghz, ETSI TR266, 3A	12,863	12,926	63	56
AP2-13-0266-3B	ApexPlus HP2 13Ghz, ETSI TR266, 3B	13,129	13,192	63	56
AP2-13-0266-4A	ApexPlus HP2 13Ghz, ETSI TR266, 4A	12,919	12,982	63	56
AP2-13-0266-4B	ApexPlus HP2 13Ghz, ETSI TR266, 4B	13,185	13,248	63	56

AP1-13-0266-1A	ApexPlus HP 13Ghz, ETSI TR266, 1A	12,751	12,814	63	56
AP1-13-0266-1B	ApexPlus HP 13Ghz, ETSI TR266, 1B	13,017	13,080	63	56
AP1-13-0266-2A	ApexPlus HP 13Ghz, ETSI TR266, 2A	12,807	12,870	63	56
AP1-13-0266-2B	ApexPlus HP 13Ghz, ETSI TR266, 2B	13,073	13,136	63	56
AP1-13-0266-3A	ApexPlus HP 13Ghz, ETSI TR266, 3A	12,863	12,926	63	56
AP1-13-0266-3B	ApexPlus HP 13Ghz, ETSI TR266, 3B	13,129	13,192	63	56
AP1-13-0266-4A	ApexPlus HP 13Ghz, ETSI TR266, 4A	12,919	12,982	63	56
AP1-13-0266-4B	ApexPlus HP 13Ghz, ETSI TR266, 4B	13,185	13,248	63	56

### ApexPlus- 15 GHZ

AP2-15-0315-1A	ApexPlus HP2 15Ghz, ETSI TR315, 1A	14,627	14,732	105	56
AP2-15-0315-1B	ApexPlus HP2 15Ghz, ETSI TR315, 1B	14,942	15,047	105	56
AP2-15-0315-2A	ApexPlus HP2 15Ghz, ETSI TR315, 2A	14,725	14,844	119	56
AP2-15-0315-2B	ApexPlus HP2 15Ghz, ETSI TR315, 2B	15,040	15,159	119	56
AP2-15-0315-3A	ApexPlus HP2 15Ghz, ETSI TR315, 3A	14,823	14,928	105	56
AP2-15-0315-3B	ApexPlus HP2 15Ghz, ETSI TR315, 3B	15,138	15,243	105	56

AP1-15-0315-1A	ApexPlus HP 15Ghz, ETSI TR315, 1A	14,627	14,746	119	56
AP1-15-0315-1B	ApexPlus HP 15Ghz, ETSI TR315, 1B	14,942	15,061	119	56
AP1-15-0315-2A	ApexPlus HP 15Ghz, ETSI TR315, 2A	14,725	14,844	119	56
AP1-15-0315-2B	ApexPlus HP 15Ghz, ETSI TR315, 2B	15,040	15,159	119	56
AP1-15-0315-3A	ApexPlus HP 15Ghz, ETSI TR315, 3A	14,823	14,942	119	56
AP1-15-0315-3B	ApexPlus HP 15Ghz, ETSI TR315, 3B	15,138	15,257	119	56

AP2-15-0420-4A	ApexPlus HP2 15Ghz, ETSI TR420, 4A	14,501	14,613	112	56
AP2-15-0420-4B	ApexPlus HP2 15Ghz, ETSI TR420, 4B	14,921	15,033	112	56
AP2-15-0420-5A	ApexPlus HP2 15Ghz, ETSI TR420, 5A	14,606	14,725	119	56
AP2-15-0420-5B	ApexPlus HP2 15Ghz, ETSI TR420, 5B	15,026	15,145	119	56
AP2-15-0420-6A	ApexPlus HP2 15Ghz, ETSI TR420, 6A	14,718	14,837	119	56
AP2-15-0420-6B	ApexPlus HP2 15Ghz, ETSI TR420, 6B	15,138	15,257	119	56
AP2-15-0420-7A	ApexPlus HP2 15Ghz, ETSI TR420, 7A	14,816	14,928	112	56
AP2-15-0420-7B	ApexPlus HP2 15Ghz, ETSI TR420, 7B	15,236	15,348	112	56

AP1-15-0420-4A	ApexPlus HP 15Ghz, ETSI TR420, 4A	14,501	14,613	112	56
AP1-15-0420-4B	ApexPlus HP 15Ghz, ETSI TR420, 4B	14,921	15,033	112	56
AP1-15-0420-5A	ApexPlus HP 15Ghz, ETSI TR420, 5A	14,606	14,725	119	56
AP1-15-0420-5B	ApexPlus HP 15Ghz, ETSI TR420, 5B	15,026	15,145	119	56
AP1-15-0420-6A	ApexPlus HP 15Ghz, ETSI TR420, 6A	14,718	14,837	119	56
AP1-15-0420-6B	ApexPlus HP 15Ghz, ETSI TR420, 6B	15,138	15,257	119	56
AP1-15-0420-7A	ApexPlus HP 15Ghz, ETSI TR420, 7A	14,816	14,928	112	56
AP1-15-0420-7B	ApexPlus HP 15Ghz, ETSI TR420, 7B	15,236	15,348	112	56

Outdoor Unit Part Numbers	Description	TX Freq Min* (MHz)	TX Freq Max* (MHz)	Diplexer Range (MHz)	Max Chan Size (MHz)
AP2-15-0490-4A	ApexPlus HP2 15Ghz, ETSI TR490, 4A	14,403	14,522	119	56
AP2-15-0490-4B	ApexPlus HP2 15Ghz, ETSI TR490, 4B	14,893	15,012	119	56
AP2-15-0490-5A	ApexPlus HP2 15Ghz, ETSI TR490, 5A	14,515	14,634	119	56
AP2-15-0490-5B	ApexPlus HP2 15Ghz, ETSI TR490, 5B	15,005	15,124	119	56
AP2-15-0490-6A	ApexPlus HP2 15Ghz, ETSI TR490, 6A	14,627	14,746	119	56
AP2-15-0490-6B	ApexPlus HP2 15Ghz, ETSI TR490, 6B	15,117	15,236	119	56
AP2-15-0490-7A	ApexPlus HP2 15Ghz, ETSI TR490, 7A	14,739	14,858	119	56
AP2-15-0490-7B	ApexPlus HP2 15Ghz, ETSI TR490, 7B	15,229	15,348	119	56
AP1-15-0490-4A	ApexPlus HP 15Ghz, ETSI TR490, 4A	14,403	14,522	119	56
AP1-15-0490-4B	ApexPlus HP 15Ghz, ETSI TR490, 4B	14,893	15,012	119	56
AP1-15-0490-5A	ApexPlus HP 15Ghz, ETSI TR490, 5A	14,515	14,634	119	56
AP1-15-0490-5B	ApexPlus HP 15Ghz, ETSI TR490, 5B	15,005	15,124	119	56
AP1-15-0490-6A	ApexPlus HP 15Ghz, ETSI TR490, 6A	14,627	14,746	119	56
AP1-15-0490-6B	ApexPlus HP 15Ghz, ETSI TR490, 6B	15,117	15,236	119	56
AP1-15-0490-7A	ApexPlus HP 15Ghz, ETSI TR490, 7A	14,739	14,858	119	56
AP1-15-0490-7B	ApexPlus HP 15Ghz, ETSI TR490, 7B	15,229	15,348	119	56
AP2-15-0475-1A	ApexPlus HP2 15Ghz, ETSI TR475, 1A	14,500	14,668	168	56
AP2-15-0475-1B	ApexPlus HP2 15Ghz, ETSI TR475, 1B	14,975	15,143	168	56
AP2-15-0475-2A	ApexPlus HP2 15Ghz, ETSI TR475, 2A	14,660	14,828	168	56
AP2-15-0475-2B	ApexPlus HP2 15Ghz, ETSI TR475, 2B	15,135	15,303	168	56
AP2-15-0475-3A	ApexPlus HP2 15Ghz, ETSI TR475, 3A	14,715	14,883	168	56
AP2-15-0475-3B	ApexPlus HP2 15Ghz, ETSI TR475, 3B	15,190	15,358	168	56
AP1-15-0475-1A	ApexPlus HP 15Ghz, ETSI TR475, 1A	14,500	14,668	168	56
AP1-15-0475-1B	ApexPlus HP 15Ghz, ETSI TR475, 1B	14,975	15,143	168	56
AP1-15-0475-2A	ApexPlus HP 15Ghz, ETSI TR475, 2A	14,660	14,828	168	56
AP1-15-0475-2B	ApexPlus HP 15Ghz, ETSI TR475, 2B	15,135	15,303	168	56
AP1-15-0475-3A	ApexPlus HP 15Ghz, ETSI TR475, 3A	14,783	14,883	100	56
AP1-15-0475-3B	ApexPlus HP 15Ghz, ETSI TR475, 3B	15,258	15,358	100	56
AP2-15-0640-1A	ApexPlus HP2 15Ghz, ETSI TR640, 1A	14,500	14,610	110	56
AP2-15-0640-1B	ApexPlus HP2 15Ghz, ETSI TR640, 1B	15,140	15,250	110	56
AP2-15-0640-2A	ApexPlus HP2 15Ghz, ETSI TR640, 2A	14,605	14,715	110	56
AP2-15-0640-2B	ApexPlus HP2 15Ghz, ETSI TR640, 2B	15,245	15,355	110	56
AP1-15-0640-1A	ApexPlus HP 15Ghz, ETSI TR640, 1A	14,500	14,610	110	56
AP1-15-0640-1B	ApexPlus HP 15Ghz, ETSI TR640, 1B	15,140	15,250	110	56
AP1-15-0640-2A	ApexPlus HP 15Ghz, ETSI TR640, 2A	14,605	14,715	110	56
AP1-15-0640-2B	ApexPlus HP 15Ghz, ETSI TR640, 2B	15,245	15,355	110	56
AP2-15-0644-1A	ApexPlus HP2 15Ghz, ETSI TR644, 1A	14,400	14,512	112	56
AP2-15-0644-1B	ApexPlus HP2 15Ghz, ETSI TR644, 1B	15,044	15,156	112	56
AP2-15-0644-2A	ApexPlus HP2 15Ghz, ETSI TR644, 2A	14,498	14,610	112	56
AP2-15-0644-2B	ApexPlus HP2 15Ghz, ETSI TR644, 2B	15,142	15,254	112	56
AP2-15-0644-3A	ApexPlus HP2 15Ghz, ETSI TR644, 3A	14,596	14,708	112	56
AP2-15-0644-3B	ApexPlus HP2 15Ghz, ETSI TR644, 3B	15,240	15,352	112	56
AP1-15-0644-1A	ApexPlus HP 15Ghz, ETSI TR644, 1A	14,400	14,512	112	56
AP1-15-0644-1B	ApexPlus HP 15Ghz, ETSI TR644, 1B	15,044	15,156	112	56
AP1-15-0644-2A	ApexPlus HP 15Ghz, ETSI TR644, 2A	14,498	14,610	112	56
AP1-15-0644-2B	ApexPlus HP 15Ghz, ETSI TR644, 2B	15,142	15,254	112	56
AP1-15-0644-3A	ApexPlus HP 15Ghz, ETSI TR644, 3A	14,596	14,708	112	56
AP1-15-0644-3B	ApexPlus HP 15Ghz, ETSI TR644, 3B	15,240	15,352	112	56



Outdoor Unit Part Numbers	Description	TX Freq Min* (MHz)	TX Freq Max* (MHz)	Diplexer Range (MHz)	Max Chan Size (MHz)
AP1-15-0728-1A	ApexPlus HP 15Ghz, ETSI TR728, 1A	14,500	14,615	115	56
AP1-15-0728-1B	ApexPlus HP 15Ghz, ETSI TR728, 1B	15,228	15,343	115	56
AP1-15-0728-2A	ApexPlus HP 15Ghz, ETSI TR728, 2A	14,500	14,625	125	56
AP1-15-0728-2B	ApexPlus HP 15Ghz, ETSI TR728, 2B	15,228	15,353	125	56

AP2-15-0728-1A	ApexPlus HP2 15Ghz, ETSI TR728, 1A	14,500	14,615	115	56
AP2-15-0728-1B	ApexPlus HP2 15Ghz, ETSI TR728, 1B	15,228	15,343	115	56

## ApexPlus- 18 GHZ

AP2-18-1010-1A	ApexPlus HP2 18Ghz, ETSI TR1010/1008, 1A	17,685	17,985	300	56
AP2-18-1010-1B	ApexPlus HP2 18Ghz, ETSI TR1010/1008, 1B	18,695	18,995	300	56
AP2-18-1010-2A	ApexPlus HP2 18Ghz, ETSI TR1010/1008, 2A	17,930	18,230	300	56
AP2-18-1010-2B	ApexPlus HP2 18Ghz, ETSI TR1010/1008, 2B	18,940	19,240	300	56
AP2-18-1010-3A	ApexPlus HP2 18Ghz, ETSI TR1010/1008, 3A	18,180	18,480	300	56
AP2-18-1010-3B	ApexPlus HP2 18Ghz, ETSI TR1010/1008, 3B	19,190	19,490	300	56
AP2-18-1010-4A	ApexPlus HP2 18Ghz, ETSI TR1010/1008, 4A	18,400	18,700	300	56
AP2-18-1010-4B	ApexPlus HP2 18Ghz, ETSI TR1010/1008, 4B	19,410	19,710	300	56

AP1-18-1010-1A	ApexPlus HP 18Ghz, ETSI TR1010/1008, 1A	17,685	17,985	300	56
AP1-18-1010-1B	ApexPlus HP 18Ghz, ETSI TR1010/1008, 1B	18,695	18,995	300	56
AP1-18-1010-2A	ApexPlus HP 18Ghz, ETSI TR1010/1008, 2A	17,930	18,230	300	56
AP1-18-1010-2B	ApexPlus HP 18Ghz, ETSI TR1010/1008, 2B	18,940	19,240	300	56
AP1-18-1010-3A	ApexPlus HP 18Ghz, ETSI TR1010/1008, 3A	18,180	18,480	300	56
AP1-18-1010-3B	ApexPlus HP 18Ghz, ETSI TR1010/1008, 3B	19,190	19,490	300	56
AP1-18-1010-4A	ApexPlus HP 18Ghz, ETSI TR1010/1008, 4A	18,400	18,700	300	56
AP1-18-1010-4B	ApexPlus HP 18Ghz, ETSI TR1010/1008, 4B	19,410	19,710	300	56

AP1-18-1092-1A	ApexPlus HP 18Ghz, ETSI TR1092, 1A	17,700	18,060	360	56
AP1-18-1092-1B	ApexPlus HP 18Ghz, ETSI TR1092, 1B	18,805	19,165	360	56
AP1-18-1092-2A	ApexPlus HP 18Ghz, ETSI TR1092, 2A	17,975	18,335	360	56
AP1-18-1092-2B	ApexPlus HP 18Ghz, ETSI TR1092, 2B	19,080	19,440	360	56
AP1-18-1092-3A	ApexPlus HP 18Ghz, ETSI TR1092, 3A	18,235	18,595	360	56
AP1-18-1092-3B	ApexPlus HP 18Ghz, ETSI TR1092, 3B	19,340	19,700	360	56

AP2-18-1560-3A	ApexPlus HP2 18Ghz, ANSI TR1560, 3A	17,700	18,140	440	56
AP2-18-1560-3B	ApexPlus HP2 18Ghz, ANSI TR1560, 3B	19,260	19,700	440	56

AP1-18-1560-3A	ApexPlus HP 18Ghz, ANSI TR1560, 3A	17,700	18,140	440	56
AP1-18-1560-3B	ApexPlus HP 18Ghz, ANSI TR1560, 3B	19,260	19,700	440	56

Outdoor Unit Part Numbers	Description	TX Freq Min* (MHz)	TX Freq Max* (MHz)	Diplexer Range (MHz)	Max Chan Size (MHz)
------------------------------	-------------	-----------------------------	-----------------------------	----------------------------	------------------------------

## ApexPlus- 23 GHZ

AP2-23-1008-1A	ApexPlus HP2 23Ghz, ETSI TR1008, 1A	22,000	22,314	314	56
AP2-23-1008-1B	ApexPlus HP2 23Ghz, ETSI TR1008, 1B	23,008	23,322	314	56
AP2-23-1008-2A	ApexPlus HP2 23Ghz, ETSI TR1008, 2A	22,286	22,600	314	56
AP2-23-1008-2B	ApexPlus HP2 23Ghz, ETSI TR1008, 2B	23,294	23,608	314	56

AP1-23-1008-1A	ApexPlus HP 23Ghz, ETSI TR1008, 1A	21,994	22,330	336	56
AP1-23-1008-1B	ApexPlus HP 23Ghz, ETSI TR1008, 1B	23,002	23,338	336	56
AP1-23-1008-2A	ApexPlus HP 23Ghz, ETSI TR1008, 2A	22,274	22,610	336	56
AP1-23-1008-2B	ApexPlus HP 23Ghz, ETSI TR1008, 2B	23,282	23,618	336	56

AP2-23-1200-5A	ApexPlus HP2 23Ghz, ANSI TR1200, 5A	21,200	21,600	400	56
AP2-23-1200-5B	ApexPlus HP2 23Ghz, ANSI TR1200, 5B	22,400	22,800	400	56
AP2-23-1200-6A	ApexPlus HP2 23Ghz, ANSI TR1200, 6A	21,600	22,000	400	56
AP2-23-1200-6B	ApexPlus HP2 23Ghz, ANSI TR1200, 6B	22,800	23,200	400	56
AP2-23-1200-7A	ApexPlus HP2 23Ghz, ANSI TR1200, 7A	22,000	22,400	400	56
AP2-23-1200-7B	ApexPlus HP2 23Ghz, ANSI TR1200, 7B	23,200	23,600	400	56

AP1-23-1200-5A	ApexPlus HP 23Ghz, ANSI TR1200, 5A	21,200	21,600	400	56
AP1-23-1200-5B	ApexPlus HP 23Ghz, ANSI TR1200, 5B	22,400	22,800	400	56
AP1-23-1200-6A	ApexPlus HP 23Ghz, ANSI TR1200, 6A	21,600	22,000	400	56
AP1-23-1200-6B	ApexPlus HP 23Ghz, ANSI TR1200, 6B	22,800	23,200	400	56
AP1-23-1200-7A	ApexPlus HP 23Ghz, ANSI TR1200, 7A	22,000	22,400	400	56
AP1-23-1200-7B	ApexPlus HP 23Ghz, ANSI TR1200, 7B	23,200	23,600	400	56

AP2-23-1232-1A	ApexPlus HP2 23Ghz, ETSI TR1232, 1A	21,200	21,500	300	56
AP2-23-1232-1B	ApexPlus HP2 23Ghz, ETSI TR1232, 1B	22,432	22,732	300	56
AP2-23-1232-2A	ApexPlus HP2 23Ghz, ETSI TR1232, 2A	21,472	21,786	314	56
AP2-23-1232-2B	ApexPlus HP2 23Ghz, ETSI TR1232, 2B	22,704	23,018	314	56
AP2-23-1232-3A	ApexPlus HP2 23Ghz, ETSI TR1232, 3A	21,779	22,093	314	56
AP2-23-1232-3B	ApexPlus HP2 23Ghz, ETSI TR1232, 3B	23,011	23,325	314	56
AP2-23-1232-4A	ApexPlus HP2 23Ghz, ETSI TR1232, 4A	22,086	22,386	300	56
AP2-23-1232-4B	ApexPlus HP2 23Ghz, ETSI TR1232, 4B	23,318	23,618	300	56

AP1-23-1232-1A	ApexPlus HP 23Ghz, ETSI TR1232, 1A	21,200	21,500	300	56
AP1-23-1232-1B	ApexPlus HP 23Ghz, ETSI TR1232, 1B	22,432	22,732	300	56
AP1-23-1232-2A	ApexPlus HP 23Ghz, ETSI TR1232, 2A	21,472	21,786	314	56
AP1-23-1232-2B	ApexPlus HP 23Ghz, ETSI TR1232, 2B	22,704	23,018	314	56
AP1-23-1232-3A	ApexPlus HP 23Ghz, ETSI TR1232, 3A	21,779	22,093	314	56
AP1-23-1232-3B	ApexPlus HP 23Ghz, ETSI TR1232, 3B	23,011	23,325	314	56
AP1-23-1232-4A	ApexPlus HP 23Ghz, ETSI TR1232, 4A	22,086	22,386	300	56
AP1-23-1232-4B	ApexPlus HP 23Ghz, ETSI TR1232, 4B	23,318	23,618	300	56

Outdoor Unit Part Numbers	Description	TX Freq Min* (MHz)	TX Freq Max* (MHz)	Diplexer Range (MHz)	Max Chan Size (MHz)
------------------------------	-------------	-----------------------------	-----------------------------	----------------------------	------------------------------

### ApexPlus- 26 GHZ

AP2-26-0800-1A	ApexPlus HP2 26Ghz, ETSI TR800, 1A	24,250	24,450	200	56
AP2-26-0800-1B	ApexPlus HP2 26Ghz, ETSI TR800, 1B	25,050	25,250	200	56

AP1-26-0800-1A	ApexPlus HP 26Ghz, ETSI TR800, 1A	24,250	24,450	200	56
AP1-26-0800-1B	ApexPlus HP 26Ghz, ETSI TR800, 1B	25,050	25,250	200	56

AP2-26-1008-1A	ApexPlus HP2 26Ghz, ETSI TR1008, 1A	24,549	24,871	322	56
AP2-26-1008-1B	ApexPlus HP2 26Ghz, ETSI TR1008, 1B	25,557	25,879	322	56
AP2-26-1008-2A	ApexPlus HP2 26Ghz, ETSI TR1008, 2A	24,843	25,151	308	56
AP2-26-1008-2B	ApexPlus HP2 26Ghz, ETSI TR1008, 2B	25,851	26,159	308	56
AP2-26-1008-3A	ApexPlus HP2 26Ghz, ETSI TR1008, 3A	25,123	25,445	322	56
AP2-26-1008-3B	ApexPlus HP2 26Ghz, ETSI TR1008, 3B	26,131	26,453	322	56

AP1-26-1008-1A	ApexPlus HP 26Ghz, ETSI TR1008, 1A	24,549	24,885	336	56
AP1-26-1008-1B	ApexPlus HP 26Ghz, ETSI TR1008, 1B	25,557	25,893	336	56
AP1-26-1008-2A	ApexPlus HP 26Ghz, ETSI TR1008, 2A	24,829	25,165	336	56
AP1-26-1008-2B	ApexPlus HP 26Ghz, ETSI TR1008, 2B	25,837	26,173	336	56
AP1-26-1008-3A	ApexPlus HP 26Ghz, ETSI TR1008, 3A	25,109	25,445	336	56
AP1-26-1008-3B	ApexPlus HP 26Ghz, ETSI TR1008, 3B	26,117	26,453	336	56

### ApexPlus- 28 GHZ

AP1-28-1008-1A	ApexPlus HP 28Ghz, ETSI TR1008, 1A	27,520	28,025	505	56
AP1-28-1008-1B	ApexPlus HP 28Ghz, ETSI TR1008, 1B	28,528	29,033	505	56
AP1-28-1008-2A	ApexPlus HP 28Ghz, ETSI TR1008, 2A	27,968	28,473	505	56
AP1-28-1008-2B	ApexPlus HP 28Ghz, ETSI TR1008, 2B	28,976	29,481	505	56

AP1-28-1008-1A	ApexPlus HP 28Ghz, ETSI TR1008, 1A	27,520	28,025	505	56
AP1-28-1008-1B	ApexPlus HP 28Ghz, ETSI TR1008, 1B	28,528	29,033	505	56
AP1-28-1008-2A	ApexPlus HP 28Ghz, ETSI TR1008, 2A	27,968	28,473	505	56
AP1-28-1008-2B	ApexPlus HP 28Ghz, ETSI TR1008, 2B	28,976	29,481	505	56

AP2-28-0450-1A	ApexPlus HP 28Ghz, ETSI TR450, 1A	27,500	57,680	180	180
AP2-28-0450-1B	ApexPlus HP 28Ghz, ETSI TR450, 1B	27,950	28,130	180	180
AP2-28-0450-2A	ApexPlus HP 28Ghz, ETSI TR450, 2A	27,610	27,790	180	180
AP2-28-0450-2B	ApexPlus HP 28Ghz, ETSI TR450, 2B	28,060	28,240	180	180
AP2-28-0450-3A	ApexPlus HP 28Ghz, ETSI TR450, 3A	27,720	27,900	180	180
AP2-28-0450-3B	ApexPlus HP 28Ghz, ETSI TR450, 3B	28,170	28,350	180	180

### ApexPlus- 32 GHZ

AP1-32-0812-1A	ApexPlus HP 32Ghz, ETSI TR812, 1A	31,815	32,207	392	56
AP1-32-0812-1B	ApexPlus HP 32Ghz, ETSI TR812, 1B	32,627	33,019	392	56
AP1-32-0812-2A	ApexPlus HP 32Ghz, ETSI TR812, 2A	32,179	32,571	392	56
AP1-32-0812-2B	ApexPlus HP 32Ghz, ETSI TR812, 2B	32,991	33,383	392	56

### ApexPlus- 38 GHZ

AP1-38-0700-1A	ApexPlus HP 38Ghz, ANS/ETSI TR700, 1A	38,595	38,805	210	56
AP1-38-0700-1B	ApexPlus HP 38Ghz, ANS/ETSI TR700, 1B	39,295	39,505	210	56
AP1-38-0700-2A	ApexPlus HP 38Ghz, ANS/ETSI TR700, 2A	38,795	39,005	210	56
AP1-38-0700-2B	ApexPlus HP 38Ghz, ANS/ETSI TR700, 2B	39,495	39,705	210	56
AP1-38-0700-3A	ApexPlus HP 38Ghz, ANS/ETSI TR700, 3A	38,995	39,205	210	56
AP1-38-0700-3B	ApexPlus HP 38Ghz, ANS/ETSI TR700, 3B	39,695	39,905	210	56
AP1-38-0700-4A	ApexPlus HP 38Ghz, ANS/ETSI TR700, 4A	39,195	39,405	210	56
AP1-38-0700-4B	ApexPlus HP 38Ghz, ANS/ETSI TR700, 4B	39,895	40,105	210	56

AP2-38-1260-1A	ApexPlus HP2 38Ghz ETSI TR1260, 1A	37,044	37,632	588	56
AP2-38-1260-1B	ApexPlus HP2 38Ghz ETSI TR1260, 1B	38,304	38,892	588	56
AP2-38-1260-2A	ApexPlus HP2 38Ghz ETSI TR1260, 2A	37,604	38,192	588	56
AP2-38-1260-2B	ApexPlus HP2 38Ghz ETSI TR1260, 2B	38,864	39,452	588	56

AP1-38-1260-1A	ApexPlus HP 38Ghz, ANS/ETSI TR1260, 1A	37,044	37,632	588	56
AP1-38-1260-1B	ApexPlus HP 38Ghz, ANS/ETSI TR1260, 1B	38,304	38,892	588	56
AP1-38-1260-2A	ApexPlus HP 38Ghz, ANS/ETSI TR1260, 2A	37,604	38,192	588	56
AP1-38-1260-2B	ApexPlus HP 38Ghz, ANS/ETSI TR1260, 2B	38,864	39,452	588	56

\* Frequencies shown are NOT center frequencies, but rather the edge of the transmit band. Center frequency limits are 1/2 the channel bandwidth away from these numbers.

## Accessories

TRANGO PtP MICROWAVE BAND SPECIFIC ACCESSORIES							
Model	Antenna	3/3 dB Dir Mnt Comb	1.9/6 dB Dir Mnt Comb	Dir Mnt Ortho Comb	Remote Mount	Rem Mnt 3/3 dB Comb	Rem Mnt 1.9/6 dB Comb

### ApexPlus- 6 GHZ

AP1-06-0240-xx	AD6GL-xx-R2, -R3	SMC-06-3-HP	SMC-06-6-HP	OMC-06-HP	HP-MNT-06-WR137	SMC-06-3-HP-R	SMC-06-6-HP-R
AP1-06-0252-xx	AD6GL-xx-R2, -R3	SMC-06-3-HP	SMC-06-6-HP	OMC-06-HP	HP-MNT-06-WR137	SMC-06-3-HP-R	SMC-06-6-HP-R
AP1-06-0340-xx	AD6GU-xx-R2, -R3	SMC-06-3-HP	SMC-06-6-HP	OMC-06-HP	HP-MNT-06-WR137	SMC-06-3-HP-R	SMC-06-6-HP-R
AP2-06-0160-xx	AD6GU-xx-R4, -R3	SMC-06-3-HP2	SMC-06-6-HP2	OMC-06-HP2	HP2-MNT-6-WR137	SMC-06-3-HP-R	SMC-06-6-HP-R
AP2-06-0170-xx	AD6GU-xx-R4, -R3	SMC-06-3-HP2	SMC-06-6-HP2	OMC-06-HP2	HP2-MNT-6-WR137	SMC-06-3-HP-R	SMC-06-6-HP-R
AP2-06-0252-xx	AD6GL-xx-R4, -R3	SMC-06-3-HP2	SMC-06-6-HP2	OMC-06-HP2	HP2-MNT-6-WR137	SMC-06-3-HP-R	SMC-06-6-HP-R
AP2-06-0300-xx	AD6GL-xx-R4, -R3	SMC-06-3-HP2	SMC-06-6-HP2	OMC-06-HP2	HP2-MNT-6-WR137	SMC-06-3-HP-R	SMC-06-6-HP-R
AP2-06-0340-xx	AD6GU-xx-R4, -R3	SMC-06-3-HP2	SMC-06-6-HP2	OMC-06-HP2	HP2-MNT-6-WR137	SMC-06-3-HP-R	SMC-06-6-HP-R
AP2-06-0350-xx	AD6GU-xx-R4, -R3	SMC-06-3-HP2	SMC-06-6-HP2	OMC-06-HP2	HP2-MNT-6-WR137	SMC-06-3-HP-R	SMC-06-6-HP-R

Note: All -R3 Antennas require a Remote Mount for the ODU and Waveguide

### ApexPlus- 7 GHZ

AP1-07-xxxx-xx	AD7G-xx-S2	SMC-78-3-HP	SMC-78-6-HP	OMC-07-HP	HP-MNT-78-WR112	SMC-78-3-HP-R	SMC-78-6-HP-R
AP2-07-xxxx-xx	AD7G-xx-S2	SMC-78-3-HP	SMC-78-6-HP	OMC-07-HP	HP-MNT-78-WR112	SMC-78-3-HP-R	SMC-78-6-HP-R

### ApexPlus- 8 GHZ

AP1-08-xxxx-xx	AD8G-xx-R2	SMC-78-3-HP	SMC-78-6-HP	OMC-07-HP	HP-MNT-78-WR112	SMC-78-3-HP-R	SMC-78-6-HP-R
AP2-08-xxxx-xx	AD8G-xx-R2	SMC-78-3-HP	SMC-78-6-HP	OMC-07-HP	HP-MNT-78-WR112	SMC-78-3-HP-R	SMC-78-6-HP-R

### ApexPlus- 10 GHZ

AP2-10-xxxx-xx	AD10G-xx-S2	NA	NA	NA	NA	NA	NA
----------------	-------------	----	----	----	----	----	----

### ApexPlus- 11 GHZ

AP1-11-xxxx-xx	AD11G-xx-S2, -R2	SMC-11-3-HP	SMC-11-6-HP	OMC-11-HP	HP-MNT-11-WR75	SMC-11-3-HP-R	SMC-11-6-HP-R
AP2-11-xxxx-xx	AD11G-xx-S2, -R2	SMC-11-3-HP	SMC-11-6-HP	OMC-11-HP	HP-MNT-11-WR75	SMC-11-3-HP-R	SMC-11-6-HP-R

### ApexPlus- 13 GHZ

AP1-13-xxxx-xx	AD13G-xx-S2, -R2	SMC-13-3-HP	SMC-13-6-HP	OMC-13-HP	HP-MNT-13-WR75	SMC-13-3-HP-R	SMC-13-6-HP-R
AP2-13-xxxx-xx	AD13G-xx-S2, -R2	SMC-13-3-HP	SMC-13-6-HP	OMC-13-HP	HP-MNT-13-WR75	SMC-13-3-HP-R	SMC-13-6-HP-R

### ApexPlus- 15GHZ

AP1-15-xxxx-xx	AD15G-xx-S2	SMC-15-3-HP	SMC-15-6-HP	OMC-15-HP	HP-MNT-15-WR62	SMC-15-3-HP-R	SMC-15-6-HP-R
AP2-15-xxxx-xx	AD15G-xx-S2	SMC-15-3-HP	SMC-15-6-HP	OMC-15-HP	HP-MNT-15-WR62	SMC-15-3-HP-R	SMC-15-6-HP-R

### ApexPlus- 18 GHZ

AP1-18-xxxx-xx	AD18G-xx-S2, R2	SMC-18-3-HP	SMC-18-6-HP	OMC-18-HP	HP-MNT-18-WR42	SMC-18-3-HP-R	SMC-18-6-HP-R
AP2-18-xxxx-xx	AD18G-xx-S2, R2	SMC-18-3-HP	SMC-18-6-HP	OMC-18-HP	HP-MNT-18-WR42	SMC-18-3-HP-R	SMC-18-6-HP-R

### ApexPlus- 23 GHZ

AP1-23-xxxx-xx	AD23G-xx-S2, -R2	SMC-23-3-HP	SMC-23-6-HP	OMC-23-HP	HP-MNT-23-WR42	SMC-23-6-HP-R	SMC-26-3-HP-R
AP2-23-xxxx-xx	AD23G-xx-S2, -R2	SMC-23-3-HP	SMC-23-6-HP	OMC-23-HP	HP-MNT-23-WR42	SMC-23-6-HP-R	SMC-26-3-HP-R

### ApexPlus- 26 GHZ

AP1-26-xxxx-xx	AD26G-xx-S2	SMC-26-3-HP	SMC-26-6-HP	NA	HP-MNT-26-WR42	SMC-26-3-HP-R	SMC-26-6-HP-R
AP2-26-xxxx-xx	AD26G-xx-S2	SMC-26-3-HP	SMC-26-6-HP	NA	HP-MNT-26-WR42	SMC-26-3-HP-R	SMC-26-6-HP-R

### ApexPlus- 26 GHZ

AP1-28-xxxx-xx	AD28G-xx-R2	SMC-28-3-HP	SMC-28-6-HP	NA	HP-MNT-28-WR28	SMC-28-3-HP-R	SMC-28-6-HP-R
----------------	-------------	-------------	-------------	----	----------------	---------------	---------------

### ApexPlus- 32 GHZ

AP1-32-xxxx-xx	AD32G-xx-R2	SMC-32-3-HP	SMC-32-6-HP	NA	HP-MNT-32-WR28	SMC-32-3-HP-R	SMC-32-6-HP-R
----------------	-------------	-------------	-------------	----	----------------	---------------	---------------

### ApexPlus- 38 GHZ

AP1-38-xxxx-xx	AD38G-xx-R2	SMC-38-3-HP	SMC-38-6-HP	OMC-38-HP	HP-MNT-38-WR28	SMC-38-3-HP-R	SMC-38-6-HP-R
AP1-38-xxxx-xx	AD38G-xx-R2	SMC-38-3-HP	SMC-38-6-HP	OMC-38-HP	HP-MNT-38-WR28	SMC-38-3-HP-R	SMC-38-6-HP-R
AP2-38-xxxx-xx	AD38G-xx-R2	SMC-38-3-HP	SMC-38-6-HP	OMC-38-HP	HP-MNT-38-WR28	SMC-38-3-HP-R	SMC-38-6-HP-R

## ***Appendix F – Link Install and Commissioning Logs***

Standardized forms are provided here for use during the installation and configuration phase and to serve as a record of the link performance at the time of installation.

## Site Information

Customer:	
Site Name:	
Site Address:	
Site Coordinate:	
Radio Model:	
Radio Serial #	
Site Access notes:	

## Antenna Information

Antenna model	
Antenna size	
Height above Ground Level	
Does it meet Fresnel zone requirement?	Yes No
Antenna Mount is properly secure?	Yes No
Is the Antenna properly secure?	Yes No
Is the Mount Properly grounded?	Yes No
Is the Antenna Properly grounded?	Yes No
Is the Antenna side strut installed?	Yes No
Is the Antenna weather proof?	Yes No
Was the O-Ring installed properly?	Yes No

## Outdoor Unit Information

Model of ODU :		
Direct or Remote ODU Mount	Direct	Remote
Are all four latches properly closed?	Yes	No
What is the ODU polarization?	H	V
Does the ODU look damaged?	Yes	No
Is the Gore Vent damaged?	Yes	No

## PoE Information (Optional)

Is PoE Properly grounded to Earth Ground	Yes	No
Cat 5e or Cat 6 Shielded Twisted Pair used on PoE-GigE-48 to ODU connections (Data and Management Ports)	Yes	No
Are the Strain Reliefs for the cables tight	Yes	No
Are all cables properly labeled and secure?	Yes	No
Was a pull test conducted on the terminal block to ensure that the wires are secure?	Yes	No

## Power Supply Information

Type of power Supply:		
Redundant power to the ODU or PoE?	Yes	No
Measure input voltage at PoE		(-VDC)
Properly grounded to the Earth?	Yes	No
Are the leads properly terminated to the power supply's terminal block	Yes	No

## Ethernet/Fiber Cable Information

Cable type:		
Cable Length:		
Secure connection to the PoE with no tabs missing?		
Secure connection to the ODU with no tabs missing?		
Proper weather proofing at all necessary Points?	Yes	No
	Remarks:	
Point of entry properly weather proof?	Yes	No
Point of entry properly grounded?	Yes	No
Is there a drip loop at the ODU?	Yes	No
Is cable properly secure?	Yes	No
Is there any damage to the cable, bends, kinks, etc.?	Yes	No
	Remarks:	



**Notes:**

--

**Installation Performed by:**

Name:	Date:
Title:	Contact Number:
Company:	Signature:

**Installation Approved by:**

Name:	Date:
Title:	Contact Number:
Company:	Signature:

## Link Configuration Log

Site A Information	
Customer:	
Site Name:	
Site Address:	
Site Coordinate:	
Site Configuration:	1+0/ 1+1 / 2+0 (Circle One)
Site Access notes:	

Complete after Link Configuration completed

Site A Configuration Performed by:	
Name:	Date:
Title:	Contact Number:
Company:	Signature:

Site A Configuration Approved by:	
Name:	Date:
Title:	Contact Number:
Company:	Signature:

## Site A Outdoor Unit #1 Information

Model of ODU	
ODU Serial Number	
OMU Serial Number	
OMU MAC Address	
OMU IP Address	OBM: IBM:
Polarization of this unit	V or H
Antenna Model	
Antenna Serial Number	
Transmit Frequency Setting	MHz
Transmit Power Setting	dBm
Speed/Modulation Setting	
Adaptive Coding & Modulation	ON / OFF
Automatic Transmit Power Control	ON / OFF
Target RSSI Setting	dBm
Recorded RSSI	dBm
Expected RSSI from PCN	dBm
Recorded MSE	dB
Linktest 99: stable RSSI, MSE, Lock?	Yes / No
24 Hour Traffic Test	No Errors –Pass / Errors: Fail
Utype	Active/Standby

Site A Outdoor Unit #2 Information	
Model of ODU	
ODU Serial Number	
OMU Serial Number	
OMU MAC Address	
OMU IP Address	OBM: IBM:
Polarization of this unit	V or H
<b>Combiner</b> Model	
<b>Combiner</b> Serial Number	
Transmit Frequency Setting	MHz
Transmit Power Setting	dBm
Speed/Modulation Setting	
Adaptive Coding & Modulation	ON / OFF
Automatic Transmit Power Control	ON / OFF
Target RSSI Setting	dBm
Recorded RSSI	dBm
Expected RSSI from PCN	dBm
Recorded MSE	dB
Linktest 99: stable RSSI, MSE, Lock?	Yes / No
24 Hour Traffic Test	No Errors –Pass / Errors: Fail
Utype	Active/Standby

Site B Information	
Customer:	
Site Name:	
Site Address:	
Site Coordinate:	
Site Configuration:	1+0/ 1+1 / 2+0 (Circle One)
Site Access notes:	

Complete after Link Configuration completed

Site B Configuration Performed by:	
Name:	Date:
Title:	Contact Number:
Company:	Signature:

Site B Configuration Approved by:	
Name:	Date:
Title:	Contact Number:
Company:	Signature:

## Site B Outdoor Unit #1 Information

Model of ODU	
ODU Serial Number	
OMU Serial Number	
OMU MAC Address	
OMU IP Address	OBM: IBM:
Polarization of this unit	V or H
Antenna Model	
Antenna Serial Number	
Transmit Frequency Setting	MHz
Transmit Power Setting	dBm
Speed/Modulation Setting	
Adaptive Coding & Modulation	ON / OFF
Automatic Transmit Power Control	ON / OFF
Target RSSI Setting	dBm
Recorded RSSI	dBm
Expected RSSI from PCN	dBm
Recorded MSE	dB
Linktest 99: stable RSSI, MSE, Lock?	Yes / No
24 Hour Traffic Test	No Errors –Pass / Errors: Fail
Utype	Active/Standby

Site B Outdoor Unit #2 Information	
Model of ODU	
ODU Serial Number	
OMU Serial Number	
OMU MAC Address	
OMU IP Address	OBM: IBM:
Polarization of this unit	V or H
<b>Combiner</b> Model	
<b>Combiner</b> Serial Number	
Transmit Frequency Setting	MHz
Transmit Power Setting	dBm
Speed/Modulation Setting	
Adaptive Coding & Modulation	ON / OFF
Automatic Transmit Power Control	ON / OFF
Target RSSI Setting	dBm
Recorded RSSI	dBm
Expected RSSI from PCN	dBm
Recorded MSE	dB
Linktest 99: stable RSSI, MSE, Lock?	Yes / No
24 Hour Traffic Test	No Errors –Pass / Errors: Fail
Utype	Active/Standby

# Appendix G – Declaration of Conformity

We, Trango Systems, Inc.,

14118 Stowe Drive  
Ste B  
Poway, California, 92127 USA  
Tel +1 858 391-0010  
Fax +1 858 391-0020

Hereby declare that the product(s) listed below,

**Product Name:** *TrangoLINK ApexPLUS All Outdoor Unit, 100Mbps*

**Model No:** *AP1-XX-YYYY-ZZ, AP2-XX-YYYY-ZZ*

*Where:*

*XX = the Frequency Band in GHz*

*YYYY= the T/R Spacing*

*ZZ= the Sub-band*

to which this declaration relates, are in conformity with the following standards and/or other normative documents:

*EN 302 217-2-2 (2007-04)*

*EN 302 217-2-1 (2005-08)*

*EN 301 489-17 v1.2.1 (2002-08)*

*EN 60950-1/IEC 60950-1:2001 First Edition*

*EN 50385: 2002*

We hereby declare that all essential radio test suites have been carried out and that the above named products are in conformity with all the essential requirements of Directive 1999/5/EC.

The conformity assessment procedure referred to in Article 10(5) and detailed in Annex IV of Directive 1999/5/EC has been followed with the involvement of the following Notified Body using the CB Scheme:





## ***Glossary***

AGC	Automatic Gain Control
ATPC	Automatic Transmit Power Control
BER	Bit Error Rate
BPF	Band Pass Filter
Cat5e	Category 5 enhanced Cable
COS	Class Of Service
dB	Decibel
dBm	Decibel relative to one milliwatt
E1	European-Carrier 1
FCC	Federal Communication Commission
FEC	Forward Error Correction
FPGA	Field Programmable Gate-Array
FTP	File Transfer Protocol
GigE	Gigabit Ethernet
HTTP	HyperText Transfer Protocol
HTTPD	HyperText Transfer Protocol Daemon
HTTPS	HyperText Transfer Protocol Secure
IF	Intermediate Frequency
LB	Loopback
LDPC	Low Density Parity Check
LED	Light-emitting Diode
LIU	Line Interface Unit
MSE	Mean Square Error
ODU	Outdoor Unit
OMU	Outdoor Modem Unit
Opmode	Operation Mode
OS	Operating System
PIC	A Series of microcontrollers a product of the Microchip Technology
PoE	Power Over Ethernet
QAM	Quadrature Amplitude Modulation
QoS	Quality of Service
QPSK	Quadrature Phase Shift Keying
RF	Radio Frequency
RJ-45	Registered Jack - 45
RS-232	Recommended Standard 232
RSSI	Receive Signal Strength Indicator
Rx	Receive
SFP	Small Form-factor Pluggable
SNMP	Simple Network Management Protocol
SSH	Secure Shell
Sysinfo	System Information

T1	1.544 Mbps telephony carrier 1
TDM	Time-Division Multiplexing
T/I	Threshold to Interference
TFTP	Trivial File Transfer Protocol
TFTPD	Trivial File Transfer Protocol Daemon
Tx	Transmit
VLAN	Virtual Local Area Network
WISP	Wireless Internet Service Provider